



UNITED STATES
 CONSUMER PRODUCT SAFETY COMMISSION
 4330 EAST WEST HIGHWAY
 BETHESDA, MD 20814

This document has been electronically approved and signed.

**THIS MATTER IS NOT SCHEDULED FOR A BALLOT VOTE
 BRIEFING AND DECISIONAL MEETINGS FOR THIS MATTER ARE TO BE
 DETERMINED**

DATE: October 6, 2021

TO: The Commission
 Alberta E. Mills, Secretary

THROUGH: Pamela J. Stone, Acting General Counsel
 Mary T. Boyle, Executive Director

FROM: Daniel R. Vice, Assistant General Counsel, Regulatory Affairs
 Meridith L. Kelsch, Attorney, Regulatory Affairs

SUBJECT: Proposed Rule: Safety Standard for Magnets

Staff is forwarding to the Commission a briefing package recommending that the Commission issue a notice of proposed rulemaking (NPR), pursuant to section 7 and 9 of the Consumer Product Safety Act, to address the risk of injury associated with ingestion of small high-powered magnets. The Office of the General Counsel is providing for the Commission's consideration a draft NPR that would establish requirements for subject magnet products.

Please indicate your vote on the following options:

- I. Approve publication of the attached notice in the *Federal Register*, as drafted.

 (Signature) (Date)

- II. Approve publication of the attached notice in the *Federal Register*, with the specified changes.

 (Signature) (Date)

III. Do not approve publication of the attached notice in the *Federal Register*.

(Signature)

(Date)

IV. Take other action specified below.

(Signature)

(Date)

Attachment: Draft *Federal Register* Notice: Safety Standard for Magnets

Billing Code 6355-01-P

CONSUMER PRODUCT SAFETY COMMISSION

16 CFR Parts 1112 and 1262

[Docket No. CPSC-XXXX-XXXX]

Safety Standard for Magnets

AGENCY: Consumer Product Safety Commission.

ACTION: Notice of proposed rulemaking.

SUMMARY: The U.S. Consumer Product Safety Commission (Commission or CPSC) has determined preliminarily that there is an unreasonable risk of injury and death, particularly to children and teens, associated with ingestion of one or more high-powered magnets. To address this risk, the Commission proposes a rule, under the Consumer Product Safety Act, to apply to consumer products that are designed, marketed, or intended to be used for entertainment, jewelry (including children’s jewelry), mental stimulation, stress relief, or a combination of these purposes, and that contain one or more loose or separable magnets. Toys that are subject to CPSC’s mandatory toy standard are exempt from the proposed rule. Each loose or separable magnet in a product that is subject to the proposed rule and that fits entirely within CPSC’s small parts cylinder would be required to have a flux index of less than $50 \text{ kG}^2 \text{ mm}^2$. The Commission requests comments about all aspects of this notice, including the risk of injury, the proposed scope and requirements, alternatives to the proposed rule, and the economic impacts of the proposed rule and alternatives.

DATES: Submit comments by [INSERT DATE 75 DAYS AFTER DATE OF PUBLICATION IN THE FEDERAL REGISTER].

ADDRESSES: Submit written comments, identified by Docket No. CPSC-XXXX-XXXX, using the methods described below. CPSC encourages you to submit comments electronically, rather than in hard copy.

Electronic Submissions: Submit electronic comments to the Federal eRulemaking Portal at: <https://www.regulations.gov>. Follow the instructions for submitting comments. CPSC does not accept comments submitted by electronic mail (e-mail), except through <https://www.regulations.gov>, and as described below. CPSC encourages you to submit electronic comments by using the Federal eRulemaking Portal, as described above.

Mail/Hand Delivery/Courier Written Submissions: Submit comments by mail/hand delivery/courier to: Division of the Secretariat, Consumer Product Safety Commission 4330 East West Highway, Bethesda, MD 20814; telephone: (301) 504-7479. Alternatively, as a temporary option during the COVID-19 pandemic, you can e-mail such submissions to: cpsc-os@cpsc.gov.

Instructions: All submissions must include the agency name and docket number for this notice. CPSC may post all comments without change, including any personal identifiers, contact information, or other personal information provided, to: <https://www.regulations.gov>. Do not submit electronically: confidential business information, trade secret information, or other sensitive or protected information that you do not want to be available to the public. If you wish to submit such information, please submit it according to the instructions for mail/hand delivery/courier written submissions.

Docket: To read background documents or comments regarding this proposed rulemaking, go to: <http://www.regulations.gov>, insert docket number CPSC-XXXX-XXXX in the “Search” box, and follow the prompts.

FOR FURTHER INFORMATION CONTACT: Michelle Guice, Compliance Officer, U.S. Consumer Product Safety Commission, 4330 East West Highway, Bethesda, MD 20814; telephone (301) 504-7723; e-mail: MGuice@cpsc.gov.

SUPPLEMENTARY INFORMATION:

I. Background

A. Overview of the Proposed Rule

The Commission issues this notice of proposed rulemaking (NPR) under sections 7 and 9 of the Consumer Product Safety Act (CPSA; 15 U.S.C. 2051-2089). Through this rulemaking, the Commission seeks to create a safety standard to address the unreasonable risk of injury and death associated with ingestion of loose or separable high-powered magnets. Incident data indicate that certain consumer products containing such magnets are ingested by children and teens. When ingested, these powerful magnets can interact internally with one another, or a ferromagnetic object (*i.e.*, material attracted to magnets), through body tissue, leading to acute and long-term adverse health consequences or death.

The proposed rule applies to consumer products that are designed, marketed, or intended to be used for entertainment, jewelry (including children’s jewelry), mental stimulation, stress relief, or a combination of these purposes, and that contain one or more loose or separable magnets. Toys that are subject to CPSC’s mandatory toy standard in 16 CFR part 1250 are exempt from the proposed rule, because that standard already includes requirements to address the magnet ingestion hazard in children’s toys (*i.e.*, products designed, manufactured, or marketed as playthings for children under 14 years old). In this notice, products that are subject to the proposed rule are referred to as “subject magnet products.”

The proposed rule seeks to address the risk of injury or death associated with magnet ingestions, by requiring loose or separable magnets in subject magnet products to be either too large to swallow, or weak enough to reduce the risk of internal interaction injuries when swallowed. Under the proposed rule, each loose or separable magnet in a subject magnet product that fits entirely within CPSC’s small parts cylinder must have a flux index of less than 50 kG² mm². CPSC’s small parts cylinder is described and illustrated in 16 CFR 1501.4, which is intended to prevent children from ingesting of small objects. The proposed rule specifies the method for determining the flux index of a magnet, and this preamble discusses the basis for the flux index limit in the proposed rule. The term “hazardous magnet” refers to a magnet that fits entirely within the small parts cylinder and that has a flux index of 50 kG² mm² or more.

The information discussed in this preamble is derived from CPSC staff’s briefing package for the NPR, which is available on CPSC’s website at: XXXX. This preamble provides key information to explain and support the rule; however, for a more comprehensive and detailed discussion, see the NPR briefing package.¹

B. History of CPSC Work on the Magnet Ingestion Hazard

CPSC has taken several actions to address the magnet ingestion hazard, including issuing mandatory standards, working with voluntary standards organizations, initiating recalls and compliance actions, engaging in staff assessments of the hazard and potential ways to address it, and creating information campaigns.

1. Mandatory Standards

On August 14, 2008, Congress enacted section 106 of the Consumer Product Safety Improvement Act (CPSIA; Pub. L. No. 110-314, 122 Stat. 3016 (Aug. 14, 2008)), codified at 15

¹ Available at: XX

U.S.C. 2056b. Section 106 of the CPSIA provides that, beginning 180 days after its enactment, ASTM F963-07, *Consumer Safety Specification for Toy Safety*, is considered a consumer product safety standard issued by the Commission under section 9 of the CPSA.² 15 U.S.C. 2056b(a). Section 106 further provides for updates to the mandatory standard when ASTM F963 is revised or to improve safety. *Id.* 2056b(b)(2), (c), (d), (g). Section 106 specifically refers to “internal harm or injury hazards caused by the ingestion or inhalation of magnets in children’s products,” among other hazards, in its directive to review and assess ASTM F963. *Id.* 2056b(b)(1)(A).

Consistent with the mandate in section 106 of the CPSIA, the Commission adopted 16 CFR part 1250, *Safety Standard Mandating ASTM F963 for Toys* (toy standard), which currently incorporates by reference ASTM F963-17, the most recent revision to the standard.³ 82 Fed. Reg. 57119 (Dec. 4, 2017). ASTM F963-17 applies to “toys,” which are objects “designed, manufactured, or marketed as a plaything for children under 14 years of age.” The standard includes requirements to address the hazard associated with ingestion of loose, as-received magnets that are small enough to fit in the small parts cylinder and have a flux index of 50 kG² mm² or more. Section **V. Relevant Existing Standards**, below, further describes the requirements in ASTM F963-17.

In 2012, the Commission initiated rulemaking to address the magnet ingestion hazard for products that do not fall under 16 CFR part 1250. The rule focused on magnet sets, which were

² Section 106 excluded from this mandate the following provisions in ASTM F963-07: section 4.2 and Annex 4 (which address flammability), and “any provision that restates or incorporates an existing mandatory standard or ban promulgated by the Commission or by statute or any provision that restates or incorporates a regulation promulgated by the Food and Drug Administration or any statute administered by the Food and Drug Administration.”

³ Part 1250 excepts from the mandatory standard, section 4.2 and Annex 5 (which address flammability) of ASTM F963-17, as well as “any provision of ASTM F963 that restates or incorporates an existing mandatory standard or ban promulgated by the Commission or by statute or any provision that restates or incorporates a regulation promulgated by the Food and Drug Administration or any statute administered by the Food and Drug Administration.” 16 CFR 1250.2(b). In addition, part 1250 replaces section 8.20.1.5(5) of ASTM F963 regarding floor and tabletop toys that move, where a sound is caused as a result of the movement imparted on the toy. *Id.* 1250.2(c).

involved in internal interaction injuries in children and teens, when ingested. 77 Fed. Reg. 53781 (Sep. 4, 2012) (notice of proposed rulemaking); 79 Fed. Reg. 59962 (Oct. 3, 2014) (final rule). The rule defined “magnet sets” as “any aggregation of separable magnetic objects that is a consumer product intended, marketed or commonly used as a manipulative or construction item for entertainment, such as puzzle working, sculpture building, mental stimulation, or stress relief.” The rule required each magnet in a magnet set, and each individual magnetic object intended or marketed for use with or as a magnet set, that fit completely within CPSC’s small parts cylinder, to have a flux index of $50 \text{ kG}^2 \text{ mm}^2$ or less. The final rule was published in October 2014, and it took effect on April 1, 2015. On November 22, 2016, the U.S. Court of Appeals for the Tenth Circuit overturned the rule on magnet sets, vacating and remanding the rule to the Commission. *Zen Magnets, LLC v. Consumer Prod. Safety Comm’n.*, 841 F.3d 1141 (10th Cir. 2016).⁴

2. *Voluntary Standards Work*

CPSC staff has actively participated in the development and revision of voluntary standards intended to address the magnet ingestion hazard. Since the development of ASTM F963 in 2007, CPSC staff has worked with ASTM to address hazardous magnets in children’s toys, including working on multiple revisions to that standard. In addition, staff has participated actively in the ASTM Subcommittee F15.77 on Magnets, which published a voluntary standard on magnet sets in March 2021—ASTM F3458-21, *Standard Specification for Marketing, Packaging, and Labeling Adult Magnet Sets Containing Small, Loose, Powerful Magnets (with a Flux Index $\geq 50 \text{ kG}^2 \text{ mm}^2$)*.

⁴ The court decision had legal effect immediately upon its filing on November 22, 2016. However, in accordance with the court’s decision, the Commission removed the mandatory standard for magnets sets (16 CFR part 1240) from the Code of Federal Regulations on March 7, 2017. 82 Fed. Reg. 12716 (Mar. 7, 2017).

3. *Recalls and Compliance Actions*⁵

CPSC's Office of Compliance has investigated and recalled numerous magnet products involving the magnet ingestion hazard. From January 1, 2010 through August 17, 2021, CPSC conducted 18 such recalls, involving 23 firms/retailers, and totaling approximately 13,832,899 recalled units, including craft kits, desk toys, magnet sets, pencil cases, games, bicycle helmets, and maps, among others. Of these 18 recalls, 5 involved products that would not be subject to the proposed rule; specifically, 4 involved children's toys that are subject to the mandatory toy standard, and 1 involved trivets sold with cookware sets. Although these 5 recalls did not apply to products that would be subject to the rule, they also illustrate the magnet ingestion hazard. In addition to recalls, CPSC has addressed the products that present a magnet ingestion hazard through manufacturers' voluntary cessation of sales.

4. *Staff Assessment*

In addition to staff's assessments of the magnet ingestion hazard for previous rulemakings and compliance efforts, staff also assessed the hazard and potential ways to address it in response to a petition for rulemaking. On August 17, 2017, CPSC received a petition requesting that the Commission initiate rulemaking to address the hazard associated with magnet sets when "ingested, aspirated, or otherwise inserted into" the body.⁶ On April 22, 2020, the petitioner withdrew the petition. Nevertheless, staff provided the Commission with an informational briefing package on June 30, 2020, discussing the hazard and staff's work in response to the petition.⁷ In the informational briefing package, staff recommended that CPSC

⁵ Tab G of the NPR briefing package provides details about the recall dates, hazards, approximate number of units affected, number of reported incidents and injuries, and links to the recall press releases.

⁶ The Commission published a *Federal Register* notice on October 6, 2017, seeking comments on the petition. 82 Fed. Reg. 46740.

⁷ The informational briefing package, "Staff Briefing Package In Response to Petition CP 17-1, Requesting Rulemaking Regarding Magnet Sets," is available at: <https://www.cpsc.gov/s3fs-public/Informational%20Briefing%20Package%20Regarding%20Magnet%20Sets.pdf>.

continue to consider performance requirements for magnets, to address the ingestion hazard to children and teens.

5. Information Campaigns

In addition to raising awareness of the magnet ingestion hazard through publicized recalls, CPSC has drawn attention to the hazard through safety alerts and public safety bulletins. CPSC maintains a “Magnets Information Center” website,⁸ which provides an informational video, a description of the hazard, steps to take when magnets are swallowed, and links to recalls, relevant CPSC materials, applicable regulations, and informational posters. CPSC also issued a safety alert about the magnet ingestion hazard, which describes the hazard and steps to take when magnets are swallowed. In addition to CPSC’s information campaigns, health organizations and other consumer advocacy groups have made numerous public outreach efforts to warn consumers about the magnet ingestion hazard.⁹

C. How Other Countries Have Addressed the Magnet Ingestion Hazard

Like CPSC, other countries have recognized the internal interaction hazard associated with magnet ingestions. Several of these countries have issued mandatory requirements to address the hazard. To understand how other countries have addressed magnet ingestions, staff reviewed the mandatory requirements for Canada, Australia, New Zealand, and the European Commission.

⁸ Available at: <https://www.cpsc.gov/Safety-Education/Safety-Education-Centers/Magnets>.

⁹ Examples include the American Academy of Pediatrics (<https://services.aap.org/en/search/?k=magnets>); the North American Society for Pediatric Gastroenterology, Hepatology and Nutrition (<https://www.naspghan.org/content/72/en/Foreign-Body-Ingestion>); Consumer Reports (<https://www.consumerreports.org/product-safety/magnets-marketed-as-toys-could-be-dangerous-to-kids/>); Consumer Federation of America (<https://consumerfed.org/testimonial/cfa-comments-cpsc-notice-proposed-rulemaking-safety-standard-magnet-sets/>); and Kids In Danger (<https://kidsindanger.org/2011/11/cpsc-warns-about-high-powered-magnets/>).

Canada's Requirements Regarding Magnet Ingestion. Since 2006, Health Canada has issued several advisories to warn Canadians of the dangers associated with ingesting magnets.¹⁰ In addition, some manufacturers took steps to keep these products from children (*e.g.*, through package warnings, instructions on safe use, and guidance to retailers on safe sales practices). Despite these efforts, children continued to access and use magnets, and ingestion incidents continued. Consequently, Canada adopted mandatory standards for toys and non-toys, to address the magnet ingestion hazard.

Canada's regulation for toys, SOR/2018-138, includes requirements for magnetic toys intended for children under 14 years old.¹¹ The standard requires each magnet toy, and each magnetic component in a toy, that can fit entirely within a small parts cylinder, to have a flux index below a specified limit, which is equivalent to 50 kG² mm². The standard includes toys with only one magnet, to account for attraction to ferromagnetic objects. The requirements are consistent with ASTM F963.

Canada has also specified¹² that its general requirements, under the Canada Consumer Product Safety Act (CCPSA), prohibit the manufacture, import, advertising, and sale of products that contain small, powerful magnets, regardless of the intended user age. The general provision in the CCPSA prohibits the manufacture, import, advertisement, and sale of any consumer product that "is a danger to human health or safety." Sections 7(a), 8(a).¹³ Canada specifically

¹⁰ For example, see: <https://healthycanadians.gc.ca/recall-alert-rappel-avis/hc-sc/2013/31619a-eng.php>; <https://www.canada.ca/en/health-canada/services/consumer-product-safety/advisories-warnings-recalls/letters-notices-information-industry/information-manufacturers-importers-distributors-retailers-products-containing-small-powerful-magnets.html>.

¹¹ See <https://laws-lois.justice.gc.ca/eng/regulations/SOR-2011-17/page-3.html#h-1109670>.

¹² See <https://www.canada.ca/en/health-canada/services/consumer-product-safety/advisories-warnings-recalls/letters-notices-information-industry/information-manufacturers-importers-distributors-retailers-products-containing-small-powerful-magnets.html>.

¹³ See <https://laws-lois.justice.gc.ca/eng/acts/c-1.68/page-1.html>.

highlighted products intended for entertainment that consist of numerous small, powerful magnets.

Australia's Requirements Regarding Magnet Ingestion. Australia has also issued mandatory requirements for both children's toys, and non-children's products, to address the magnet ingestion hazard. For toys intended for children up to, and including, 36 months, Australia requires compliance with Australia New Zealand Standard AS/NZS ISO 8124.1, which aligns with the magnet requirements in ASTM F963.¹⁴

In addition, in November 2012, Australia adopted a permanent ban of consumer goods containing 2 or more separable or loose magnetic objects, where at least 2 of the magnetic objects each separately fit entirely within a small parts cylinder (specified in AS/NZS ISO 8124.1) and each have a flux index greater than 50 kG² mm² (using methods described in AS/NZS ISO 8124.1). The ban applies to magnetic objects marketed or supplied for use as a toy, game, puzzle, construction or modelling kit, or jewelry to be worn in or around the mouth or nose. This includes adult desk toys, educational toys or games, and toys, games, and puzzles for mental stimulation or stress relief.¹⁵

New Zealand's Requirements Regarding Magnet Ingestion. As indicated above, New Zealand also uses AS/NZS ISO 8124.1, which aligns with the magnet requirements in ASTM F963, to address the magnet ingestion hazard in children's toys.¹⁶

¹⁴ See <https://www.legislation.gov.au/Details/F2008C00607>.

¹⁵ See <https://www.legislation.gov.au/Details/F2012L02171>; <https://www.productsafety.gov.au/bans/small-high-powered-magnets>.

¹⁶ See <https://www.standards.govt.nz/shop/asnz-iso-8124-12019/>.

In addition, in January 2013, New Zealand issued a temporary ban¹⁷ on the sale of certain high-powered magnets, which it extended indefinitely in July 2014.¹⁸ The ban applies to magnetic objects for personal, domestic, or household use that are supplied, offered, or advertised as a toy, game, puzzle, novelty, construction or modelling kit, or jewelry that may be worn in or around the mouth or nose. This includes adult desk toys, educational toys and games, and toys, games, and puzzles for mental stimulation or stress relief. The ban does not apply to hardware magnets, magnets used for teaching purposes by schools and universities, or magnets intended to become part of another product. The ban applies to the specified products if they contain 2 or more separable or loose magnetic objects, at least 2 of the magnetic objects each separately fit entirely within a small parts cylinder (specified in AS/NZS ISO 8124.1), and at least 2 of those magnets have a flux index greater than 50 kG² mm² (using methods described in AS/NZS ISO 8124.1).

The European Commission's Requirements Regarding Magnet Ingestion. The European Commission requires children's toys to comply with EN 71-1, *Safety of Toys*, discussed further in section V. **Relevant Existing Standards**, below. The requirements in EN 71-1 relating to magnet ingestion are essentially the same as the requirements in ASTM F963-17. There is no safety standard regarding magnet ingestions for products other than children's toys. However, member states generally apply EN 71-1 when assessing the risk posed by products that are not marketed as children's toys, but are intended for children, including magnet sets intended for adults because they are often bought for and used by children.

¹⁷ See <https://www.beehive.govt.nz/release/ban-sale-high-powered-magnet-sets#:~:text=Consumer%20Affairs%20Minister%20Simon%20Bridges,stores%20and%20over%20the%20internet>.

¹⁸ Unsafe Goods (Small High Powered Magnets) Indefinite Prohibition Notice 2014, available at: <https://gazette.govt.nz/notice/id/2014-go4501>; see also, <https://productsafety.tradingstandards.govt.nz/for-business/regulated-products/small-high-powered-magnets-unsafe-goods-notice/>; <https://productsafety.tradingstandards.govt.nz/for-consumers/safety-with-specific-products/high-powered-magnets/>.

II. Statutory Authority

Subject magnet products are “consumer products” that the Commission has authority to regulate under the CPSA. *See* 15 U.S.C. 2052(a)(5). Section 7 of the CPSA authorizes the Commission to issue a mandatory consumer product safety standard that consists of performance requirements or requirements that the product be marked with, or accompanied by, warnings or instructions. *Id.* 2056(a). Any requirement in the standard must be “reasonably necessary to prevent or reduce an unreasonable risk of injury” associated with the product. *Id.* Section 7 requires the Commission to issue such a standard in accordance with section 9 of the CPSA. *Id.*

Section 9 of the CPSA specifies the procedure the Commission must follow to issue a consumer product safety standard under section 7. *Id.* 2058. Under section 9, the Commission may initiate rulemaking by issuing an advance notice of proposed rulemaking (ANPR) or NPR. *Id.* 2058(a). When issuing an NPR, the Commission must comply with section 553 of Administrative Procedure Act (5 U.S.C. 551-559), which requires the Commission to provide notice of a rule and the opportunity to submit written comments on it. 5 U.S.C. 553; 15 U.S.C. 2058(d)(2). In addition, the Commission must provide interested parties with an opportunity to make oral presentations of data, views, or arguments. *Id.* 2058(d)(2).

Under section 9 of the CPSA, an NPR must include the text of the proposed rule, any alternatives the Commission proposes, and a preliminary regulatory analysis. *Id.* 2058(c). The preliminary regulatory analysis must include:

- a preliminary description of the potential benefits and costs of the rule, including benefits and costs that cannot be quantified, and the analysis must identify who is likely to receive the benefits and bear the costs;

- a discussion of the reasons any standard or portion of a standard submitted to the Commission in response to an ANPR was not published by the Commission as the proposed rule or part of the proposed rule;
- a discussion of the reasons for the Commission’s preliminary determination that efforts submitted to the Commission in response to an ANPR to develop or modify a voluntary standard would not be likely, within a reasonable period of time, to result in a voluntary standard that would eliminate or adequately reduce the risk of injury addressed by the proposed rule; and
- a description of alternatives to the proposed rule that the Commission considered and a brief explanation of the reasons the alternatives were not chosen.

Id.

In addition, to issue a final rule, the Commission must make certain findings and include them in the rule. *Id.* 2058(f)(1), (f)(3). Under section 9(f)(1) of the CPSA, before promulgating a consumer product safety rule, the Commission must consider, and make appropriate findings to be included in the rule, concerning the following issues:

- the degree and nature of the risk of injury the rule is designed to eliminate or reduce;
- the approximate number of consumer products subject to the rule;
- the need of the public for the products subject to the rule and the probable effect the rule will have on the cost, availability, and utility of such products; and
- the means to achieve the objective of the rule while minimizing adverse effects on competition, manufacturing, and commercial practices.

Id. 2058(f)(1). Under section 9(f)(3) of the CPSA, the Commission may not issue a consumer product safety rule unless it makes the following findings and includes them in the rule:

- that the rule, including the effective date, is reasonably necessary to eliminate or reduce an unreasonable risk of injury associated with the product;
- that issuing the rule is in the public interest;
- if a voluntary standard addressing the risk of injury has been adopted and implemented, that either compliance with the voluntary standard is not likely to result in the elimination or adequate reduction of the risk of injury, or there is unlikely to be substantial compliance with the voluntary standard;
- that the benefits expected from the rule bear a reasonable relationship to its costs; and
- that the rule imposes the least burdensome requirement that prevents or adequately reduces the risk of injury.

Id. 2058(f)(3). At the NPR stage, the Commission is making these findings on a preliminary basis to allow the public to comment on them.

III. The Product and Market

A. Description of the Product

The proposed rule applies to “subject magnet products,” which are consumer products that are designed, marketed, or intended to be used for entertainment, jewelry (including children’s jewelry), mental stimulation, stress relief, or a combination of these purposes, and that contain one or more loose or separable magnets (subject magnet products). Toys that are subject to 16 CFR part 1250, *Safety Standard Mandating ASTM F963 for Toys*, are exempt from this proposed rule.

Subject magnet products include a wide variety of consumer products. Magnets in subject magnet products typically are small, powerful, magnetic balls, cubes, cylinders, and other shapes that can be used to create jewelry (such as necklaces, bracelets, and simulated piercings), and can

be aggregated to make sculptures, for use as desk toys, and as other building sets. One common example of a subject magnet product is magnet sets intended for users 14 years and older.

Consistent with the Commission's 2014 rule, magnet sets are aggregations of separable magnetic objects that are marketed or commonly used as a manipulative or construction items for entertainment, such as puzzle working, sculpture building, mental stimulation, or stress relief.

Magnet sets often contain hundreds to thousands of loose, small, high-powered magnets.

Another example of a subject magnet product is jewelry with separable magnets, such as jewelry-making sets and faux magnetic piercings/studs. Additional examples include products commonly referred to as "executive toys," "desk toys," and "rock magnets" (rock-shaped magnets), intended for amusement of users 14 years and older.

Subject magnet products are available in a variety of shapes (*e.g.*, balls, cubes, cylinders), sizes (*e.g.*, 2.5 mm, 3 mm, 5 mm), and number of magnets (*e.g.*, 1 to thousands). Subject magnet products often consist of numerous identical magnets, although some products include non-identical magnets, such as two or more different shapes. Subject magnet products commonly include magnets between 3 mm and 6 mm in size, and consist of several hundred magnets. One example of a common subject magnet product that staff identified is magnet sets containing approximately 200 magnetic spheres with 5 mm diameters.

Magnets in subject magnet products have a variety of compositions, such as alloys of neodymium, iron, boron (NIB); ferrite/hematite; aluminum, nickel, cobalt (AlNiCo); and samarium and cobalt (SmCo). NIB and SmCo magnets are often referred to as "rare earth" magnets because neodymium and samarium are "rare earth" elements found on the periodic table. Most subject magnet products that staff identified were made from NIB. NIB is typically used in smaller magnets used for magnet sets and magnetic jewelry sets, and ferrite/hematite is

typically used in larger magnets, such as rock-shaped magnet toys. The magnetized cores of subject magnet products are coated with a variety of metals and other materials to make them more attractive to consumers and to protect the brittle magnetic alloy materials from breaking, chipping, and corroding.

Staff found that 5 mm diameter NIB magnets (the most common size identified in magnet ingestion incidents) typically have strong magnetic properties, ranging between 300 and 400 $\text{kG}^2 \text{mm}^2$, and ferrite rock magnets measured upwards of 700 $\text{kG}^2 \text{mm}^2$. Staff also identified products close to the proposed limit of 50 $\text{kG}^2 \text{mm}^2$, ranging from approximately 30 $\text{kG}^2 \text{mm}^2$ to 70 $\text{kG}^2 \text{mm}^2$. Some subject magnet products advertise having flux indexes lower than 50 $\text{kG}^2 \text{mm}^2$, which is more common for smaller magnets (*e.g.*, 2.5 mm magnets).

Some subject magnet products are “children’s products.” The definition of “children’s products,” and the requirements applicable to them, are described in section **XII. Testing, Certification, and Notice of Requirements**, below. To summarize, a “children’s product” is a consumer product that is “designed or intended primarily for children 12 years of age or younger.” 15 U.S.C. 2052(a)(2). Most subject magnet products are not children’s products because the proposed rule excepts from the standard products that fall under the mandatory toy standard, which applies to playthings intended for users under 14 years old. However, some subject magnet products are children’s products because, although they are intended for users 12 years old and younger, they do not fall under the toy standard because they are not playthings. One example of a subject magnet product that could be a children’s product and not a toy is children’s jewelry.

B. The Market

Magnet products intended for the purposes covered in the proposed rule largely entered the market in 2008, with significant sales beginning in 2009. Of the various products covered by the proposed rule, magnet sets have been particularly concerning to CPSC, given their popularity, uses for amusement and jewelry, their involvement in ingestion incidents, and the large number of loose, small, high-powered magnets in the sets. For this reason, CPSC's previous efforts to address the magnet ingestion hazard largely have focused on magnet sets. Accordingly, much of the information staff has about the market for subject magnet products focuses on magnet sets,¹⁹ which are the largest category of identified products involved in magnet ingestions.

From 2009 through mid-2012, most magnet set sellers were retailers with physical stores, such as bookstores, gift shops, and other outlets. In contrast, nearly all current marketers (firms or individuals) of magnet sets sell through internet sites, rather than physical stores. Some of these internet sites are operated by importers, but most sellers (in terms of distinct firms or individuals, if not unit sales) sell through their stores operated on the sites of other internet retailer platforms.

In 2018, CPSC contracted with Industrial Economics, Incorporated (IEc) to examine the market for magnet sets. IEc found a total of 69 sellers of magnet sets on internet platforms in late 2018. IEc also identified 10 manufacturers and 2 retailers.²⁰ CPSC staff had previously identified at least 121 sellers of magnet sets on internet retailer platforms. However, IEc found that most sellers CPSC had previously identified were no longer selling relevant magnet set products,

¹⁹ Staff's analysis for the 2014 rule and 2020 informational briefing package focused on magnet sets.

²⁰ IEc classified manufacturers as firms producing and selling their own magnet set products, and retailers as firms that typically sell magnets from multiple manufacturers.

indicating a high turnover rate for magnet set products and sellers. In 2020, CPSC staff reviewed the status of previously identified sellers of magnet sets on leading internet marketplaces and found further evidence of the high turnover rates for these platforms. Only 9 of the 69 sellers IEc identified in late 2018 were still selling magnet sets; the remainder either no longer offered magnet sets, or no longer operated on the platforms. In addition, CPSC staff identified 29 new sellers that had not been identified in late 2018.

In both 2018 and 2020, staff found that many magnet-set sellers were located domestically, or in China or Hong Kong. In 2018, approximately 57 percent of magnet set sellers on one internet platform fulfilled orders domestically, whereas, in 2020, this declined to 25 percent. In 2018, approximately 25 percent of magnet set sellers on another internet platform were domestic, whereas, in 2020, this increased to 87 percent. Non-domestic sellers were primarily in China and Hong Kong. In addition to internet retailers based in the United States, consumers can also purchase a wide variety of magnet sets using online retailers based in China. Magnet sets purchased from foreign internet retailers may be shipped to consumers directly from China, or from warehouse facilities located domestically.

Retail prices of subject magnet products are about \$20 per unit, on average. Magnet sets comprised of spheres or cubes with smaller dimensions (2.5 mm to 3 mm) typically retail at lower prices.

As indicated above, CPSC staff primarily has information about magnet sets, however, additional products are also subject to the proposed rule. CPSC staff is aware of magnets marketed online as jewelry, jewelry-making sets, and faux studs/piercings, as well as entertainment products, such as “desk toys” and “executive toys.” CPSC requests comments

about unit sales and other market information about subject magnet products, particularly for products other than magnet sets.

IV. Risk of Injury

CPSC staff analyzed reported fatalities, reported nonfatal incidents and injuries, and calculated national estimates of injuries treated in U.S. hospital emergency departments (EDs) that were associated with ingestion of subject magnet products. Staff also assessed the health outcomes associated with these incidents, as well as various characteristics of the incidents.

A. Incident Data²¹

To evaluate magnet ingestion incidents, staff reviewed reports in the National Electronic Injury Surveillance System²² (NEISS), which includes reports of injuries treated in U.S. EDs, and reports in the Consumer Product Safety Risk Management System²³ (CPSRMS). The data presented here represent the minimum number of incidents during the periods described.

1. National Estimates of ED-Treated Injuries

To evaluate magnet ingestion incidents in NEISS, staff started by identifying magnet ingestion cases in the NEISS database with treatment dates from January 1, 2010 through December 31, 2020. Staff then excluded from this data set incidents that staff could not determine involved magnets (*e.g.*, “acc swallowed dog toy vs magnet”); incidents that did not involve ingestion, or where it was uncertain whether ingestion occurred (*e.g.*, “possible ingestion,” “may have ingested”); and incidents that provided ambiguous information about

²¹ For more details about incident data, see Tab B and Tab C of the NPR briefing package.

²² Data from NEISS are based on a nationally representative probability sample of about 100 hospitals in the United States and its territories. NEISS data can be accessed from the CPSC website under the “Access NEISS” link at: <https://www.cpsc.gov/Research--Statistics/NEISS-Injury-Data>.

²³ CPSRMS is the epidemiological database that houses all anecdotal reports of incidents CPSC receives, “external cause”-based death certificates purchased by CPSC, all in-depth investigations of these anecdotal reports, as well as investigations of select NEISS injuries. Examples of documents in CPSRMS include: hotline reports, Internet reports, news reports, medical examiner reports, death certificates, retailer/manufacturer reports, and documents sent by state/local authorities, among others.

whether the item ingested was a magnet (*e.g.*, the report refers to a magnet and ingestion, but it is not clear that the magnet was the object ingested). This may have resulted in underestimating the number of incidents.

From the remaining data set, staff categorized incidents by magnet type. Based on the products identified in NEISS reports, or the description of the products, staff organized cases into the following categories: magnet sets, magnet toys, jewelry, science kits, home/kitchen, ASTM F963 magnet toys, and unidentified. The criteria staff used to categorize incidents into these groups are as follows:

- **Magnet Sets:** Magnets from sets of loose, as-received magnets that are marketed or commonly used as a manipulative or construction item for entertainment, such as puzzle working, sculpture building, mental stimulation, or stress relief. These items met at least one of the following criteria: referred to as a magnet set or identified as a magnet set through product name. This category excludes building sets with plastic and/or ferromagnetic components, unless otherwise identified as a magnet set. This category also excludes products reasonably identified as belonging to another product type described below (*e.g.*, a magnetic clasp from a necklace).
- **Magnet Toys:** Magnets from products referred to as toys or games. This category includes products for which the manufacturer-intended user of the toy was 14 years or older, or was unknown, and it excludes cases that positively identified toys subject to ASTM F963 (*i.e.*, excludes products confirmed to have been designed, manufactured, or marketed as playthings for children under 14 years of age).

- Jewelry: Magnets described as jewelry (*i.e.*, magnets that are jewelry, or that were being used as or like jewelry) and not definitively identified as a magnet set. Most of these cases involve magnets described as a bracelet, necklace, or piercing jewelry.
- Science Kits: Magnets from products identified as a science kit or magnetic/electrical experimental set.
- Home/Kitchen: Magnets from products such as non-toy magnet decorations, shower curtains, hardware, and kitchen products. Many of these incidents refer to the magnets as “kitchen magnets.”
- ASTM F963 Magnet Toys: Magnets from toys subject to ASTM F963 (*i.e.*, products designed, manufactured, or marketed as playthings for children under 14 years old). Reports for these incidents included brand names or other information sufficient for staff to identify the involved products as toys subject to ASTM F963. Most of these cases involved the magnetic tip of a children’s magnetic stylus toy.
- Unidentified: Unidentified magnet product type.

As the descriptions above indicate, “magnet toys” and “ASTM F963 magnet toys” refer to two different types of products. “Magnet toys,” as used throughout this preamble, refers to products described as toys, but that did not include indications that the product was marketed for users under 14 years old. In contrast, “ASTM F963 magnet toys” refers to products that staff identified as toys marketed for children under 14 years old; as such, these products are subject to ASTM F963, and they do not fall under the scope of the proposed rule.

With respect to the science kit category, staff identified only one case that involved a product described as a science kit. There was insufficient information about the product to determine whether it was a children’s toy subject to ASTM F963, an educational product, or a

subject magnet product. Because of this lack of information, and the possibility that it was a children’s toy or educational product, staff considered this case outside the scope of the proposed rule.

Staff considered the following categories to be subject magnet products: magnet sets, magnet toys, and jewelry; these are referred to collectively as “amusement/jewelry.” These categories include incidents in which the report identified a subject magnet product as being ingested, or the incident report provided information about the product, such as characteristics or use patterns, that were sufficient for staff to reasonably conclude that the product fell in a certain product type category. Staff considered cases in the following categories to be outside the scope of the proposed rule: science kits, home/kitchen, and ASTM F963 magnet toys; these are referred to collectively as “exclusions.” Incidents in the unidentified category did not provide sufficient information to identify the magnet product category, however, they did indicate that a magnet was ingested, and the product had characteristics and use patterns that could be consistent with subject magnet products. Section *IV.A.5. Uncertainties in Incident Data*, below, explains several reasons why staff concludes that a substantial portion of unidentified product type incidents involved subject magnet products.

Table 1 provides the number of cases in each product type category, and the combined categories reported by NEISS participating hospitals.

Table 1: Count of Magnet Ingestion Cases Treated in NEISS Hospital EDs, by Magnet Category, 2010-2020

Original Magnet Category	N (Original)	Combined Magnet Category	N (Combined)
Magnet Set	58	Amusement/Jewelry	221
Jewelry	53		
Magnet Toy	110		
Unidentified	793	Unidentified	793
Science Kit	1	Exclusions	58
F963 magnet toy	11		
Home/Kitchen	46		
Total	1,072	Total	1,072

Source: NEISS, CPSC.

As Table 1 indicates, of the incidents for which staff could identify a product type category, most incidents involved magnet toys, followed by magnet sets, and jewelry. For 74 percent of incidents, staff could not identify the product type category.

Using the information from the sample of NEISS participating hospitals, staff derived estimates of the number of magnet ingestions treated in U.S. hospitals nationally from 2010 through 2020. For staff to generate national estimates using NEISS data, all of the following reporting criteria must be met: the coefficient of variation (CV) cannot exceed 0.33, there must be at least 20 sample cases, and there must be at least 1,200 estimated injuries. Because of the large portion of NEISS incidents in the unidentified product type category, to meet these criteria, it was necessary to combine the amusement/jewelry and unidentified categories to generate national estimates, and it was not possible to generate national estimates for individual product categories. Thus, the national estimates provided in the rest of this section include incidents in both the amusement/jewelry and unidentified categories of NEISS data. Although the national estimates include magnet ingestion cases in the unidentified product type category, there are several reasons why staff concludes that most magnet ingestion incidents in the unidentified product type category involved subject magnet products, including incident data about known

product types, trend data, and recall data. Section *IV.A.5. Uncertainties in Incident Data*, below, discusses, in detail, the reasons staff concludes that most unidentified product type incidents involved subject magnet products.

Table 2 provides the estimated number of ED-treated magnet ingestions for the combined categories.

Table 2: Estimated Number of Magnet Ingestions Treated in U.S. Hospital EDs, by Magnet Category, 2010-2020

Magnet Category	Estimate	CV	N
Amusement/Jewelry	4,400	0.17	221
Unidentified	18,100	0.14	793
Exclusions	1,300	0.20	58
Total	23,700	0.21	1,072

Source: NEISS, CPSC. Estimates rounded to the nearest 100. Summations of estimates may not add to the total estimates, due to rounding.

Table 3 provides the national estimates of ED-treated magnet ingestions, by year.

Table 3: Estimated Number of Magnet Ingestions Treated in U.S. Hospital EDs, by Year

Year	Estimate	CV	N
2010	1,900	0.18	91
2011	2,500	0.18	101
2012	2,700	0.26	115
2013	2,000	0.21	88
2014	**	**	62
2015	1,200	0.24	61
2016	1,400	0.24	77
2017	2,900	0.25	112
2018	2,400	0.18	120
2019	1,800	0.22	91
2020	2,200	0.21	96
Total	22,500	0.14	1,014

**This estimate does not meet NEISS reporting criteria.

Source: NEISS, CPSC. Estimates rounded to the nearest 100. Summations of estimates may not add to the total estimates, due to rounding.

There were significantly fewer ED-treated magnet ingestions in 2015 than in any of the following years: 2010, 2011, 2012, 2017, and 2018. Likewise, there were significantly fewer ED-treated magnet ingestions in 2016 than in any of the following years: 2011, 2017, and 2018.

Overall, 2014 through 2016 had the lowest number of estimated ED-treated magnet ingestions. Table 4 compares these middle 3 years (*i.e.*, 2014-2016) with the earliest 4 years (*i.e.*, 2010-2013), and the most recent 4 years (*i.e.*, 2017-2020). Because these periods are not of equivalent duration, staff estimated annual averages to support fair comparisons.

Table 4: Estimated Number of Magnet Ingestions Treated in U.S. Hospital EDs, by Period

Period	Annual Average Estimate	CV	N (not an average)	Years in Period
2010 - 2013	2,300	0.16	395	4
2014 - 2016	1,300	0.20	200	3
2017 - 2020	2,300	0.15	419	4
2010 - 2020	2,000	0.14	1,014	11

Source: NEISS, CPSC. Estimates are rounded to the nearest 100. Summations of estimates may not add to the total estimates, due to rounding.

Table 5 provides estimated ED-treated magnet ingestions, by age group.

Table 5: Estimated Number of Magnet Ingestions Treated in U.S. Hospital EDs, by Age Group, 2010-2020

Age Group	Estimate	CV	N
Under 2 years	2,700	0.19	120
2 years	2,300	0.27	89
3-4 years	4,700	0.16	196
5-7 years	4,300	0.14	207
8-10 years	3,900	0.19	179
11-13 years	3,400	0.17	182
14 or More years	**	**	41
Total	22,500	0.14	1,014

**This estimate does not meet NEISS reporting criteria.

Source: NEISS, CPSC. Estimates are rounded to the nearest 100. Summations of estimates may not add to the total estimates, due to rounding.

Table 6 provides the estimated number of ED-treated magnet ingestions, by sex.

Table 6: Estimated Number of Magnet Ingestions Treated in U.S. Hospital EDs, by Sex, 2010-2020

Sex	Estimate	CV	N
Female	9,100	0.15	421
Male	13,300	0.14	593
Total	22,500	0.14	1,014

Source: NEISS, CPSC. Estimates are rounded to the nearest 100.

Table 7 provides the estimated number of ED-treated magnet ingestions, by sex and age group. Staff used 8 years old to delineate older and younger children because, as discussed in section V. **Relevant Existing Standards**, several voluntary standards provide less stringent requirements for magnet products intended for users 8 years and older.

Table 7: Estimated Number of Magnet Ingestions Treated in U.S. Hospital EDs, by Sex and Age Group, 2010-2020

Sex	Age Group		Total
	Under 8 Years	8 or More Years	
Female	5,600	3,500	9,100
Male	8,400	4,900	13,300
Total	14,000	8,500	22,500

Source: NEISS, CPSC. Estimates are rounded to the nearest 100. Summations of estimates may not add to the total estimates, due to rounding.

Table 8 provides the estimated number of ED-treated magnet ingestions, by disposition.

Table 8: Estimated Number of Magnet Ingestions Treated in U.S. Hospital EDs, by Disposition, 2010-2020

Disposition	Estimate	CV	N
Hospitalized/Transferred	4,200	0.19	264
Treated and Released	18,000	0.14	735
Other *	**	**	15
Total	22,500	0.14	1,014

*Dispositions in the “other” category include cases in which the victim was “held for observation (includes admitted for observation)” and “left without being seen/left against medical advice.”

**This estimate does not meet reporting criteria.

Source: NEISS, CPSC. Estimates are rounded to the nearest 100. Summations of estimates may not add to the total estimates, due to rounding.

As Table 8 indicates, approximately 80 percent of estimated ED-treated magnet ingestions are treated and released, and approximately 19 percent are hospitalized or treated and

transferred to another hospital. Some portion of cases that report the victim being treated and released may have resulted in later hospitalization because magnet ingestion patients are often sent home initially to monitor for natural passage, and the NEISS data typically capture only one part of the treatment process—the ED visit—and do not typically provide information about treatment after the initial ED visit.

2. Reported Incidents

CPSC staff also reviewed CPSRMS data for magnet ingestion incidents. CPSRMS reports commonly contain more information about the incident, product, and victims than NEISS reports because CPSRMS reports may provide photos and websites with detailed narratives and medical documents, whereas, NEISS reports contain only brief narratives from the ED visit. However, CPSRMS data do not provide a complete count of all incidents that occurred during a period, and unlike NEISS data, CPSRMS cannot be used for statistical estimates or to draw conclusions about trends. Rather, CPSRMS data provide a minimum number of incidents that occurred during a period and provide details about incidents.

CPSC staff identified 284 magnet ingestion incidents in CPSRMS that were reported to have occurred between January 1, 2010 and December 31, 2020. Data collection is ongoing for CPSRMS, and is considered incomplete for 2019 and after, so CPSC may receive additional reports for those years in the future. Staff categorized these cases similarly to the NEISS incidents, however, there are some minor differences in the criteria because CPSRMS reports typically contained more product-specific information than NEISS reports. Based on the products identified in the CPSRMS reports or the descriptions of the products, staff organized cases into the following categories: magnet sets, magnet toys, jewelry, science kits,

home/kitchen, ASTM F963 magnet toys, and unidentified. The criteria staff used to categorize incidents into these groups are as follows:

- Magnet Sets: Magnets from sets of loose, as-received magnets that are marketed or commonly used as a manipulative or construction item for entertainment, such as puzzle working, sculpture building, mental stimulation, or stress relief. These items met at least one of the following criteria:
 - referred to as a magnet set;
 - identified as a magnet set through product name;
 - included photos identifying the product; or
 - other available information provided reasonable certainty that the product was a magnet set (*e.g.*, products described identically to known magnet sets, such as desk toys consisting of 216 loose, magnetic balls).

Brand was indicated for most of these incidents. Incidents were excluded from this grouping if a medical professional identified the product as a magnet set, but the investigator and victim indicated that they were unable to identify the product as a magnet set.

- Magnet Toys: Magnets from products referred to as toys or games. This category includes products for which the manufacturer-intended user of the toy was 14 years or older, or was unknown, and excludes cases that positively identified toys subject to ASTM F963 (*i.e.*, excludes products confirmed to have been designed, manufactured, or marketed as playthings for children under 14 years of age).

- Jewelry: Magnets described as jewelry and not definitively identified as a magnet set. Most of these cases involve magnets described as a bracelet, necklace, or piercing jewelry.
- Science Kits: Magnets from products identified as a science kit or magnetic/electrical experimental set. (No reported incidents fit in this category.)
- Home/Kitchen: Magnets from products such as non-toy magnet decorations, shower curtains, hardware, and kitchen products.
- ASTM F963 Magnet Toys: Magnets from toys subject to ASTM F963 (*i.e.*, products designed, manufactured, or marketed as playthings for children under 14 years old). Reports for these incidents included brand names or other information sufficient for staff to identify the products involved as toys subject to ASTM F963. Most of these cases involved magnetic building sets with magnets encased in plastic.
- Unidentified: Unidentified magnet product type.

Like NEISS product type categories, “magnet toys” and “ASTM F963 magnet toys” refer to two different types of products. Staff categorized as “magnet toys” products described as toys, which did not have evidence of having been marketed for users under 14 years old. In contrast, “ASTM F963 magnet toys” are toys staff identified as marketed for children under 14 years old, making them subject to ASTM F963, and outside the scope of the proposed rule.

Consistent with the NEISS data analysis, staff considered the following categories to be subject magnet products: magnet sets, magnet toys, and jewelry; these are referred to collectively as “amusement/jewelry.” These categories include incidents in which the report identified a subject magnet product as being ingested, or the incident report provided information about the product, such as characteristics or use patterns, which were sufficient for staff to reasonably

conclude that the product fell in a certain product type category. Staff considered incidents in the following categories to be outside the scope of the proposed rule: science kits, home/kitchen, and ASTM F963 magnet toys; these are referred to collectively as “exclusions.” Incidents in the unidentified category did not provide sufficient information to identify the magnet product category, however, they did indicate that a magnet was ingested, and the product had characteristics and use patterns that could be consistent with subject magnet products. As with the NEISS cases, staff concludes that a substantial proportion of the unidentified category involved subject magnet products (see section *IV.A.5. Uncertainties in Incident Data*, below).

Table 9 provides the number of reported magnet ingestions in each category.

Table 9: Reported Magnet Ingestions, by Magnet Category, 2010-2020

Magnet Category	Incidents	Proportion	Scope	Incidents	Proportion
Magnet Set	134	47.2%	Amusement/ Jewelry	214	75.4%
Magnet toy	49	17.3%			
Jewelry	31	10.9%			
Unidentified	43	15.1%	Unidentified	43	15.1%
Science Kit	0	0%	Exclusions	27	9.5%
F963 Magnet Toy	21	7.4%			
Home/Kitchen	6	2.1%			
Total	284	100.0%	Total	284	100.0%

Note: CPSRMS reporting for 2019-2020 is ongoing.

As Table 9 shows, of the incidents for which staff could identify a product type category, most involved magnet sets, followed by magnet toys, and jewelry. Fewer cases involved products that are not subject magnet products (*i.e.*, science kits, ASTM F963 magnet toys, and home/kitchen). Compared to NEISS data, far fewer incidents involved unidentified product types.

To further analyze CPSRMS data, staff combined the following categories—magnet sets, magnet toys, jewelry, and unidentified. Staff included the unidentified product type category in this analysis because, as noted for NEISS data, there are several reasons that staff concludes that most magnet ingestion incidents in the unidentified product type category involved subject magnet products, including incident data about known product types, trend data, and recall data. Section *IV.A.5. Uncertainties in Incident Data*, below, discusses, in detail, the reasons staff concludes that most unidentified product type incidents involved subject magnet products. Thus, the data provided in the rest of this section includes incidents in both the amusement/jewelry and unidentified categories of CPSRMS data.

Figure 1 shows the reported CPSRMS magnet ingestion incidents, by year of incident and product type category.

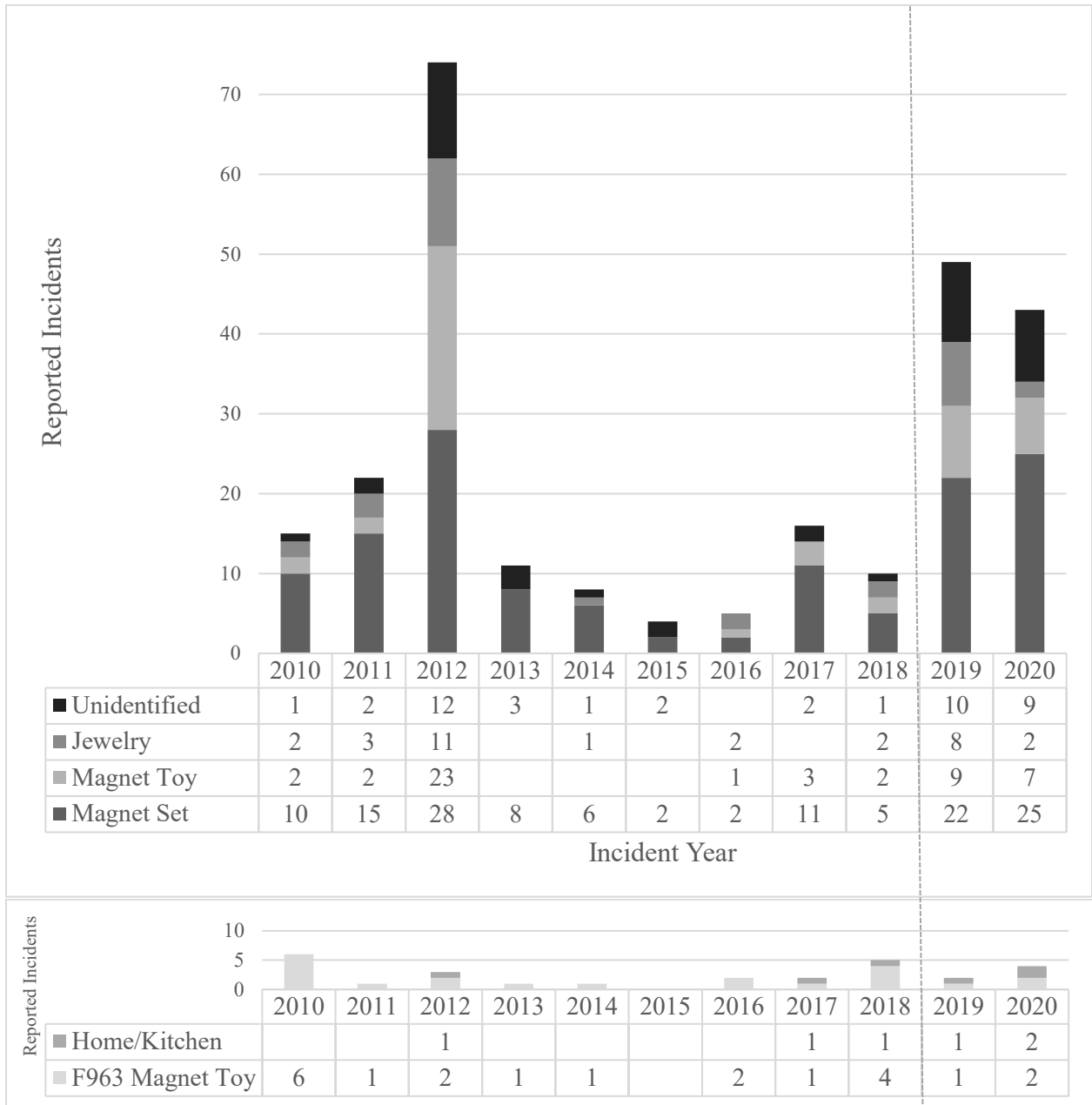

Note: CPSRMS reporting for 2019-2020 is ongoing.

Figure 1: Histogram of Reported Magnet Ingestion Incidents, by Incident Year and Magnet Category, 2010-2020

Although CPSRMS data cannot be used to draw statistical conclusions, this data suggests that magnet ingestion incidents increased in 2012, 2019, and 2020, and were lowest in 2015 and 2016, consistent with the results seen in the NEISS data.

Figure 2 shows reported magnet ingestions, by victim age and product type category.

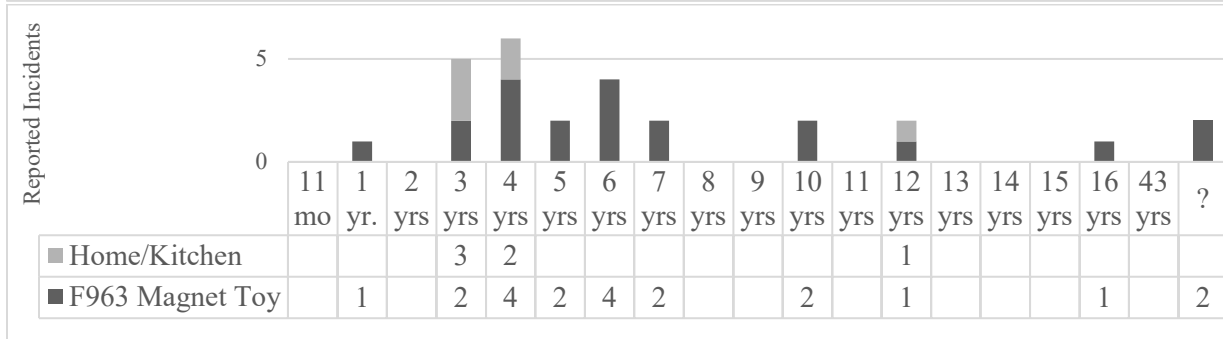
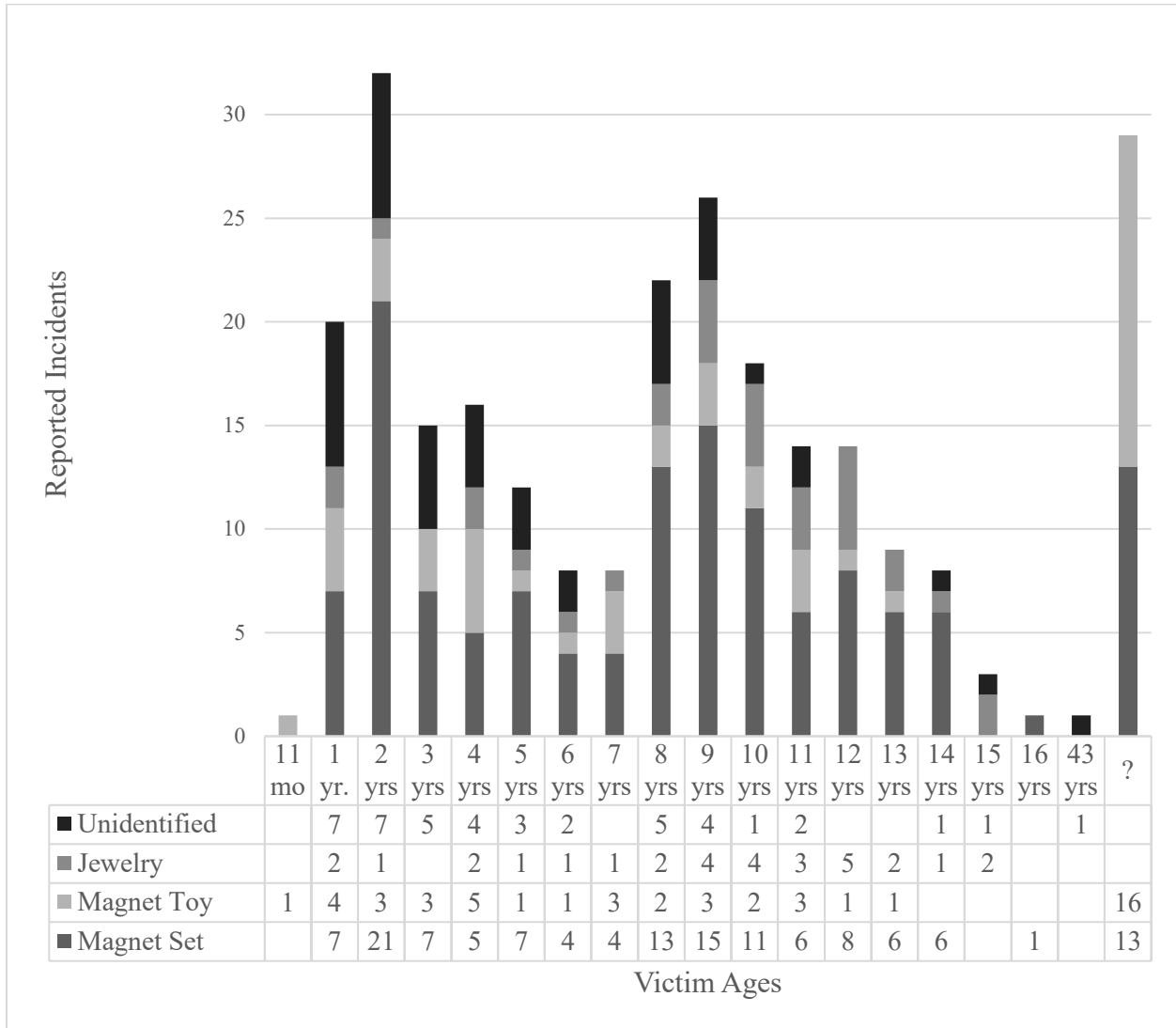

Note: CPSRMS reporting for 2019-2020 is ongoing. Incidents for which the victim’s age is unknown are indicated under “?” and are not graphed. For one victim in the “15 yrs” category, the report included conflicting information, and the victim may have been 16 years old.

Figure 2: Histogram of Reported Magnet Ingestion Incidents, by Victim Age and Magnet Category, 2010-2020

Again, although CPSRMS data cannot be used to draw statistical conclusions, the data suggest that children and teens of all ages ingest magnets, and similar to the NEISS data, most magnet ingestions involve children 5 years or older, with almost half of the ingestions involving children 8 years or older.

Table 10 provides the disposition of reported magnet ingestion cases, by product type category.

Table 10: Reported Magnet Ingestion Incidents, by Disposition and Magnet Category, 2010- 2020

Magnet Category	Disposition			Total
	Death	Hospitalization	Other	
Magnet Sets	-	88	46	134
Magnet Toys	-	36	13	49
Jewelry	-	21	10	31
Unidentified	3 ²⁴	27	13	43
ASTM F963 Magnet Toys	-	10	11	21
Home/Kitchen	-	5	1	6
Total	3	187	94	284

Note: CPSRMS reporting for 2019-2020 is ongoing.

As Table 10 indicates, of the 284 ingestions reported to have occurred between January 1, 2010 and December 31, 2020, the vast majority resulted in hospitalization, and three resulted in death. The remaining “other” dispositions include all remaining reported incidents that did not report either hospitalization or death.

In analyzing CPSRMS magnet ingestion incidents, CPSC staff identified at least 124 cases that resulted in some form of surgery, including laparoscopy, laparotomy, appendectomy, cecostomy, enterotomy, colostomy, cecectomy, gastrotomy, jejunostomy, resection, and transplant. Numerous additional cases resulted in less-invasive procedures than surgery, such as

²⁴ As discussed below, staff identified a total of 7 deaths resulting from magnet ingestions between November 24, 2005 and January 5, 2021. The 3 deaths reflected here include only the fatalities that occurred in the United States between January 1, 2010 and December 31, 2020.

endoscopies and colonoscopies, and could have resulted in surgery if the magnets had not been retrieved soon after ingestion. In 108 cases, the reports specifically described the magnets internally attracting through bodily tissue, and for other cases, there was insufficient information to determine if the surgeries were a result of the magnetic properties.

3. *Fatalities*

The CPSRMS data above indicate that staff identified three fatal magnet ingestion incidents that were reported to have occurred during the period staff used for incident data analysis—January 1, 2010 and December 31, 2020. However, in total, CPSC is aware of seven deaths involving the ingestion of hazardous magnets between November 24, 2005 and January 5, 2021.²⁵ Five of these deaths occurred in the United States. In 2005, a 20-month-old child’s death involved ingestion of magnets from a children’s toy building set with plastic-encased magnets; the product was later recalled. In 2013, a 19-month-old child’s death involved multicolored, 5 mm diameter, spherical magnets from an unidentified product. In 2018, a 2-year-old child’s death involved multicolored, 3-5 mm diameter, spherical magnets, with indications that the product likely was a magnet set. In 2020, a 43-year-old man’s death involved magnets from an unknown product. In 2021, a 15-month-old-child’s death involved a magnet set of an unknown brand. In addition, CPSC is aware of two deaths in other countries that involved ingestion of hazardous 5 mm diameter, spherical NIB magnets. In Australia in 2011, an 18-month-old child’s death involved a product that included indications that it may have been a magnet set; and in Poland in 2014, an 8-year-old child’s death involved a product that appeared likely to be a magnet set. One of these seven incidents involved a children’s amusement product; one

²⁵ The additional deaths are not included in Table 10 because they occurred outside the timeframe of staff’s data analysis or outside the United States.

explicitly identified the product as a magnet set; and another four incidents described the products as having characteristics consistent with magnet sets.

4. *Incident Data Surrounding the Vacated Magnet Sets Rule*

In looking at annual magnet ingestion incidents, staff noted a considerable change in magnet ingestion rates before, during, and after the Commission's vacated rule on magnet sets. As discussed above, the Commission issued a final rule in October 2014 that applied to magnet sets, which are a subset of the subject magnet products addressed in this proposed rule. The magnet sets rule aimed to address the magnet ingestion hazard and consisted of size and strength limits consistent with the requirements in this proposed rule. The magnet sets rule took effect in April 2015 and remained in effect until it was vacated by the U.S. Court of Appeals for the Tenth Circuit Court in November 2016. CPSC's assessment of incident data, as well as other researchers' assessments of NEISS data, and national poison center data, indicate that magnet ingestion cases significantly declined during the years in which the magnet sets rule was announced and in effect, compared to the periods before and after the rule.

As Table 3,²⁶ above, shows, the number of estimated ED-treated magnet ingestion incidents was significantly lower in 2015—when the magnet sets rule was in effect—than in the years before the rule was announced (specifically, 2010, 2011, 2012) and the years after the rule was vacated (specifically, 2017 and 2018). Similarly, the number of estimated ED-treated magnet ingestion incidents was significantly lower in 2016—when the rule was in effect—than before the rule was announced (specifically, 2011) and the years after the rule was vacated (specifically, 2017 and 2018).²⁷

²⁶ Table 3 provides national estimates of magnet ingestions per year for incidents categorized as amusement/jewelry and unidentified product types.

²⁷ Statistically significant differences are not reported for the year 2014, because the corresponding estimate does not meet reporting criteria.

To assess these trends further, staff grouped years in relation to the vacated magnet sets rule, using the following periods: 2010 through 2013 (prior to the announcement of the rule), 2014 through 2016 (when the final rule was announced and in effect²⁸), and 2017 through 2020 (after the rule was vacated). Table 4, above, shows the estimated number of magnet ingestions treated in U.S. hospital EDs during these periods, using annual estimates for each period to account for the periods including different numbers of years (*i.e.*, 2014-2016 covers 3 years, whereas, 2010-2013 and 2017-2020 cover 4-year periods). For 2010-2013 and 2017-2020, there were an estimated 2,300 ED-treated magnet ingestion incidents per year; for 2014-2016, there were an estimated 1,300 ED-treated magnet ingestion incidents per year. Thus, during the period when the rule was announced and in effect (2014-2016), there were appreciably fewer magnet ingestions compared with the earlier and more recent periods, and there were nearly equivalent rates during the periods both before and after the rule.

Although CPSRMS data cannot be used to draw statistical conclusions, the data also suggest a similar decline in incidents for the period when the magnet sets rule was announced and in effect. Table 11 shows CPSRMS-reported magnet ingestions, by period, using incidents categorized as amusement/jewelry and unidentified product types, consistent with the NEISS analysis, above.

²⁸ Staff grouped 2014, 2015, and 2016 together for this analysis because these are the years firms were likely to comply with the size and strength limits in the magnet sets rule. Because the standard took effect in April 2015 and remained in effect until November 2016, firms were required to comply with the standard for nearly all of 2015 and 2016. Although the rule was not in effect in 2014, the proposed rule was published in 2012, and the final rule was published, with essentially the same requirements, in October 2014. Once an NPR is published, firms have notice to prepare for the requirements that may be finalized, and once a final rule is published, firms often take steps to comply with the rule even before it takes effect. Accordingly, it is reasonable to conclude that firms took steps to comply with the magnet sets standard in 2014.

Table 11: Number of CPSRMS-Reported Magnet Ingestions, by Period

Period	Percent of total	N	Years in period
2010 - 2013	47.5%	122	4
2014 - 2016	6.6%	17	3
2017 - 2020	45.9%	118	4
2010 - 2020	100%	257	11

Source: CPSRMS. Percentages are rounded to the nearest tenth. CPSRMS reporting for the years 2019-2020 is ongoing and counts for those years may increase as reporting continues.

Consistent with NEISS trends shown in Table 3, Table 11 shows that CPSRMS data also reflect an appreciable decline in magnet ingestion incidents during the period when the magnet sets rule was announced and in effect (2014-2016), compared with earlier and more recent periods, and nearly equivalent incident rates during the periods both before and after the rule.

Other researchers analyzing NEISS data made similar findings. One study²⁹ reviewed magnet ingestions for children under 18 years old using NEISS data from 2009 through 2019, focusing on three periods: 2009 through 2012 (before the Commission rule on magnet sets); 2013³⁰ through 2016 (magnet sets rule announced and in effect); and 2017 through 2019 (after the rule was vacated). In 2009-2012, there was an aggregate mean ED-visit rate of 3.58³¹ per 100,000 people; in 2013-2016, this decreased to 2.83³² per 100,000 people³³; and in 2017-2019, this increased to 5.16³⁴ per 100,000 people.³⁵ Like CPSC's analysis, this illustrates an

²⁹ Flaherty, M.R., Buchmiller, T., Vangel, M., Lee, L.K. Pediatric Magnet Ingestions After Federal Rule Changes, 2009-2019. *JAMA*. Nov. 24, 2020. 324(20): 2102–2104. doi:10.1001/jama.2020.19153, available at: <https://www.ncbi.nlm.nih.gov/pmc/articles/PMC7686864/>.

³⁰ For CPSC's analysis, staff considered 2014 to be the year the rule was announced because that is the year the final rule was published. In contrast, this study considered 2013 to be the year the rule was announced, likely because that is the first full year after the rule was initially announced in an NPR in September 2012.

³¹ 95% confidence interval (CI), 2.20–4.96.

³² 95% CI, 1.60–4.06.

³³ Slope change, 0.87 (95% CI, 0.71–1.03) ED visits per 100,000 annually.

³⁴ 95% CI, 3.22–7.11.

³⁵ Slope change, –0.58 (95% CI, –0.68 to –0.47) per 100,000 persons annually.

appreciable decline in magnet ingestions during the period the magnet sets rule was announced and in effect, with an even greater increase in incidents after the rule than before it.

Another study³⁶ found similar results when looking at suspected magnet ingestion (SMI) cases involving children under 18 years old using NEISS data. That study found that there were an estimated 23,756³⁷ total SMI cases between 2009 and 2019, of which an estimated 3,709³⁸ cases involved small/round magnets and 6,100³⁹ involved multiple magnets. The average annual increase in total cases was 6.1 percent for 2009 to 2019,⁴⁰ and there was a statistically significant increase in small/round magnet ingestions⁴¹ and multiple magnet ingestions⁴² between 2009 and 2019. When stratified by period, there were 6,391⁴³ estimated total magnet ingestion cases during 2013-2016,⁴⁴ or 1,598⁴⁵ estimated cases per year. In contrast, there were an estimated 8,478⁴⁶ cases from 2017-2019, or 2,826⁴⁷ per year. This represents a 32 percent increase⁴⁸ in total magnet ingestions after 2016. There was also a statistically significant increase in the number of estimated small/round⁴⁹ and multiple magnet⁵⁰ ingestions across these two periods,

³⁶ Reeves, P.T., Rudolph, B., Nylund, C.M. Magnet Ingestions in Children Presenting to Emergency Departments in the United States 2009-2019: A Problem in Flux. *Journal of Pediatric Gastroenterology and Nutrition*. Dec. 2020. 71(6):699-703, 10.1097/MPG.0000000000002955, available through: <https://pubmed.ncbi.nlm.nih.gov/32969961/>.

³⁷ CI, 15,878–30,635.

³⁸ CI, 2,342–5,076.

³⁹ CI, 3,889–8,311.

⁴⁰ P=0.01.

⁴¹ P<0.001.

⁴² P=0.02.

⁴³ CI, 4,181–8,601.

⁴⁴ Like the previous study, these researchers considered 2013 to be part of the period during which magnet sets were likely to be off the market.

⁴⁵ CI, 1,045–2,150.

⁴⁶ CI, 5,472–11,485.

⁴⁷ CI, 1,824–3,828.

⁴⁸ P<0.001.

⁴⁹ P<0.01.

⁵⁰ P<0.001.

with 164⁵¹ small/round and 350⁵² multiple magnet ingestions from 2013 through 2016, compared to 541⁵³ small/round and 797⁵⁴ multiple magnet ingestion cases from 2017 through 2019.

Researchers⁵⁵ analyzing national poison center data also found an increase in magnet ingestions in recent years, particularly since the magnet sets rule was vacated. This study looked at magnet foreign body injuries in pediatric patients in the National Poison Data System (NPDS). For 2012-2017, there were 281 magnet exposure calls per year, compared to 1,249 calls per year for 2018-2019, representing a 444 percent increase. Considering cases dating back to 2008 (5,738 total), the cases from 2018 and 2019, alone, account for 39 percent of the magnet cases. Although these periods do not directly align with the magnet sets rule, they further illustrate the general increase in magnet ingestion incidents in recent years, particularly after the magnet sets rule was vacated.

These analyses raise relevant considerations for this proposed rule. For one, the marked decline in incidents during the period when the magnet sets rule was announced and in effect suggests that a large portion of magnet ingestion incidents involve magnet sets. Because that rule applied only to magnet sets, the fact that incidents significantly declined during the pendency of that rule indicates that magnet sets were involved in most of the incidents. This is useful information, given the lack of details regarding product types involved in many magnet ingestion incidents. In addition, these analyses indicate the current need to address the magnet ingestion hazard. Magnet ingestion incidents have significantly increased in recent years, showing a heightened need to address the hazard. Finally, these analyses suggest that a mandatory standard

⁵¹ CI, 66–263.

⁵² CI, 200–500.

⁵³ CI, 261–822.

⁵⁴ CI, 442–1152.

⁵⁵ Middelberg, L.K., Funk, A.R., Hays, H.L., McKenzie, L.B., Rudolph, B., Spiller, H.A. Magnet Injuries in Children: An Analysis of the National Poison Data System From 2008-2019. *The Journal of Pediatrics*. May 1, 2021. Volume 232, P251-256.E2, available at: doi: <https://doi.org/10.1016/j.jpeds.2021.01.052>.

is necessary to effectively reduce the risk of injuries and death associated with magnet ingestions. Before, during, and after the magnet sets rule, CPSC and other groups have worked to raise awareness of the magnet ingestion hazard, and CPSC has taken steps to address the hazard through information campaigns, recalls, and voluntary standards work. However, the only appreciable decline in magnet ingestion incidents occurred during the period when the mandatory standard for magnet sets was announced and in effect.

5. *Uncertainties in Incident Data*

As explained above, magnet ingestion incident reports often include limited information for staff to identify the type of product involved in the magnet ingestion. Caregivers and medical providers may know that a magnet was ingested, but may not know from what type of product the magnet came. This differs from many consumer products that are readily identifiable when involved in an incident and report. NEISS data, in particular, tend to provide limited information with which to identify the product involved in magnet ingestions. This may be because NEISS data are collected through hospital EDs. At hospital EDs, medical professionals may not know what product was the source of the magnet ingestion, and are focused on information needed to treat the victim (*e.g.*, that a magnet was ingested), rather than the specific product involved in the incident (*e.g.*, that the magnet came from a magnet set). Because CPSRMS data usually come from manufacturers and consumers, these data often contain more information to identify the product.

As Table 1, above, shows, of the 1,072 magnet ingestion incidents identified in NEISS, 74 percent (793 incidents) did not provide sufficient information for staff to identify the type of product involved. As Table 9, above, shows, of the 284 magnet ingestion incidents identified in CPSRMS, 15 percent (43 incidents) did not provide sufficient information for staff to identify

the type of product involved. However, staff does have some information about the incidents in the unidentified product type category—specifically, these incidents involved ingestion of one or more magnets, and included product characteristics and use patterns that could be consistent with subject magnet products.

To account for the lack of product identification in many magnet ingestion incidents, staff analyzed magnet ingestion incident data in several ways. For one, staff provided information about all magnet ingestion cases. Aggregated information for all of the in-scope, out-of-scope, and unidentified product categories indicates that magnet ingestions, in general, are an issue, and have increased in recent years. This indicates the propensity for children and teens to ingest magnets, and it demonstrates the increasing risk of injury and death as magnet ingestion cases increase.

Staff also categorized incidents into specific product groups, based on information that was available in incident reports. For incidents that provided information to help identify the product type, the data revealed that six categories of products were involved in magnet ingestions—magnet sets, jewelry, magnet toys, science kits, ASTM F963 magnet toys, and home/kitchen magnets. For some of the incidents in these categories, there was specific information about the product—such as brand names—that allowed staff to determine the product involved in the incident. For other incidents in these categories, the product was referred to as a specific type (*e.g.*, magnet sets, desk toy, science kit, kitchen magnet, bracelet).⁵⁶ These

⁵⁶ Staff categorized incidents based on all of the information available in the reports, including descriptions, names, and uses of the product. However, for some of the incidents in which the report provided a product type, but not a specific product brand/name, it is possible that the product was actually from another category. For example, the jewelry category includes cases in which the report indicates that the magnets were described as jewelry at the time of the incident, such as magnetic earrings. It is possible that the magnets in such cases were actually from a non-jewelry product. Similarly, products categorized as magnet toys could actually be another product type; for example, a product described as an “executive desk toy,” which did not meet the parameters for the magnet set category, and did not indicate marketing to children under 14 years old, was included in the magnet toy group, although it is

categories provide information about the products involved in magnet ingestions, and the relative frequency of their involvement, to help determine which products the proposed rule should address.

Staff also aggregated these categories into in-scope and out-of-scope groupings. Staff combined incidents from the magnets sets, magnet toys, and jewelry categories as “amusement/jewelry” and combined incidents from the home/kitchen, ASTM F963 magnet toys, and science kit categories as “exclusions.” Grouping several product type categories together allowed staff to generate national estimates of ED-treated magnet ingestions, to provide an idea of the number of ingestions nationally, and the relative involvement of in-scope and out-of-scope products, which helps identify the magnitude of the risk and the potential benefits of the rule to reduce that risk.

In addition, staff combined the amusement/jewelry and unidentified categories to conduct more detailed analyses. Because the proposed rule applies to amusement and jewelry products, the amusement/jewelry category of incidents is informative. Staff also included in these analyses, incidents in the unidentified product type category because there are several factors that indicate that many of the incidents in the unidentified product type category likely fall within the scope of the proposed rule. The following is a discussion of these factors.

First, the incident data discussed in this preamble supports the conclusion that many of the magnet ingestion incidents in the unidentified product type category actually involved subject magnet products. Of the NEISS magnet ingestion incidents for which staff could identify a product category, the primary products involved were magnet sets, magnet toys, and jewelry; far

possible that the product actually was a magnet set or other product type, and the report lacked information to indicate this. However, even if incidents in these categories were miscategorized, they likely would still fall within the scope of the proposed rule because they meet the description of an in-scope product.

fewer incidents involved ASTM F963 magnet toys, home/kitchen magnets, or science kits (see Table 1, above). The same was true for CPSRMS incidents (see Table 9, above), for which far fewer incidents were in the “unidentified” category. Given this consistency across data sets, it is reasonable to conclude that the relative involvement of magnet product types in magnet ingestions applied to the incidents that lacked product identification as well.

Second, magnet ingestion rates before, during, and after the vacated rule on magnet sets suggest that a significant portion of magnet ingestion cases involve magnet sets. As discussed above, CPSC’s assessment of incident data, as well as other researchers’ assessments of NEISS data, and national poison center data, indicate that magnet ingestion cases significantly declined during the years the magnet sets rule was announced and in effect, compared to the periods before and after the rule. Magnet sets were the only products subject to that rule. As such, the significant decline in incidents during that rule, and the significant increase in incidents after that rule was vacated, strongly suggest that many magnet ingestion incidents involve magnet sets. Thus, it is reasonable to assume that many of the incidents in the unidentified product category involved magnet sets. Moreover, the definition of “magnet sets” in the vacated rule was largely equivalent to the description of amusement products in the present proposed rule (*i.e.*, magnet sets and magnet toys), suggesting that many magnet ingestion incidents, including those with unidentified product types, involve amusement products.

Third, incident data and recalls regarding magnets in children’s toys further support the conclusion that magnet ingestions categorized as “unidentified” products are largely subject magnet products. As discussed above, ASTM F963 magnet toys make up only a small portion of magnet ingestion incidents where the product can be identified. It is reasonable to assume that this holds true for unidentified products in magnet ingestions, as well. Recall information further

supports this conclusion. Recalls of children's toys involving the magnet ingestion hazard have declined substantially since the toy standard took effect. As explained above, ASTM F963 was announced as the mandatory standard for toys in 2008, and it took effect in 2009. From 2006 through 2009, CPSC issued more than a dozen recalls of children's toys, due to the ingestion hazard associated with loose or separable, small, powerful magnets.⁵⁷ In contrast, from January 2010 through August 2021—a period approximately three times as long—there were a total of 18 recalls related to the magnet ingestion hazard, only four of which involved children's toys. Of those four recalls, only two involved confirmed violations of the magnet provisions in the toy standard. Recalls provide some indication of the products involved in magnet ingestions because products are recalled when they present a hazard. Thus, this marked decline in recalls of children's toys for magnet ingestion hazards suggests that children's toys largely comply with the toy standard and are not involved in hazardous incidents.

Taken together, these factors support the conclusion that most magnet ingestion incidents, including those in the unidentified product type category, involved products that fall within the magnet sets, magnet toys, and jewelry categories, and not the science kit, home/kitchen, or ASTM F963 magnet toys categories. For these reasons, staff included magnet ingestion incidents in the unidentified product type category in many of its analyses; to exclude such incidents likely would vastly underrepresent ingestions of subject magnet products.

⁵⁷ https://www.cpsc.gov/s3fs-public/pdfs/recall/lawsuits/abc/163--2017-10-26%20Final%20Decision%20and%20Order.pdf?Tme8u5fRF2.29_B.i4Ix7pPwb_whKng2.

*B. Details Concerning Health Outcomes*⁵⁸

Magnets are unique among ingested foreign bodies because of their intrinsic ability to attract to one another or to ferromagnetic objects. Assuming the same elemental composition, a magnet with large physical dimensions and mass can exhibit stronger attractive forces than a magnet with small physical dimensions and mass. Similarly, magnets coupled together can exhibit greater attractive strengths than individual magnets. One mechanism of injury following magnet ingestion involves separate magnets in adjacent tissue walls (*e.g.*, from distinct loops of bowel) attracting to each other and trapping tissue between the magnets. The mechanism of injury is the same for a single hazardous magnet and a ferromagnetic object that might interact internally. As such, individual magnets pose the same health risk.

Health threats posed by magnet ingestion include pressure necrosis, volvulus, bowel obstruction, bleeding, fistulae, ischemia, inflammation, perforation, peritonitis, sepsis, ileus, ulceration, aspiration, and death, among others. The normal functions of the gastrointestinal (GI) tract, including peristalsis, are not likely to dislodge magnets that are attracted to each other through component tissues.

The time between magnet ingestion and injury varies and depends on several factors, such as the number of ingested magnets; awareness of the magnet ingestion by caregivers; awareness that magnet ingestion is hazardous; whether multiple ingested magnets interact with each other inside of the body through tissue structures; and the configuration of coupled

⁵⁸ For more details about injuries and health outcomes, see Tab A of the NPR briefing package. In addition, health outcomes associated with magnet ingestions are discussed in the Final Rule briefing package for the 2014 rule on magnet sets, available at: https://www.cpsc.gov/s3fs-public/pdfs/foia_SafetyStandardforMagnetSets-FinalRule.pdf, and the 2020 informational briefing package, available at: <https://www.cpsc.gov/s3fs-public/Informational%20Briefing%20Package%20Regarding%20Magnet%20Sets.pdf>. Even though the previous analyses focused on magnet sets, the internal magnet interaction hazard is the same for the subject magnet products covered in this proposed rule.

magnets, relative to involved tissue structures. Incident reports describe injuries from internal magnet interaction through tissue taking anywhere from days to months to progress to a stage at which caregivers seek medical attention. There have been several efforts to develop medical devices using magnets to deliberately compress and necrose⁵⁹ target tissue and create healthy anastomoses (openings/passages) that connect or reconnect distinct channels in the body. In these controlled cases, tissue necrosis typically took multiple days to weeks.⁶⁰

Ambiguous symptomatology following magnet ingestion that results in an internal interaction injury may complicate the timely delivery of medical care. Symptoms related to magnet ingestion may appear flu-like and include vomiting, fever, and abdominal pain, among others. Symptoms following magnet ingestion have been mistaken for a virus, ear infection, and bronchitis, among others. Medical professionals who know of the magnet ingestion may be able to minimize or avoid injury by promptly removing the magnets.

Internal Magnet Interaction Injuries. As indicated above, one of the health threats presented by magnet ingestion is internal magnet interaction leading to pressure necrosis injuries that occur in the alimentary canal. Necrosis is a process of cell death, secondary to injury, which undermines cell membrane integrity and involves intricate cell signaling responses. In the case of internal magnet interactions, the injury leading to necrosis is the pressure on the involved biological tissues that exceeds local capillary pressure and leads to ischemia.

Volvulus is another internal interaction hazard associated with magnet ingestion.

Volvulus is an obstructive twisting of the GI tract. Volvulus is often accompanied by abdominal

⁵⁹ Necrosis is a process of cell death.

⁶⁰ These efforts are still in early stages, but may ultimately provide some examples of the time it takes for tissue necrosis to occur from magnetic compression. Although not pathological examples, the length of time required for successful anastomoses in preclinical medical device development settings ranged from multiple days to weeks, as evaluated by necropsy and passage of the magnet after anastomosis formation. In a human trial, magnets passed naturally multiple weeks after placement to create healthy anastomoses.

pain, distended abdomen, vomiting, constipation, and bloody stools. If left untreated, volvulus may lead to bowel ischemia, perforation, peritonitis, and death. Volvulus following magnet ingestion has been linked to fatal outcomes. In the United States, CPSC is aware of one death of a 20-month-old child who ingested magnets from a toy construction set, which caused volvulus, and one death of a 2-year-old child who ingested multiple magnets, resulting in small intestine ischemia secondary to volvulus. In addition, CPSC is aware of one death of an 8-year-old child in Poland, due to small intestine ischemia secondary to volvulus, after the victim ingested magnets that resulted in necrosis, toxemia (blood poisoning), hypovolemic shock, and eventually cardiopulmonary failure.

Like outcomes related to volvulus, small bowel ischemia can lead to local tissue necrosis, perforation, and subsequent peritonitis. Small intestine ischemia was implicated in the death of a 19-month-old child following ingestion of multiple magnets. Bowel obstruction, often a consequence of volvulus, is associated with abdominal cramps, vomiting, constipation, and distention. With respect to the relationships among local capillary and intraluminal pressures and magnet ingestions, subsequent outcomes include possible blockage of local blood and nutrient supply; progressive pressure necrosis of the involved tissues; and local inflammation, ulceration, and tissue death, with putative outcomes such as perforation (hole) or fistula in the GI tract. If left untreated, or otherwise unnoticed, such events can progress into infection, sepsis, and death. The obstruction from the trapped tissue can elicit vomiting, and the local mucosa irritation may stimulate diarrhea. Advancing pressure necrosis of the involved tissues can lead to necrosis and subsequent leakage of the bowel contents into the peritoneal cavity.

Another example of the potential health outcomes associated with magnet ingestion is a case in which an asymptomatic 4-year-old child sustained several fistulae in the intestines that

required surgical repair after ingesting magnets. Fistulae are abnormal passages between channels in the body that are associated with increased mortality. Fistulae may enable the leakage of gut contents into adjacent tissue structures or abdominal cavities, which can lead to infection, inflammation, perforation, sepsis, and possibly death. Fistulae may also bypass portions of the GI tract, thus undermining normal GI function.

Another potential health outcome of magnet ingestions is ulcerations. For example, one case involved a 28-month-old child who experienced stomach ulcerations after ingesting 10 magnets and receiving treatment with medication after the endoscopic removal and natural passage of the magnets. Untreated ulcers may require surgical intervention if they progress to perforation, and a perforated bowel may lead to leakage from the GI tract. Several magnet ingestion incident reports highlight the threat of perforation with possible outcomes such as peritonitis. Peritonitis is an inflammation of the peritoneum, a membrane lining of the abdominal cavity, which may be associated with leakage from the GI tract that can lead to sepsis. Sepsis is the body's response to severe infection, and it is associated with elevated rates of morbidity and mortality that can be mitigated with prompt treatment. Treatment of abdominal sepsis may require repair of a leaky GI tract.

Another potential health risk from ingested magnets is an aspiration threat. For example, in one reported case, a 3-year-old child ingested multiple magnets, two of which were found attracting to each other on opposing surfaces of the pharyngoepiglottic fold in the throat, presenting an immediate aspiration threat given the proximity to the airway. Aspiration of magnets has also been reported elsewhere in medical literature. Foreign body aspiration presents a risk of airway obstruction, ventilatory difficulty, choking, hypoxic-ischemic brain injury, pulmonary hemorrhage, and death, among other health outcomes.

Other Health Outcomes and Injuries. In addition to internal interaction hazards, ingested magnets present additional health risks. Ingested magnets that are not attracting to each other through tissue walls may cause harm, such as irritation of the GI mucosa in the form of erythematous, mucosal inflammation, and minor tears. Ingested magnets embedded in the bowel may be associated with multiple days of hospitalization. A foreign body lodged in the GI tract can also cause mucosal wall deterioration, migration, and perforation. Comorbidities, such as eosinophilic esophagitis, gastroesophageal reflux disease, GI anomalies, and neuromuscular disorders can exacerbate the potential outcomes. The wall of the esophagus is susceptible to edema and weakening that increase the risk of bleeding and perforation in the presence of foreign bodies. Foreign body irritation of the GI tract may also prompt local mucosal irritation that can stimulate diarrhea.

Medical Care for Magnet Ingestions. Several approaches to medical care are available when assessing and treating magnet ingestions, however, many of these approaches pose health risks, themselves. Medical providers routinely use medical imaging during treatment of magnet ingestions. Current imaging diagnostic capabilities may be able to identify ingested foreign bodies, but they do not allow for the definitive identification of magnets in the body. The usefulness of metal detectors to locate ingested metallic objects, including magnets, has decreased as the size of ingested magnets decreases. This presents challenges when a caregiver and medical professional do not know the victim ingested a magnet.

When ingested magnets are identified, x-ray radiography, fluoroscopy, computed tomography (CT) scans, or ultrasound⁶¹ can be used to monitor the ingested magnets. If the

⁶¹ These imaging tools present some health risks themselves. The ionizing radiation associated with x-ray radiography has the potential to damage DNA and may contribute to the development of cancer later in life. The risks from CT scans are similar. Prolonged fluoroscopy, which is often used during surgery or medical procedures

magnets' passage through the GI tract is arrested or symptoms manifest, then endoscopic or surgical intervention may be necessary. Bowel cleanout or bowel preparation procedures that use laxatives,⁶² such as polyethylene glycol, may be used to try to flush ingested magnets out of the GI tract, or to prepare patients for endoscopy or other medical procedures.

Endoscopy may be used to retrieve ingested magnets from the stomach, duodenum, esophagus, pylorus and cecum (via colonoscopy), or other areas. Endoscopy may also be used to treat bowel obstruction secondary to magnet ingestion. Endoscopy is associated with a risk of bleeding from mucosal shearing or tearing that is elevated in the presence of anemia. There is also risk of adverse cardiopulmonary events (*e.g.*, oxygen desaturation, aspiration, respiratory arrest, shock, myocardial infarction) as a result of sedation and anesthesia; perforation from procedure instruments; infection from contaminated equipment, or from a perturbed endogenous source; and procedural risks largely associated with comorbidities (*e.g.*, cardiac disease, diabetes).

Colonoscopy is a common endoscopic procedure performed via the anus and shares many of the same risks as endoscopy. Laryngoscopy—a medical procedure to evaluate the upper aerodigestive tract—is used to investigate suspected magnets lodged in the throat. Associated risks of laryngoscopy include esophageal perforation, airway compromise, bleeding, dysphagia, and fever, among others. Nasal endoscopy may be useful to treat magnets embedded in the nose. Nasal endoscopy is associated with risks of mucosal irritation, minor hemorrhage, and overt hemorrhage.

such as endoscopy, may contribute to the development of cataracts, skin reddening, or hair loss. Ultrasound is relatively safe, but it may heat tissue or produce pockets of gas in body fluids or tissues.

⁶² Bowel cleanout is not often associated with risk in the pediatric population; dehydration is the most common adverse event that occurs. However, in certain instances, bowel cleanout laxatives may be delivered via nasogastric tube; there are rare reports of life-threatening aspiration of laxative solutions delivered via nasogastric tubes, especially in older populations with certain comorbidities.

Surgical interventions may be necessary to treat magnet ingestions when less invasive procedures, such as endoscopy or bowel cleanout, are clinically inappropriate or unsuccessful. In one example, in which a 5-year-old child ingested magnets, endoscopy failed to retrieve all of the magnets, and the remaining magnets were recovered via laparotomy with appendectomy. Abdominal surgeries, such as laparotomy (abdominal incision) and laparoscopy (fiber-optic visualization of the viscera via abdominal incision), that involve abdominal incisions and manipulation of abdominal organs are associated with the risk of adhesions that can cause pain, bowel obstructions that may require additional surgical intervention, female infertility, and bowel injury. For example, 6 months after a 2-year-old child underwent enterotomy and gastrostomy to remove 26 magnets from her jejunum and stomach, the child developed bowel adhesions that caused obstructions and required treatment with surgical adhesiolysis to cut the adhesions. Possible complications associated with laparotomy include pneumonia, cardiac complications, surgical site infection, wound dehiscence (rupture), urinary tract infection, respiratory tract infection, venous thromboembolism, kidney failure, heart and GI tract complications, septicemia, and death. Emergency laparotomies may be more prone to complications than elective laparotomies. For example, a 6-year-old child who ingested 20 magnets underwent a 20-day hospital stay to treat surgical wound infections following exploratory laparotomy with small bowel resection and appendectomy to retrieve the magnets.

Appendectomy may also result from magnet ingestions, and is commonly achieved via laparotomy or laparoscopy. Pain, wound infections, and intra-abdominal abscesses are possible following both laparoscopic and open appendectomies. Laparotomy may be accompanied by incisions of the stomach (gastrotomy) or intestines (enterotomy) to retrieve ingested magnets. Complications from surgical enterotomies, or incisions into the intestine, may be similar to those

of inadvertent enterotomies, which can occur during anastomosis procedures and include leakage, intra-abdominal abscesses, and death.

Surgical resection of the bowel may be performed to remove necrotic portions of the bowel, secondary to magnet ingestion. Small bowel resection is associated with risks of infection, fistulae, peritonitis, abscess, sepsis, and wound dehiscence secondary to leaky anastomoses. There is also the possibility of impairment to the intrinsic nutrient absorption functions of the bowel, depending on the resection location. End-to-end surgical anastomoses used to restore bowel continuity following resection are associated with the risk of leakage, intra-abdominal abscess, and death.

Complications associated with surgery to treat magnet ingestion have also included pancreatitis and additional hospitalization, additional surgery to treat incisional hernia, and the need for a lifelong feeding tube, among others. Endotracheal general anesthesia may be required for surgical treatments of magnet ingestion. Possible complications associated with general anesthesia include nausea, vomiting, sore throat, dental damage, myocardial ischemia or infarction, heart failure, cardiac arrest, arrhythmia, atelectasis (lung collapse), aspiration, bronchospasm, neurological effects, and renal effects, among others.

In addition to the medical procedures necessary to treat magnet ingestions, and the risks associated with those procedures, ingested magnets present unique challenges for medical professionals. For example, technical precision is reduced, and technical difficulty increases when ingested magnets attract to the metallic instruments used to retrieve them. In one example case, ingested magnets in the throat of a 3-year-old child suddenly attracted to the optic graspers inserted to retrieve the foreign bodies.

*C. Incident Characteristics*⁶³

Staff conducted a detailed analysis of incident data to identify hazard patterns and characteristics associated with magnet ingestion incidents, and staff also considered developmental and behavioral factors relevant to the hazard. These considerations helped inform the scope of products that need to be addressed in the proposed rule and the types of requirements that would be effective at reducing the magnet ingestion hazard.

1. Victim Age

Table 12 provides the ages of victims involved in magnet ingestion incidents, from both the NEISS and CPSRMS data sets. The table includes incidents in the magnet sets, magnet toys, and jewelry categories, as well as incidents in the unidentified product type category.⁶⁴

Table 12: Magnet Ingestion Incidents, by Age

Victim Age	NEISS (#)	NEISS (%)	CPSRMS (#)	CPSRMS (%)
< 2 yrs	120	11.8%	21	8.2%
2 yrs	89	8.8%	32	12.5%
3 yrs thru 4 yrs	196	19.3%	31	12.1%
5 yrs thru 7 yrs	207	20.4%	28	10.9%
8 yrs thru 10 yrs	179	17.7%	66	25.7%
11 yrs thru 13 yrs	182	18%	37	14.4%
14 yrs thru 16 yrs	30	3%	12	4.7%
> 16 yrs	11	1.1%	1	0.4%
Unknown	0	0%	29	11.3%
Totals:	1,014		257	

Source: NEISS, CPSRMS. Percentages are rounded to the nearest tenth.

The youngest victim for which an age was reported was 6 months old; the oldest age reported was 54 years old. Approximately 20 percent of the NEISS incidents and CPSRMS incidents involved victims under 3 years old. This is consistent with developmental and behavioral factors—typically, foreign body ingestions peak for children between 6 months and 3

⁶³ For additional information about hazard patterns and incident characteristics, see Tab C of the NPR briefing package.

⁶⁴ As explained above, several factors indicate that many of the incidents in the unidentified product type category likely involved subject magnet products, and these incidents indicate the age of children and teens involved in magnet ingestion incidents, generally. The table excludes out-of-scope products (*i.e.*, home/kitchen and ASTM F963 magnet toys).

years old, and 2-year-old children generally are mobile and unlikely to be supervised directly at all times. Children of these ages are commonly cited in reports involving ingestion of inedible objects, given their likelihood of orally exploring their environment and their limited ability to comprehend hazards. For these and other reasons, toys with small parts must have a choking hazard warning for children under 3 years old.⁶⁵

As Table 12 indicates, approximately 60 percent of NEISS incidents and 56 percent of CPSRMS incidents involved victims 5 years old and older. This age group is important because one option CPSC and voluntary standards groups have considered to address the magnet ingestion hazard is child-resistant (CR) packaging, which is packaging that is designed or constructed to be significantly difficult for children under 5 years old to open.⁶⁶ Because the majority of incidents involve victims who would not be protected by CR packaging, these data suggest that CR packaging would be unlikely to adequately reduce the magnet ingestion hazard.

Table 12 also shows that approximately 40 percent of NEISS incidents and 45 percent of CPSRMS incidents involved victims 8 years old and older. This is noteworthy because several voluntary standards exempt magnet products intended for users 8 years and older from size and strength requirements, instead requiring only warnings on such products. These standards seemingly assume that users 8 years old and older are less likely to ingest magnets or are able to understand and heed warnings about the magnet ingestion hazard better than younger children. However, the frequency of incidents involving users 8 years and older suggests that this is not the case.

⁶⁵ 16 CFR part 1501.

⁶⁶ See 16 CFR part 1700, issued under the Poison Prevention Packaging Act of 1970, 15 U.S.C. 1471-1477.

As indicated above, Table 12 includes incidents in the magnet sets, magnet toys, jewelry, and unidentified product categories, indicating that these incidents did not involve products that are intended for children under 14 years old.⁶⁷ Despite this, most magnet ingestion incidents involved children under 14 years old, indicating that subject magnet products appeal to and are accessible to children and teens. This demonstrates that a standard for children's toys, alone, is not sufficient to address the magnet ingestion hazard. Subject magnet products appeal to children and teens for various reasons. Magnets, particularly smooth magnets, have tactile appeal for fidgeting, stress relief, and other amusement. Some magnets capture attention because they are shiny, colorful, or both. They make soft snapping/clicking sounds when manipulated, which children and teens may find appealing. The magnets have properties of novelty, which arouse curiosity; incongruity, which tends to surprise and amuse; and complexity, which tends to challenge and maintain interest. Their strong magnetic properties cause them to behave in unexpected ways, with pieces suddenly snapping together, and moving apart. Such behavior is likely to seem magical to younger children, and evoke a degree of awe and amusement among older children and teens.

2. *Use Patterns*

In reviewing incident data, staff identified the following patterns in how the magnets were being used at the time of ingestion:

- **Playing**—These cases involved ingestion of magnets while users were playing, fidgeting, orally exploring the magnets (*e.g.*, testing the attraction through teeth or on braces), or performing a combination of these actions. If playing involved use of the product as

⁶⁷ As discussed above, incidents in the unidentified product category likely involve subject magnet products, and not ASTM F963 magnet toys.

jewelry, the case was categorized as jewelry, rather than playing. This category excludes cases involving intentional ingestion.

- Jewelry—These cases involved magnets victims were using as jewelry at the time of the incident, such as bracelets, necklaces, and simulated piercings (*e.g.*, magnets used around the tongue, lip, and cheek to look like piercings).
- Intentionally ate—In these cases, victims reportedly swallowed magnets on purpose (*e.g.*, curiosity, mistaking the magnets as edible).
- Other—These cases involved identified actions that did not fit the categories above (*e.g.*, transporting magnets orally, magnets thrown into a victim’s mouth when not playing, and magnets placed in a victim’s drink).
- Unknown—In these cases, it was unclear what led to the magnet ingestion.

Table 13 provides the use patterns involved in magnet ingestion incidents, from both the NEISS and CPSRMS data sets. The table includes incidents in the magnet sets, magnet toys, and jewelry categories, as well as incidents in the unidentified product type category.⁶⁸

Table 13: Magnet Ingestion Incidents, by Use Pattern

Use Category	NEISS (#)	NEISS (%)	CPSRMS (#)	CPSRMS (%)
Playing	143	14.1%	61	23.7%
Jewelry	31	3.1%	43	16.7%
Intentionally Ate	19	1.9%	21	8.2%
Other	10	1%	4	1.6%
Unknown	811	80%	128	49.8%
Totals:	1014		257	

Source: NEISS, CPSRMS. The percentages are rounded to the nearest tenth.

As Table 13 shows, in both data sets, for incidents in which the use pattern could be identified, magnets were commonly used as playthings at the time of ingestion, followed by magnets used as jewelry. This supports the need to address amusement and jewelry products in the proposed

⁶⁸ As explained above, several factors indicate that many of the incidents in the unidentified product type category likely involved subject magnet products, and these incidents indicate the use patterns involved in magnet ingestion incidents, generally. The table excludes out-of-scope products (*i.e.*, home/kitchen and ASTM F963 magnet toys).

rule. In addition, these data indicate that the use pattern is unknown for many magnet ingestions, suggesting that victims are too young to report the use pattern and ingest magnets while outside caregiver supervision.

Figure 3⁶⁹ shows the use patterns during magnet ingestion incidents, by victim age, for the NEISS data set. Figure 4⁷⁰ shows the use patterns during magnet ingestion incidents, by victim age, for the CPSRMS data set. Both figures include incidents in the magnet sets, magnet toys, and jewelry categories, as well as incidents in the unidentified product type category.⁷¹

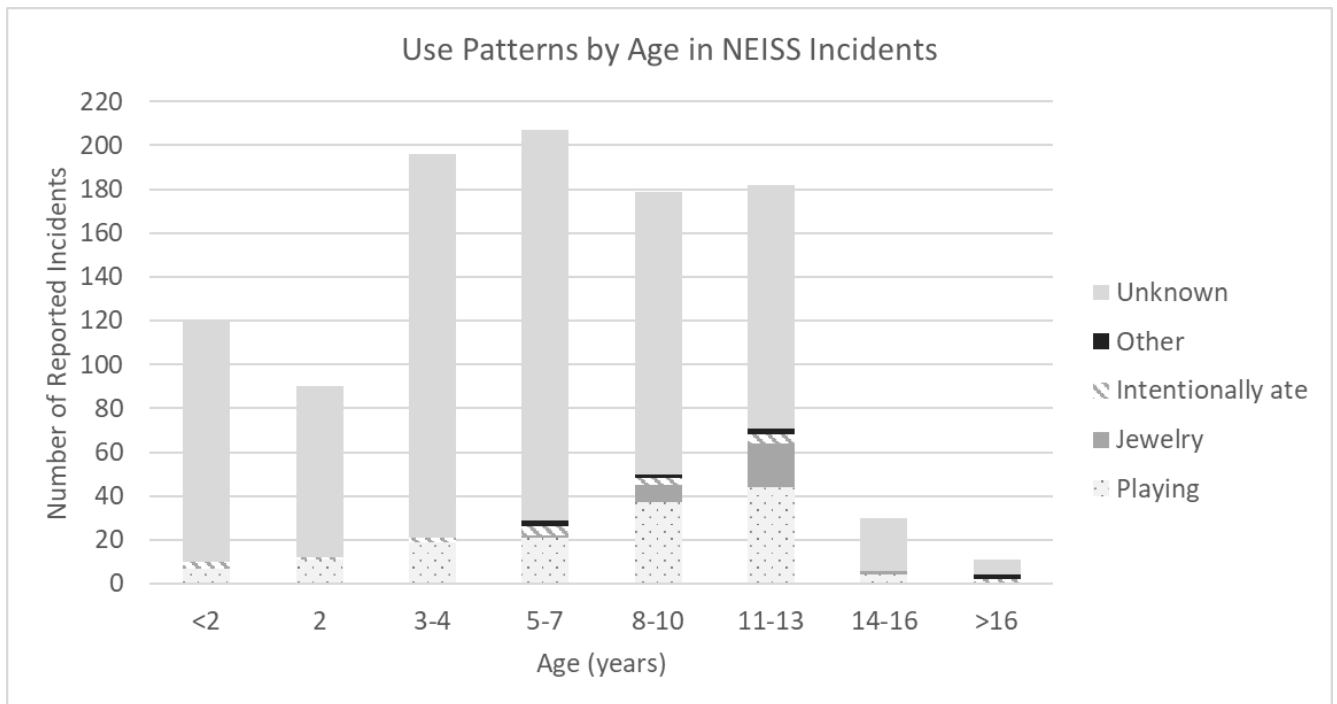

Figure 3: Magnet ingestion incidents, by use pattern and victim age, for NEISS incidents.

⁶⁹ To see Figure 3 in color, see Figure 2 in Tab C of the NPR briefing package.

⁷⁰ To see Figure 4 in color, see Figure 3 in Tab C of the NPR briefing package.

⁷¹ As explained above, several factors indicate that many of the incidents in the unidentified product type category likely involved subject magnet products, and these incidents indicate the use patterns and ages involved in magnet ingestion incidents, generally. The table excludes out-of-scope products (*i.e.*, home/kitchen and ASTM F963 magnet toys).

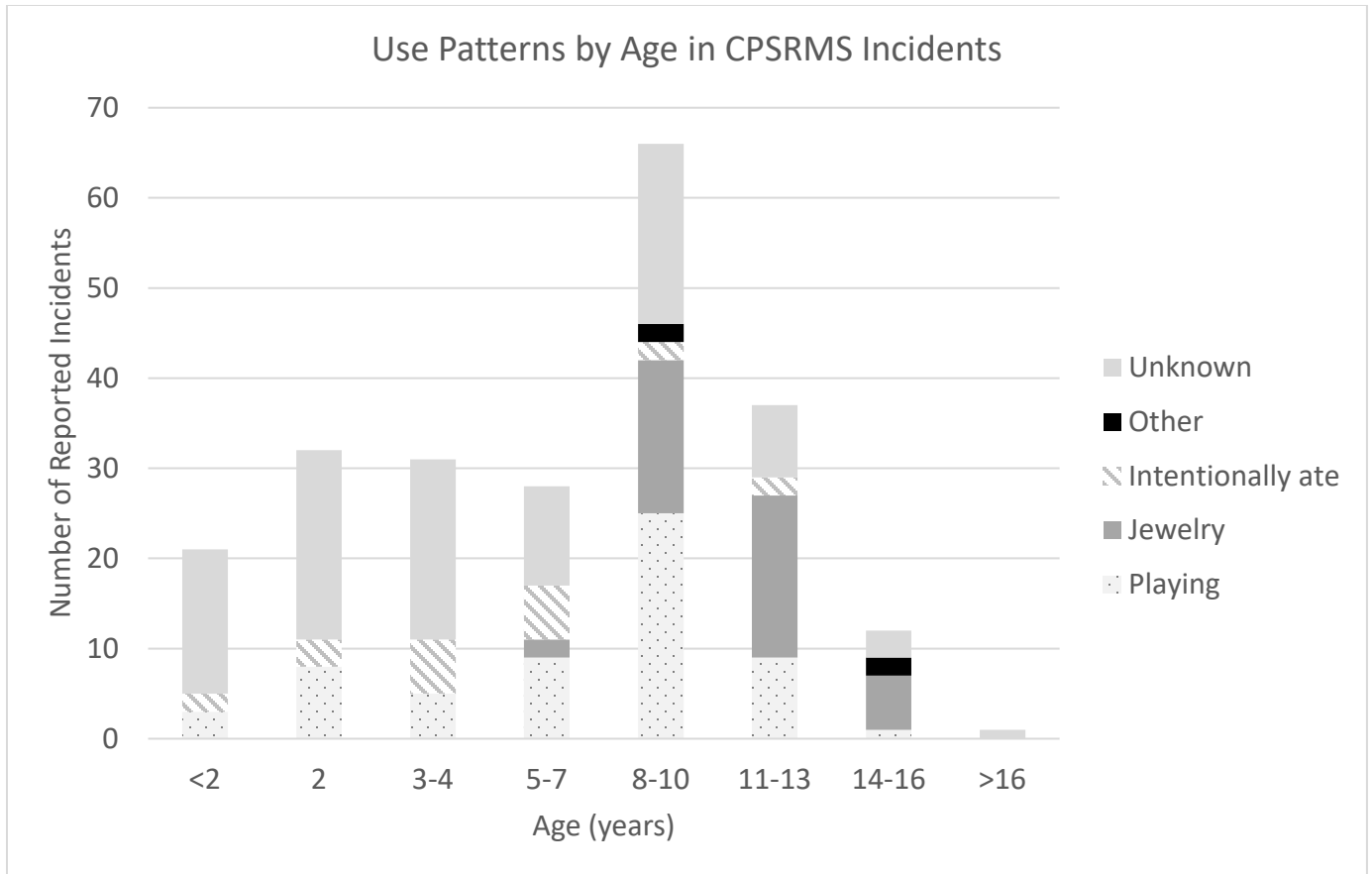

Figure 4: Magnet ingestion incidents, by use pattern and age, for CPSRMS incidents.

As Figures 3 and 4 show, for incidents in which the use pattern was identified, the majority of victims accidentally ingested the magnets. A common example of these accidental ingestions is children using the magnets in or around their mouths when the magnets unexpectedly rolled to the back of their throats and were ingested, in some cases by swallow reflex. This is consistent with normal child development, including exploration and the likelihood that children will be drawn to magnets aesthetically, and to their invisible attraction and repulsion properties. Consistent with developmental factors, younger children, particularly those under 8 years old, were more likely than older children to be involved in reports of intentional magnet ingestion (only 4 reports of intentional ingestion involved children 8 years old and older). The frequency of accidental ingestions suggests that safety messaging may have

limited effectiveness in addressing magnet ingestions, because children and caregivers are unlikely to anticipate and appreciate the likelihood of accidental ingestion of magnets.

Victims 8 years old and older were more likely than younger ages to swallow magnets while simulating piercings. It is foreseeable for this age group to use magnets as jewelry in or around their mouths, because experimentation and peer influence are common determinants of behavior for this age group. Older children and teens often value acceptance by peers more than obeying parental guidelines, and social influences and peer pressure can drive adolescent behavior more strongly than their own independent thought processes. The subject magnet products offer a seemingly safe and reversible way to try out lip, tongue, cheek, and nose piercings. If these children see their peers performing this activity, they may feel compelled to act similarly, even if they are aware of the risks. Furthermore, older children and early adolescents are at a developmental stage in which they test limits and bend rules.

3. Post-Ingestion Response

Staff also assessed incident data for information about how victims and caregivers behaved after a magnet ingestion event, including whether caregivers became aware of the ingestion, and the time between ingestion and treatment. Staff found that the invasiveness of medical interventions was often associated with the length of delay between the ingestion event and correct medical treatment. At least 56 of the 257 CPSRMS incidents (22 percent) involved a delay of several days between ingestion and correct treatment, with some delays spanning months. At least 16 additional incidents (6 percent) involved a delay of 1 day.

One common cause of delays was caregivers being unaware of the ingestion, resulting in delayed hospital visits and subsequent misdiagnoses. In many cases, particularly those involving children under 8 years old, caregivers were not aware that magnets were ingested. These cases

often involved ingestions that were not witnessed by caregivers, and where the children were unable or unwilling to communicate what happened.

Another common cause of delays was caregivers misunderstanding the hazard, such as expecting the magnets to pass naturally. Whether ingested magnets will pass naturally depends on several factors, including the number of magnets ingested, whether the magnets interact through tissue, and whether the interaction is strong enough to resist natural bodily forces. Similarly, delays in care often result when caregivers and children fail to make the connection between the magnet ingestion and symptoms, because there is frequently a time delay between magnet ingestion and symptoms, and because preliminary symptoms typically are similar to common illnesses. Many cases detail victims receiving treatment only after experiencing significant discomfort, at which point substantial internal damage had occurred. For example, one report indicates that in 2017, a 3-year-old child was found playing with an older sibling's magnet set, but stated that she had not swallowed any magnets. Days after the incident, the child became ill and was misdiagnosed with a stomach virus. Eventually, x-rays were taken, revealing three magnets in her small intestine. The victim lost a portion of her digestive tract and was hospitalized for approximately 2 weeks to recover after the surgery.

4. Sources of Access

Staff also examined incident data to determine how and from whom victims acquired magnets they ingested. Because most NEISS reports (97 percent) did not include sufficient information to determine the source of access, staff focused on CPSRMS incidents.

Table 14 shows the source of access for the 257 CPSRMS magnet ingestion incidents. The table includes incidents in the magnet sets, magnet toys, and jewelry categories, as well as incidents in the unidentified product type category.⁷²

Table 14: Magnet Ingestion Incidents, by Source of Access, for CPSRMS data.

Sources of Access	CPSRMS (#)	CPSRMS (%)	Description
Family Owned	59	23%	Magnets belonged to the victim’s family. Includes cases of siblings finding magnets and bringing them home.
Friend/Classmate/School/Neighbor	41	16%	Magnets belonged to friends, classmates, or neighbors, or the victim found them at daycare or school.
Purchased for Victim	26	10.1%	Magnets purchased for the victim.
Purchased by Victim	5	1.9%	Magnets purchased by the victim.
Found Outside	4	1.6%	Victim found the magnets outside, such as on a playground. Excludes cases of siblings finding magnets and bringing them home.
Unknown	122	47.5%	Unclear where the magnet was acquired, by whom, or for whom. Includes cases of magnets found in the home but where the product owner was unknown.
Totals:	257		

Percentages are rounded to the nearest tenth.

As Table 14 shows, of the 135 cases with a known source of access, most cases involved magnets that belonged to family members of the victim (44 percent), followed by magnets that victims acquired from friends, classmates, daycares, or schools (30 percent), and magnets purchased for the victim (19 percent). A small number of incidents involved magnets purchased by the victim (4 percent), or that the victim found outside (3 percent).

Victims under 8 years old typically gained access to magnets that belonged to family members, such as siblings, parents, and relatives. Magnets from family members were usually found on floors, in or on furniture, in bags, and affixed to surfaces (e.g., refrigerators, wallboards); and in some cases, family members intentionally shared the magnets with victims.

⁷² As explained above, several factors indicate that many of the incidents in the unidentified product type category likely involved subject magnet products, and these incidents indicate sources of access in magnet ingestion incidents, generally. The table excludes out-of-scope products (i.e., home/kitchen and ASTM F963 magnet toys).

In contrast, victims 8 years old and older typically obtained magnets from friends, classmates, or at school, or the magnets were purchased for them. Most cases involved children and teens acquiring loose magnets, as opposed to accessing the full set or product at the time of ingestion.

Staff also reviewed incident reports for information about product warnings and age labels on the ingested products, to determine if such warnings were present and considered by the victims and caregivers.⁷³ Of the 57 cases that reported whether there were product warnings, at least 45 (79 percent) involved products with a magnet ingestion warning. Similarly, of the 60 cases that reported whether there were age labels on the product, at least 49 (82 percent) involved products with a warning to keep the product away from children. At least 44 cases involved products with both magnet ingestion warnings and warnings to keep the product away from children. Recent magnet ingestion incidents, in 2021, which are not included in the above analysis, also indicate that there are numerous incidents in which involved magnet sets had clear and repeated warnings about the magnet ingestion hazard and warnings to keep the product away from children.

Staff further assessed incident data to determine the age of victims in incidents where the ingested magnets were purchased for or by the victims. Of the 133 cases with a known source of access and known victim age, about 23 percent involved magnets purchased for or by victims under 14 years old, including 9 cases in which the magnets were purchased for victims under 8 years old. Despite the ages of these victims, these cases involved products that were not marketed for children under 14 years old, and were not subject to the toy standard. For example, in one case, a parent purchased a magnet set for a 9-year-old child, despite there being clear and repeated warnings about the magnet ingestion hazard and warnings to keep the product away

⁷³ In most cases, there was insufficient information to determine if the involved products had warnings, age labels, or both.

from children. In another case, a caregiver gave the same product to a 5-year-old child, believing the product to be harmless, and believing that swallowed magnets would pass naturally. The child swallowed the magnets, and required surgery, including an appendectomy, because the magnets attracted internally through tissue.

Based on technical analysis and examination of incident reports, online and on-package marketing, and consumer reviews for subject magnet products, staff identified the following factors that likely contribute to children accessing magnet products that are intended for older users: caregivers and victims underestimate the potential severity of the hazard; social pressures from children, other family members, and friends; consumers see subject magnet products or similar products marketed to children; consumers see other children handling subject magnet products or similar products without incident; consumers read product reviews about other children handling subject magnet products or similar products without incident; and caregivers underestimate the likelihood that children or teens would ingest a magnet.

This information has implications for the types of requirements that are likely to effectively reduce the magnet ingestion hazard. For one, it indicates that requirements that rely on caregiver intervention, such as safety messaging and packaging requirements, are unlikely to adequately address the hazard. As the data suggest, caregivers cannot easily manage children's and teen's access to magnet products, since children and teens often access them outside the home. There are additional reasons why these requirements are unlikely to adequately address the hazard. As these data suggest, many incidents involve children and teens accessing ingested magnets without their packaging, making safety messaging and packaging ineffective. In addition, many incidents involve products that included safety messaging and age recommendations that consumers did not follow. Similarly, these data suggest that the toy

standard, alone, cannot adequately address the magnet ingestion hazard because children and teens purchase, receive, and access magnets from products that are not intended for their ages.

V. Relevant Existing Standards⁷⁴

CPSC identified six existing safety standards that address the magnet ingestion hazard. Each of these standards applies to certain products, and none of the standards apply to all subject magnet products. Four of the standards are domestic voluntary standards:

- ASTM F963-17, *Standard Consumer Safety Specification for Toy Safety*;
- ASTM F2923-20, *Standard Specification for Consumer Product Safety for Children's Jewelry*;
- ASTM F2999-19, *Standard Consumer Safety Specification for Adult Jewelry*; and
- ASTM F3458-21, *Standard Specification for Marketing, Packaging, and Labeling Adult Magnet Sets Containing Small, Loose, Powerful Magnets (with a Flux Index ≥ 50 kG2 mm²)*.

In addition, two are international safety standards:

- EN 71-1: 2014, *Safety of Toys; Part 1: Mechanical and Physical Properties*; and
- ISO 8124-1: 2018, *Safety of Toys — Part 1: Safety Aspects Related to Mechanical and Physical Properties*.

This section describes these standards and provides CPSC staff's assessment of their adequacy to address injuries and deaths associated with magnet ingestions. Several of the standards include requirements that do not relate to magnets, however, this analysis focuses on those provisions that are relevant to the magnet ingestion hazard.

⁷⁴ For additional information about relevant existing standards, see Tab C and Tab D of the NPR briefing package.

A. ASTM F963-17

ASTM F963 was originally approved in 1986, and has been revised numerous times since then. In 2007, ASTM updated the standard to include requirements to address the magnet ingestion hazard in children’s toys. In subsequent revisions, ASTM added further requirements for toys containing magnets. As explained above, in 2008, section 106 of the CPSIA made ASTM F963 a mandatory consumer product safety standard; in accordance with that mandate, the Commission adopted 16 CFR part 1250, which currently incorporates by reference ASTM F963-17, which is the most recent version of the standard. ASTM approved ASTM F963-17 on May 1, 2017 and published it in August 2017. CPSC staff participates in the ASTM F15.22 subcommittee that is responsible for this standard.

1. Scope

ASTM F963-17 applies to “toys,” which the standard defines as objects designed, manufactured, or marketed as playthings for children under 14 years old. As such, the standard does not apply to products that are intended for users 14 years or older, or products that would not be considered playthings. When ASTM adopted the provisions regarding magnets, it explained that the purpose of the requirements was to address magnet ingestion incidents resulting in serious injury or death by identifying magnets and magnetic components that can be readily swallowed (section A9.4).

2. Performance Requirements for Magnets

The standard specifies that toys may not contain a loose as-received “hazardous magnet” or a loose as-received “hazardous magnetic component.” In addition, toys may not liberate a “hazardous magnet” or “hazardous magnetic component” after specified use-and-abuse testing, which consists of soaking under water, cycling attachment and detachment, drop testing, torque

testing, tension testing, impact testing, and compression testing. The standard excepts from the requirements “magnetic/electrical experimental sets” intended for children 8 years and older—such products need only comply with warning requirements, discussed below.

The standard defines a “hazardous magnet” as a magnet that is a small object (*i.e.*, fits entirely within a small parts cylinder specified in the standard) and has a flux index of 50 $\text{kG}^2 \text{mm}^2$ or more (as measured in accordance with the method specified in the standard). Thus, a magnet must be both small and strong, according to the criteria in the standard, to be “hazardous.” A “hazardous magnetic component” is any part of a toy that is a small object and contains an attached or imbedded magnet with a flux index of 50 $\text{kG}^2 \text{mm}^2$ or more.

ASTM F963-17 describes the small parts cylinder in section 4.6 and illustrates it in Figure 3; to be a small object, the magnet must fit entirely within the cylinder. The small parts cylinder depicted in ASTM F963-17 is the same as the small parts cylinder in CPSC’s regulations, at 16 CFR 1501.4. Sections 8.25.1 through 8.25.3 describe the test methodology to measure the maximum absolute flux of a magnet and to calculate the flux index. A flux index is a calculated value of magnetic density and size. The flux index of a magnet is calculated by multiplying the square of the magnet’s maximum surface flux density (in KGauss (kG)) by its cross-sectional area (in mm^2).

3. *Warning Requirements*

ASTM F963-17 does not include specific labeling requirements for toys containing loose as-received hazardous magnets or hazardous magnetic components, except for “magnetic/electrical experimental sets” intended for children 8 years and older, which are exempt from the performance requirements and need only meet labeling requirements. The standard defines a “magnetic/electrical experimental set” as a “toy containing one or more

magnets intended for carrying out educational experiments that involve both magnetism and electricity.” Section A12.4 in the standard explains that this definition is intended to cover only products that combine magnetism and electricity. The packaging and instructions for magnetic/electrical experimental sets intended for children 8 years and older must be labeled with a warning that addresses the magnet ingestion hazard.

4. *Assessment of Adequacy*

CPSC staff does not consider ASTM F963-17 capable of adequately reducing the risk of injury and death associated with magnet ingestions because of the scope of products it covers.

The size and strength requirements in ASTM F963-17 are consistent with the requirements proposed in this rule for subject magnet products. **Section VI. Description of and Basis for the Proposed Rule**, below, discusses these size and strength requirements and their ability to address the hazard. Staff considers the size and strength requirements adequate to address the hazard. However, ASTM F963-17 only applies to products designed, manufactured, or marketed as playthings for children under 14 years old; it does not apply to products intended for older users or products that would not be considered playthings. Accordingly, staff does not believe that compliance with the standard is likely to adequately reduce the magnet ingestion hazard.⁷⁵

As the incident data indicate, children and teens commonly access and ingest magnets from products intended for older users. Both NEISS and CPSRMS data indicate that the most common products identified in magnet ingestions were magnet sets and magnet toys, which are products that are intended for users 14 years or older, or where the intended user age was

⁷⁵ Based on incident data, staff believes that the exception in ASTM F963-17 for magnetic/electrical experimental sets intended for children 8 years and older is likely not problematic for adequately addressing the magnet ingestion hazard. Staff identified only one magnet ingestion incident that involved a “science kit,” which potentially could be a magnetic/electrical experimental set.

unknown, but there were no indications that the product was intended for users under 14 years. Despite the involvement of products intended for users 14 years and older, the vast majority of magnet ingestion incidents involved children under 14 years old. For example, among CPSRMS incidents for which the victim's age was known, the most common ages that ingested magnet sets were 2, 8, 9, and 10 years old.

The sources from which children access ingested magnets further illustrates the need to address magnets in products intended for older users. For example, according to CPSRMS data, children and teens commonly access ingested magnets that belong to other family members, in the home, from friends, or loose in the environment, suggesting their access is not limited to toys intended for them.

In addition, ASTM F963-17 does not apply to products that are not intended to be playthings. Both NEISS and CPSRMS data indicate that many products involved in magnet ingestion incidents are described as jewelry, and that children of various ages ingest magnet jewelry (*e.g.*, accidentally ingesting magnets while simulating lip, tongue, and cheek piercings). Because ASTM F963-17 only applies to playthings, it does not apply to jewelry, regardless of the intended user age.

As such, ASTM F963-17, alone, is not sufficient to address the magnet ingestion hazard, because it does not impose any requirements on products intended for users 14 years or older or jewelry, which are known to be involved in many magnet ingestion incidents.

B. ASTM F2923-20

ASTM first issued ASTM F2923 in 2011. The current version of the standard is ASTM F2923-20, which was approved on February 1, 2020, and published in March 2020.

1. Scope

ASTM F2923-20 applies to “children’s jewelry,” which is jewelry designed or intended primarily for use by children 12 years old or younger. The standard defines “jewelry” as a product that is primarily designed and intended as an ornament worn by a person. The standard does not apply to toy jewelry or products intended for a child when playing. The standard includes requirements that are intended to address ingestion, inhalation, and attachment hazards associated with children’s jewelry that contains a hazardous magnet or hazardous magnetic component. The standard defines a “hazardous magnet” and “hazardous magnetic component” by referencing the definition in ASTM F963, except that the standard exempts chains that are longer than 6 inches from the definition of “hazardous magnetic component.”

2. Performance Requirements for Magnets

ASTM F2923-20 prohibits children’s jewelry from having an as-received hazardous magnet or hazardous magnetic component. The standard excepts from this requirement children’s jewelry intended for children 8 years and older consisting of earrings, brooches, necklaces, or bracelets—such products need only comply with warning requirements, discussed below. In addition, the standard prohibits children’s jewelry from liberating a hazardous magnet or hazardous magnetic component after the use-and-abuse testing specified in ASTM F963.

3. Warning Requirements

ASTM F2923-20 does not include specific labeling requirements for children’s jewelry containing hazardous magnets or hazardous magnetic components, except for children’s jewelry intended for children 8 years and older that consists of earrings, brooches, necklaces, or bracelets. These products are exempt from the performance requirements and need to include a

warning that addresses the magnet ingestion hazard. Instructions that accompany the product must also include these warnings.

4. *Assessment of Adequacy*

CPSC staff does not consider ASTM F2923-20 capable of adequately reducing the risk of injury and death associated with magnet ingestions. Although staff considers the size and strength requirements in the standard adequate to address the magnet ingestion hazard, the standard excepts certain children's jewelry from these performance requirements, and the scope of products covered by the rule makes the standard insufficient to address the magnet ingestions, generally.

The first issue with the standard is that it excludes from the size and strength requirements for magnets children's jewelry that is intended for children 8 years and older that consists of earrings, brooches, necklaces, and bracelets. Applying only warning requirements to these products is not adequate to reduce the magnet ingestion hazard. As the incident data indicate, almost half of magnet ingestion incidents involve children 8 years and older, and children and teens, particularly in this age group, commonly used magnets as jewelry at the time of ingestion. Warning requirements, alone, are not adequate to address these incidents. As the discussion of ASTM F3458-21, below, covers in detail, caregivers and children commonly do not heed warnings, and children and teens commonly access magnets that are separated from their packaging, where warnings are provided.

The second issue with the standard is that it applies only to jewelry that is designed or intended primarily for use by children 12 years old or younger. As such, it does not impose requirements on magnet sets or magnet toys intended for users 14 years and older, which are the most common product types identified in magnet ingestion incidents. The standard also does not

apply to jewelry intended for users over 12 years old. Although incident data do not indicate the intended user age of jewelry products involved in ingestions, the data indicate that children and teens of various ages ingested magnets intended for users 14 years and older when using the magnets as jewelry, making it is reasonable to conclude that jewelry intended for users over 12 years old poses an ingestion hazard for children and teens.

For these reasons, ASTM F2923-20, on its own, is not sufficient to address the magnet ingestion hazard because it does not impose requirements on magnet sets, magnet toys, or certain jewelry, which are shown to be involved in many magnet ingestion incidents.

C. ASTM F2999-19

ASTM first issued ASTM F2999 in 2013; the current version of the standard is ASTM F2999-19, which ASTM approved on November 1, 2019, and published in November 2019.

1. Scope

ASTM F2999-19 establishes requirements and test methods for certain hazards associated with adult jewelry, including magnets. The standard defines “adult jewelry” as jewelry designed or intended primarily for use by consumers over 12 years old. It defines “jewelry” as a product primarily designed and intended as an ornament worn by a person, and provides several examples, such as bracelets, necklaces, earrings, and jewelry craft kits where the final assembled product meets the definition of “jewelry.” The standard defines a “hazardous magnet” as “a magnet with a flux index >50 as measured by the method described in Consumer Safety Specification F963 and which is swallowable or a small object.”

2. Performance Requirements for Magnets

ASTM F2999-19 does not include any performance requirements for adult jewelry that contains magnets; it specifies only labeling requirements, discussed below.

3. *Labeling Requirements*

ASTM F2999-19 states that “adult jewelry that contains hazardous magnets as received should include a warnings statement which contains the following text or substantial equivalent text which clearly conveys the same warning.” Thus, rather than the mandatory language ASTM standards typically use (*i.e.*, shall), the standard merely recommends (*i.e.*, should) that warnings regarding hazardous magnets be provided with adult jewelry. The warning statement provided in the standard warns of the internal interaction hazard if magnets are swallowed or inhaled, and recommends seeking immediate medical attention.

4. *Assessment of Adequacy*

CPSC staff does not consider ASTM F2999-19 capable of adequately reducing the risk of injury and death associated with magnet ingestions. For one, the standard does not include any requirements for adult jewelry containing magnets—rather, it suggests complying with the magnet provisions. As incident data indicate, many magnet ingestion incidents involve products used as jewelry, and children and teens accessing products intended for older users. This demonstrates the need for a mandatory requirement for adult jewelry.

In addition, the only provisions in the standard that address magnet ingestions are warnings. As the discussion of ASTM F3458-21, below, covers in detail, warning requirements, alone, are not adequate to address the magnet ingestion hazard because caregivers and children commonly do not heed warnings, and children and teens commonly access magnets that are separated from their packaging, where warnings are provided.

The scope of the standard also makes it insufficient to adequately address the magnet ingestion hazard. Because it applies only to jewelry designed or intended primarily for use by consumers over 12 years old, the standard does not impose requirements on magnet sets or

magnet toys intended for users 14 years and older, which are the most common products identified in magnet ingestion incidents. It also does not impose requirements on jewelry intended for users 12 years old and younger. Although the incident data do not indicate the intended user age of jewelry involved in magnet ingestions, because many incidents involve children 12 years old and younger, it is reasonable to conclude that jewelry intended for such users pose the magnet ingestion hazard for children and teens.

Another potential issue with ASTM F2999-19 is that it defines a hazardous magnet, for purposes of determining whether the warning provisions apply, as having a flux index greater than $50 \text{ kG}^2 \text{ mm}^2$. In contrast, ASTM F963-17, ASTM F2923-20, and this proposed rule, define a hazardous magnet as having a flux index greater than or equal to $50 \text{ kG}^2 \text{ mm}^2$, thereby, addressing magnets with a flux index of precisely $50 \text{ kG}^2 \text{ mm}^2$. This makes ASTM F2999-19 inconsistent with the toy standard, which has been in effect for many years and has been effective at addressing the magnet ingestion hazard for toys.

For these reasons, ASTM F2999-19, alone, is not sufficient to address the magnet ingestion hazard because it does not impose performance requirements on magnet sets, magnet toys, or certain jewelry, which are involved in many magnet ingestion incidents.

D. ASTM F3458-21

In 2019, ASTM Subcommittee F15.77 on Magnets began work to develop a standard for magnet sets intended for users 14 years and older. On February 15, 2021, ASTM approved ASTM F3458-21, and published the standard in March 2021. ASTM F3458-21 consists of marketing, packaging, labeling, and instructional requirements for magnet sets intended for users 14 years and older.

Since March 2019, CPSC staff has participated actively in Subcommittee F15.77 on Magnets. During the development of ASTM F3458-21, CPSC staff raised several concerns to the subcommittee about the developing standard, including the reliance on marketing, packaging, labeling, and warnings requirements, rather than performance requirements to limit the size and strength of magnets. The assessment of the standard, below, and Tab C of the NPR briefing package, detail these concerns; Tab C also includes a letter CPSC staff sent the subcommittee, expressing these concerns. Based on these issues, CPSC considered the standard inadequate to address the magnet ingestion hazard and voted against the final version of the standard that was ultimately adopted.

In May 2021, after ASTM F3458-21 was adopted, Subcommittee F15.77 on Magnets voted to form a task group to consider revising the standard to include performance requirements for magnet sets intended for users 14 years and older. CPSC staff will continue to work with the subcommittee, however, whether the standard will be revised, and what requirements may be added to it, are, as yet, undetermined.

1. Scope

ASTM F3458-21 aims to minimize the hazards to children and teens associated with ingesting small, powerful magnets in magnet sets that are intended for users 14 years and older. The standard defines a “magnet set” as “an aggregation of separable magnetic objects that are marketed or commonly used as a manipulative or construction item for puzzle working, sculpture building, mental stimulation, education, or stress relief.” It also defines a “small, powerful magnet” as an “individual magnet of a magnet set that is a small object” and has a flux index of $50 \text{ kG}^2 \text{ mm}^2$ or more. The criteria for identifying a small object and the flux index are the same as in ASTM F963-17.

2. *Performance Requirements for Magnets*

The standard does not include size and strength limits for magnet sets themselves. The standard includes performance criteria in the form of test methods to determine if a product is a “small, powerful magnet,” and test methods for assessing label permanence; however, the standard does not include performance requirements preventing small, powerful magnets from being used in magnet sets. Instead, ASTM F3458-21 includes requirements for instructional literature, sales/marketing, labeling, and packaging, discussed below. These requirements seek to inform and encourage consumers to keep magnets away from children.

3. *Instructional Literature Requirements*

ASTM F3458-21 requires magnet sets intended for users 14 years and older to come with instructions that address assembly, maintenance, cleaning, storage, and use. The instructions must include warnings (as specified below), the manufacturer’s suggested strategy for counting and storing magnets, a description of typical hazard patterns (*e.g.*, young children finding loose magnets), an illustration of the hazard, a description of typical symptoms associated with magnet ingestion, and statements regarding medical attention when magnets are ingested.

4. *Sales/Marketing Requirements*

The standard prohibits manufacturers from knowingly marketing or selling magnet sets intended for users 14 years and older to children under 14 years old, and requires them to “undertake reasonable efforts” (with examples) to ensure the product is not marketed or displayed as a children’s toy. For online sales, manufacturers must “undertake reasonable efforts” (with examples) to ensure that online sellers do not sell magnet sets intended for users 14 years and older to children under 14 years. When selling directly to consumers online,

manufacturers must include warnings (as specified below) and instructional literature about the hazard pattern.

5. Labeling Requirements

ASTM F3458-21 requires magnet sets intended for users 14 years and older to bear warnings on the retail packaging and “permanent storage container,” which the standard defines as a container designed to hold the magnet set when it is not in use. At a minimum, the warnings must address the hazard associated with magnet ingestions, direct users to keep the product away from children, and provide information about medical attention. The standard includes an example warning label, and specifies design and style requirements for the warning label. In addition, the standard requires the label to be permanent and provides a test method for assessing label permanence.

6. Packaging Requirements

The standard requires magnet sets intended for users 14 years and older to be sold with or in a permanent storage container. The permanent storage container must include a way to verify that all the magnets have been returned to the container. In addition, the standard requires the permanent storage container to be re-closeable and include one of the following means of restricting the ability to open the container: (1) the container requires two consecutive actions, the first of which must be maintained while the second is carried out, or requires two separate and independent simultaneous actions to fully release, withstanding specified testing; (2) the container requires one action that requires at least 15 lbf to open or requires at least 4 inches lbf of torque to open, withstanding specified testing; or (3) the container meets the performance requirements in 16 CFR 1700.15 and the testing requirements of 16 CFR 1700.20 (which are poison preventing packaging standards, adopted under the Poison Prevention

Packaging Act⁷⁶ and specify packaging that is significantly difficult for children under 5 years old to open within a reasonable time).

7. *Assessment of Adequacy*

CPSC staff does not consider ASTM F3458-21 capable of adequately reducing the risk of injury and death associated with magnet ingestions. For one, the limited scope of products subject to the standard is inadequate to address the hazard. The standard only applies to magnet sets intended for users 14 years and older. As such, it imposes no requirements on other products intended for users 14 years and older, or on jewelry (both children's and adult), which are shown to be involved in magnet ingestion incidents.

In addition, the types of requirements in the standard make it inadequate to address the magnet ingestion hazard. For a detailed discussion of the weaknesses of warnings, instructional, sales/marketing, and packaging requirements to address the magnet ingestion hazard, see Tab C of the NPR briefing package. The following is an overview of these weaknesses.

Throughout the standard development process, CPSC staff emphasized that performance requirements for magnets are necessary to adequately address the magnet ingestion hazard. Such requirements typically include size and strength requirements for the magnets themselves, as in the toy standard and this proposed rule. However, ASTM F3458-21 does not include performance requirements to prevent magnet sets intended for users 14 years and older from containing small, powerful magnets, and instead, relies on requirements to inform and encourage consumers to keep magnets away from children. As incident data indicate, children and teens access magnet products, including magnet sets, that are intended for older users, making it important to address the magnet ingestion hazard for magnet sets intended for users 14 years and

⁷⁶ 15 U.S.C. 1471-1477.

older. However, safety messaging (e.g., warnings and instructions) and packaging requirements, without performance requirements for the magnets themselves, are not likely to adequately address the hazard.

Safety Messaging. Safety literature has shown that warnings are the least effective strategy for addressing a hazard, relative to designing out the hazard or designing guards against the hazard. This is because safety messaging relies on persuading consumers to avoid hazards, but numerous factors can reduce the likelihood that consumers will read and follow safety messaging.

One factor that weighs against consumers heeding safety warnings is their perception that magnet products present a low safety risk. Magnets in products intended for amusement or jewelry are likely to appear simple, familiar, and non-threatening to children, teens, and caregivers. Incident data and consumer reviews demonstrate that consumers commonly recognize these types of magnetic products as suitable playthings for children, which undermines the perceived credibility of warnings that state the magnets are hazardous for children. The availability of children's toys that are similar to subject magnet products intended for users 14 years and older may also affect consumers' perception of the hazard because the products appear similar, and some are marketed for children. Once familiar with a product, consumers tend to generalize across similar products, and the more familiar consumers are with a product, the less likely they are to look for, or read, warnings and instructions. If caregivers observe their child, or their child's peers using a product or a similar product without incident, caregivers may conclude that their child can use the product safely, regardless of what the warnings state. This is also true for recommendations from others, including online reviews of products, which can influence the likelihood of consumers disregarding warnings. Staff reviewed numerous consumer reviews of

subject magnet products, and found that many indicated that consumers purchased the product for a child, or that their children started playing with it, despite the product not being intended for users under 14 years old. Similarly, when a child or teen repeatedly uses the product in or around their mouth without ingesting a magnet or experiencing consequences from ingestion, they and their caregivers are likely to conclude that the hazard is not likely to occur, or is not relevant to them.

Another reason that safety messaging has limited effectiveness is that consumers misunderstand the hazard. For small, powerful magnets, the internal interaction hazard is a hidden hazard, so consumers are unlikely to anticipate and appreciate the risk to children, especially older children and teens who do not have a history of mouthing or ingesting inedible objects. However, of the magnet ingestion cases that identify whether the ingestions were intentional or accidental, the majority describe accidental ingestions, which is much more difficult for consumers to appreciate and prevent.

Similarly, there are developmental factors that predispose older children and teens to disregard warnings and use the small, powerful magnet products in and around their mouths and noses. As discussed above, older children and teens are at a developmental stage in which they test limits and bend rules. Experimentation and peer influence are common determinants of behavior for this age group. Small, powerful magnets offer a seemingly safe and reversible way to try out lip, tongue, cheek, and nose piercings; and if children and teens see their peers doing this, they may act similarly, despite being aware of the risks.

In addition, consumers misunderstand the progression of symptoms associated with magnet ingestions, which may lead them to disregard warnings. As incident reports show, many children, teens, and caregivers wrongly assume that, when ingested, magnets will pass through

the body without causing harm. This contributes to delays between ingestion and correct treatment, increasing the risks associated with magnet ingestion.

Another factor that limits the potential effectiveness of safety messaging is how children and teens obtain magnets they ingest. As incident data show, children and teens commonly obtain ingested magnets loose in their environments, from friends, or at school, where the product is separated from any packaging or instructions that bear warnings. Because small, powerful magnets themselves are too small to bear warnings, these children and teens, and their caregivers, may not be made aware of the hazard.

Finally, safety messaging has been ineffective at reducing the magnet ingestion hazard, to date. As discussed above, and in Tab C of the NPR briefing package, staff has examined dozens of incident reports that indicate children and teens obtained and ingested small, powerful magnets even when the product was marketed and prominently labeled with warnings about the hazard and stated that the product was not appropriate for children. For example, of the CPSRMS incidents reported to have occurred between January 1, 2010 and December 31, 2020, staff examined at least 44 incidents in which a child ingested a magnet product that included warnings about the hazard and cautioned to keep the product away from children. Similarly, of 41 magnet sets for which staff assessed consumer reviews, 35 percent of the reviews mentioned use by children, despite 68 percent including a warning about the magnet ingestion hazard.

Another indication of the ineffectiveness of safety messaging to address the magnet ingestion hazard, to date, is the upward trend in magnet ingestion cases in recent years, despite many years of consumer awareness campaigns. As discussed above, for many years, CPSC has drawn attention to the magnet ingestion hazard through recalls, safety alerts, public safety bulletins, and rulemaking activity. In addition, there have been numerous public outreach efforts

by health organizations and other consumer advocacy groups to warn consumers about the internal interaction hazard posed by small, powerful magnets. Despite these efforts, magnet ingestion incidents have increased in recent years.

Packaging. Similar to safety messaging, there are several reasons staff considers packaging requirements inadequate to address the magnet ingestion hazard. For one, incident data show that children and teens commonly access ingested magnets loose in their environment and from friends, in which case the product is likely to be separated from its packaging, rendering CR packaging or visual cues that all magnets are in the package ineffective.

In addition, the features provided for in ASTM F3458-21 to make the packaging difficult for children to open would not be effective at preventing older children and teens from accessing the magnets in the packaging. For example, the third packaging option provided in the standard allows the packaging to meet the requirements in 16 CFR 1700.15 and 1700.20. Those provisions are intended to make packaging significantly difficult for children under 5 years old to open within a reasonable time. Thus, such packaging does not prevent all children under 5 years old from opening it, particularly given ample time, and it is not intended to prevent any children 5 years and older from opening the packaging. As the incident data indicate, the majority of magnet ingestion incidents involved victims 5 years and older, making this packaging ineffective at restricting their access. Similarly, for the alternative packaging options in the standard, children and teens are likely to have cognitive and motor skills sufficient to access the products.

Even if CR packaging features did prevent children and teens from opening the packaging, the effectiveness of packaging to address the hazard would rely on consumers correctly repackaging all the magnets after every use, which is likely unrealistic. For one, the products often are intended for purposes that make repackaging after each use unlikely. For

example, products such as magnet sets are intended to assemble and display complex sculptures, and some jewelry may involve creating designs, making consumers unlikely to disassemble their designs to repackage all the magnets after every use. In addition, consumers are not likely to perceive the products as hazardous because they are intended for amusement or jewelry and are not hazardous in appearance, and therefore, would not consider it necessary to repackage all the magnets after every use. Even for products that are obviously hazardous and commonly use CR packaging, such as chemicals and pharmaceuticals, consumers have inconsistently used the packaging. Consumers may also consider CR packaging a nuisance, making them unlikely to store magnets in the packaging after every use.

In addition, the small size of the magnets and large number of magnets (particularly in some magnet sets and magnetic jewelry sets), make it unlikely that consumers would return all the magnets to the packaging after every use. The small size and often large quantity of magnets in a set make locating and counting the magnets after every use, to ensure they are all returned to the package, not feasible or realistic. For example, staff has identified products that were involved in magnet ingestion incidents that consisted of thousands of 2.5 mm diameter magnets. Staff has found that it is common for magnets to be flicked away from one another when they are being handled, such as when separating magnets, resulting in magnets being dropped. These actions are foreseeable, particularly for magnets intended for fidgeting and building. In examining magnet sets, staff found that many sets are sold with extra pieces, in part, because losing magnets is expected. In addition, many incident reports and consumer reviews of magnet sets mention lost magnets. Given the large number of magnets often included in a set, their small size, and their tendency to be separated and lost, it is unlikely that consumers will use CR

packaging effectively. The time and effort necessary to locate, assemble, and repackage such small and numerous magnets is likely to be beyond what consumers are willing to spend.

For these reasons, ASTM F3458-21, alone, is not sufficient to address the magnet ingestion hazard because it does not impose performance requirements on magnets themselves, and it does not apply to several products that are involved in magnet ingestion incidents.

E. EN 71-1: 2014

The European standard applies to children's toys, which are products intended for use in play by children younger than 14 years old. The requirements regarding magnets in EN 71-1: 2014 are essentially the same as in ASTM F963-17—any loose as-received magnet and magnetic component must either have a flux index less than $50 \text{ kG}^2 \text{ mm}^2$, or not fit entirely in a small parts cylinder. The flux index is determined using the same method as in ASTM F963-17, and the small parts cylinder is the same as in ASTM F963-17. EN 71-1: 2014 also requires use-and-abuse testing similar to ASTM F963-17, to ensure that toys do not liberate a hazardous magnet or hazardous magnetic component. The standard includes a similar exemption to ASTM F963-17 for magnetic/electrical experimental sets intended for children 8 years of age and older, which need only bear a warning regarding the magnet ingestion hazard.

Thus, the provisions addressing the magnet ingestion hazard in EN 71-1: 2014 are largely the same as in ASTM F963-17. As discussed above, for ASTM F963-17, CPSC staff does not consider these provisions capable of adequately reducing the risk of injury and death associated with magnet ingestions because of the limited scope of the standard. Because the standard only applies to toys intended for children under 14 years old, it does not impose any requirements on products intended for older users, or products that would not be considered playthings. As the

incident data indicate, magnet ingestion incidents include children and teens ingesting products intended for older users, and ingesting jewelry, neither of which this standard addresses.

F. ISO 8124-1: 2018

This standard applies to toys, which are products intended for use in play by children under 14 years old. The standard requires any loose as-received magnet and magnetic component to either have a flux index less than $50 \text{ kG}^2 \text{ mm}^2$ or not fit entirely within a small parts cylinder. The flux index is determined the same way as in ASTM F963-17, and the small parts cylinder is the same as in ASTM F963-17. ISO 8124-1 also requires similar use-and--abuse testing to ASTM F963-17, to ensure that a hazardous magnet or hazardous magnetic component does not liberate from a toy. Similar to ASTM F963-17, ISO 8124-1 also provides an exemption for magnetic/electrical experimental sets intended for children 8 years and older, which need only bear a warning regarding the magnet ingestion hazard.

Thus, the provisions addressing the magnet ingestion hazard in ISO 8124-1: 2018 are largely the same as in ASTM F963-17. As discussed above, for ASTM F963-17, CPSC staff does not consider these provisions capable of adequately reducing the risk of injury and death associated with magnet ingestions because of the limited scope of the standard. Because the standard only applies to toys intended for children under 14 years old, it does not impose any requirements on products intended for older users, or products that would not be considered playthings. As the incident data indicate, magnet ingestion incidents include children and teens ingesting products intended for older users, and ingesting jewelry, neither of which this standard addresses.

G. Compliance with Existing Standards

CPSC has limited information about the extent to which products comply with existing standards. Based on staff’s analysis, only a small number of magnet ingestion incidents for which a product type could be identified involved children’s toys subject to ASTM F963, which provides some indication that children’s toys commonly comply with the standard. Of the magnet ingestion incidents that involved children’s toys, staff identified six incidents that involved internal interaction of the magnets through body tissue, again suggesting there may be a high level of compliance with the standard. None of the products in these six incidents complied with the magnet requirements in ASTM F963.

CPSC staff does not have detailed information about the extent to which products comply with ASTM F2923, F2999, or F3458. Incident reports commonly do not provide enough detail for staff to identify the specific product (*e.g.*, brand) to obtain it and assess it for compliance. In addition, for ASTM F3458, the standard was adopted recently (March 2021), making it difficult to determine the level of compliance with it. CPSC seeks comments and data about the level of compliance with the existing standards that address the magnet ingestion hazard.

VI. Description of and Basis for the Proposed Rule

A. Scope and Definitions

1. Proposed Requirements

The proposed rule applies to “subject magnet products,” defined as “a consumer product that is designed, marketed, or intended to be used for entertainment, jewelry (including children’s jewelry), mental stimulation, stress relief, or a combination of these purposes, and that

contains one or more loose or separable magnets.” The proposed rule exempts from its scope, toys that are subject to 16 CFR part 1250, *Safety Standard Mandating ASTM F963 for Toys*.

The proposed rule only applies to “consumer products,” as defined in the CPSA, which are “article[s], or component part[s] thereof, produced or distributed (I) for sale to a consumer for use in or around a permanent or temporary household or residence, a school, in recreation, or otherwise, or (ii) for the personal use, consumption or enjoyment of a consumer in or around a permanent or temporary household or residence, a school, in recreation, or otherwise.” 15 U.S.C. 2052(a)(1). Consumer products do not include products that are not customarily produced or distributed for sale to, or for the use or consumption by, or enjoyment of, a consumer. *Id.*

The proposed rule also defines “hazardous magnets” as “a magnet that fits entirely within the cylinder described in 16 CFR 1501.4 and that has a flux index of 50 kG² mm² or more when tested in accordance with the method described in this part 1262.”

2. *Basis for Proposed Requirements*

To determine the appropriate scope of products to cover in the proposed rule to adequately reduce the risk of injury and death associated with magnet ingestions, CPSC staff considered magnet ingestion incident data, magnet use patterns, magnet ingestion rates when other mandatory standards took effect, recalls, child development and behavioral patterns, the uses of hazardous magnets in consumer products, consumer reviews for products with loose or separable hazardous magnets, existing standards, contributions from stakeholders in the ASTM Subcommittee F15.77 on Magnets, and relevant research literature. The definition of “subject magnet products” consists of several elements that include and exclude certain products from the scope of the proposed rule. This section discusses the reasons for the criteria in the definition.

The basis for the elements of the proposed definition of “hazardous magnets” is discussed below, as part of the basis for the performance requirements in the proposed rule.

a. Consumer Products

Subject magnet products are limited to “consumer products,” as that term is defined in the CPSA. Accordingly, any product that is not customarily produced or distributed for sale to or use by a consumer, is not within the scope of the proposed rule. This could include professional, industrial, or commercial products that would not customarily be available to or used by consumers. This element of the definition is included because CPSC’s authority under the CPSA is limited to consumer products, and because products that are not customarily available to consumers would not be likely to pose a magnet ingestion hazard to children and teens.

b. Loose or Separable Magnets

Subject magnet products are limited to products that contain “loose or separable magnets.” This is because magnets that are not loose or separable, such as non-removable magnets that are integrated into or attached to a product, would not pose an ingestion hazard. For example, a magnetic clasp attached to a necklace would not pose an ingestion hazard because it is connected to a larger object, making it unlikely to be swallowed.

In addition, the definition of “subject magnet products” specifically refers to magnets. Although not explicit in the definition, this refers to permanent magnets, which are magnets that maintain their magnetic field after being removed from the magnetizing source. Staff does not consider it necessary to specify that the standard applies to permanent magnets. For one, products that lose their magnetism when separated from their magnetizing source (*e.g.*, electromagnets that lose their magnetism when separated from the source of electricity) are unlikely to exceed the size criteria in the proposed rule when functioning as magnets because, to

be magnetized, the product would have to be attached to its magnetizing source, which would render the product too large to fit entirely within the small parts cylinder. When separated from its magnetizing source, thereby making the item potentially small enough to fit entirely in the small parts cylinder, the item would lose its magnetism, and no longer be a “magnet” subject to the standard. In addition, for the magnet to be “loose or separable” it would need to be a magnet (*i.e.*, magnetized) when loose and separated from other components, including a magnetizing source. CPSC seeks comments on whether it is necessary for the proposed rule to specify that it applies only to permanent magnets, or whether the rule should apply to non-permanent magnets as well.

c. One or More Magnets

The definition also specifies that subject magnet products include “one or more” loose or separable magnets; thus, they include products with only a single loose or separable magnet. There are two reasons for including this in the definition of “subject magnet products.” First, an individual magnet can interact internally through body tissue with an unrelated magnet or a ferromagnetic object, resulting in an internal interaction injury. Thus, even a product with a single loose or separable magnet poses the same internal interaction hazard as products with multiple magnets. Second, subject magnet products may be sold as individual magnets or with a choice of how many magnets to include in a set. Staff identified magnets sets on the market that are sold with extra pieces to serve as replacements for magnets lost from the set. Thus, magnets sold individually may be intended as, or may be used as, part of a set, posing the risk of children and teens ingesting more than one magnet. Limiting the proposed rule to products that include two or more loose or separable magnets would not address the hazard posed by a single magnet, and would leave a gap in the standard to allow firms to sell magnets individually, without having to

comply with the proposed rule. Moreover, applying the proposed rule to products that include a single loose or separable magnet is consistent with the toy standard in 16 CFR part 1250 because ASTM F963-17 applies to products that contain one or more hazardous magnets.

d. Amusement or Jewelry

The definition of “subject magnet products” is limited to products that are designed, marketed, or intended to be used for entertainment, jewelry, mental stimulation, stress relief, or a combination of these purposes. Essentially, this means that the proposed rule applies to products that are designed, marketed, or intended for amusement or jewelry. This section discusses the reasons CPSC considers it appropriate to focus on magnet products intended for amusement and jewelry to reduce the risk of injury and death associated with magnet ingestions. The focus on amusement and jewelry products is also consistent with international standards, which address these products, in particular.⁷⁷

Description of Products. Magnets intended for amusement include a variety of products for consumer entertainment, mental stimulation, and stress relief. Whether a product is designed, marketed, or intended to be used for these purposes depends on multiple considerations, such as how the manufacturer describes the product, marketing and advertising for the product, product packaging and displays, and how consumers are reasonably likely to perceive or use the product. Common examples of products that contain loose or separable magnets intended for entertainment, mental stimulation, or stress relief (other than children’s toys) include products commonly referred to as “executive toys,” “desk toys,” “magnet sets,” and “rock magnets.” Magnet sets generally are aggregations of separable magnets commonly used for manipulating or

⁷⁷ As discussed above, Canada’s efforts to address the magnet ingestion hazard have focused on products intended for amusement, and New Zealand’s and Australia’s efforts have focused on products intended for amusement and jewelry.

constructing sculptures. Rock magnets generally are loose magnets shaped like rocks and intended for entertainment or fidgeting. These are some examples, and additional products may be designed, marketed, or intended to be used for entertainment, mental stimulation, stress relief, or a combination of these purposes.

Subject magnet products that are jewelry also include a variety of products, such as jewelry intended for adults or for children, jewelry making sets, and magnetic piercings and studs. For example, staff has identified necklaces made of numerous small magnets, in multiple shapes, that consumers can rearrange in various configurations.

Incident Data. As the incident data indicate, magnet ingestion cases generally involve seven categories of magnet products (see section *IV.A. Incident Data*, above, for a detailed description of the categories): magnet sets, magnet toys, jewelry, home/kitchen magnets, ASTM F963 magnet toys, science kits, and unidentified products. Products categorized as magnet sets, magnet toys, and ASTM F963 magnet toys are generally intended for amusement, however, ASTM F963 magnet toys are excluded from the scope of the proposed rule.

As the incident data show, products categorized as amusement and jewelry, by far, are the most common product categories identified in magnet ingestion incidents. Table 1 shows that magnet toys, by far, were the most common product type category identified⁷⁸ in NEISS magnet ingestion incidents (110 of 279, or 39 percent), followed by magnet sets (58 of 279, or 21 percent), and jewelry (53 of 279, or 19 percent). The remaining identified product categories made up fewer of the magnet ingestion cases: home/kitchen magnets (46 of 279, or 16 percent), ASTM F963 magnet toys (11 of 279, or 4 percent), and science kits (1 of 279, or less than 1

⁷⁸ As explained above, for many NEISS incidents, there was insufficient information for staff to identify the category of magnet products involved. Of the 1,072 NEISS magnet ingestion incidents from 2010 through 2020, staff categorized 793 as “unidentified” magnet product types. For this reason, this analysis focuses on the remaining 279 incidents for which staff could categorize the product type.

percent). Thus, for NEISS magnet ingestion incidents in which the product category could be identified, 79 percent (221 of 279 incidents) involved products in the magnet sets, magnet toys, or jewelry categories.

CPSRMS data similarly show that magnet sets, magnet toys, and jewelry are the primary categories of products identified in magnet ingestions reports. As Table 9 shows, magnet sets, by far, were the most common product type identified⁷⁹ in CPSRMS magnet ingestion incidents, making up 56 percent (134 of 241) of the incidents for which product type categories could be identified, followed by magnet toys (49 of 241, or 20 percent), and jewelry (31 of 241, or 13 percent). The remaining identified product categories made up fewer of the magnet ingestion cases: ASTM F963 magnet toys (21 of 241, or 9 percent), home/kitchen magnets (6 of 241, or 2 percent), and 0 science kits. Thus, for CPSRMS magnet ingestion incidents in which the product category could be identified, 89 percent (214 of 241 incidents) involved products in the magnet sets, magnet toys, or jewelry categories.

The severity of health outcomes associated with magnet ingestions provides further support for focusing on amusement and jewelry products in the proposed rule. Fatalities are one indication of the severity of health outcomes. As discussed above, CPSC identified seven fatalities that involved the ingestion of hazardous magnets between November 24, 2005 and January 5, 2021, 5 of which occurred in the United States. CPSC was able to definitively identify one of the products involved in these incidents (a 2005 death in the United States), which was a children's toy building set, a product intended for amusement. In addition, the most recent incident (a 2021 death in the United States) involved a magnet set, which is also a product

⁷⁹ Like NEISS data, CPSRMS data also includes incidents for which there was insufficient information for staff to determine the category of magnet products involved. However, the proportion of incidents in the unidentified magnet product type category is much lower in CPSRMS than in NEISS data. Nevertheless, this analysis focuses on the 241 incidents for which staff could categorize the product type.

intended for amusement. Of the remaining five incidents, three incidents (a 2013 death in the United States and two deaths in other countries) involved magnets that matched the characteristics of magnets typically found in magnet sets, but did not identify the involved product with certainty; one incident (a 2018 death in the United States) involved magnets that matched the characteristics of magnets typically found in magnet sets, and the product was described consistently with magnet sets (*i.e.*, a magnet fidget toy building set); and one incident (a 2020 death in the United States) did not provide information about the product type. This suggests that amusement products, such as magnet sets, are involved in the most severe magnet ingestion cases.

Whether a victim was hospitalized after ingesting magnets provides another indication of the severity of injuries or the need for significant treatment. As Table 10 shows, using CPSRMS data, the most common product types identified⁸⁰ in magnet ingestion cases that resulted in hospitalization were magnet sets (88 of 160, or 55 percent), followed by magnet toys (36 of 160, or 23 percent), and jewelry (21 of 160, or 13 percent). Hospitalizations for the remaining identified magnet categories were much lower: ASTM F963 magnet toys (10 of 160, or 6 percent), and home/kitchen magnets (5 of 160, or 3 percent).⁸¹ Thus, for CPSRMS magnet ingestion incidents in which the product category could be identified, 91 percent (145 of 160 incidents) of hospitalizations involved magnet sets, magnet toys, or jewelry. Moreover, as Table 10 shows, magnet ingestions from magnet toys, magnet sets, and jewelry, all resulted in hospitalization far more often than they resulted in other non-hospitalization dispositions.

⁸⁰ To determine the type of products involved in magnet ingestion hospitalizations, this analysis excludes the 27 incidents for which there was insufficient information to categorize the type of magnet ingested.

⁸¹ There were no incidents in CPSRMS that were identified as involving science kits.

Use patterns at the time magnets were ingested also show the need to address amusement and jewelry products. The most common identified use pattern at the time of a magnet ingestion was playing, meaning the victim was playing with, fidgeting with, or orally exploring magnets at the time of ingestion. This use pattern would be expected for products intended for amusement, since they are intended for play. As Table 13 shows, in both NEISS and CPSRMS incidents, by far, playing was the most common use pattern identified,⁸² making up 70 percent (143 of 203) of the NEISS incidents, and 47 percent (61 of 129) of the CPSRMS incidents with identified use patterns. The next most common use pattern, after playing, was jewelry, meaning the magnets were being used as jewelry at the time of the incident. These made up 15 percent (31 of 203) of the NEISS incidents, and 33 percent (43 of 129) of the CPSRMS incidents with identified use patterns. The remaining identified use patterns made up fewer of the incidents. As discussed in section *IV.A.5. Uncertainties in Incident Data*, above, it is reasonable to conclude that magnet ingestions in the unidentified product type category follow this same pattern, with most involving products intended for amusement or jewelry.

Together, these factors—the prevalence of magnet ingestion incidents that involve products categorized as magnet sets, magnet toys, or jewelry; the higher rate of hospitalizations and deaths for these product categories; and the fact that the primary uses of magnets at the time of ingestion were playing and jewelry—demonstrate that magnet sets, magnet toys, and jewelry are the primary products involved in magnet ingestion incidents and pose an increased risk of serious health implications when ingested. For these reasons, CPSC considers a rule addressing these specific product categories necessary to adequately reduce the risk of injury and death

⁸² For many NEISS and CPSRMS incidents, there was insufficient information for staff to determine the use pattern at the time magnets were ingested. To identify relevant use patterns, this analysis focuses on the 203 NEISS incidents and 129 CPSRMS incidents for which staff could determine the use pattern at the time of ingestion.

associated with magnet ingestions. The definition of “subject magnets” in the proposed rule, which is limited to amusement and jewelry products, focuses the proposed rule on these most problematic products.

Developmental and Behavioral Factors. Child and teen development and behavior also support the need to address magnets intended for amusement and jewelry in the proposed rule. Small, powerful magnets, in general, are likely to appeal to children and teens. The tactile appeal, shine, color, snapping/clicking sounds when manipulated, novelty, unpredictability, and complexity of magnets appeal to children and teens. For younger children, it is developmentally normal to explore and put objects in their mouths. Incident data demonstrate this, with younger children more likely to ingest magnets intentionally (see Figures 3 and 4). Teens are at a developmental stage that involves testing limits, experimentation, bending rules, and conforming to peer pressures. Consistent with this, teens commonly ingested magnets accidentally when experimenting with them to simulate jewelry or piercings (see Figures 3 and 4). Magnets offer children and teens a seemingly safe and reversible way to try lip, tongue, cheek, and nose piercings.

CPSC staff considers products that are intended for amusement and jewelry to be more likely to be accessible to and appealing to children and teens than other magnet products. Products that are intended for amusement and jewelry are likely to be perceived by children, teens, and caregivers as appropriate for use by children and teens; that perception is likely to make them accessible and appealing to children and teens. In contrast, magnets excluded from the scope of the proposed rule (*e.g.*, home/kitchen magnets, such as hardware magnets for fastening items together, or shower curtain magnets) are likely to be part of common household products, making them less conspicuous, accessible, and appealing to children and teens, since

they are not intended for amusement or jewelry, and making caregivers less likely to give them to, purchase them for, or allow their use by children and teens.

Incident data and consumer reviews support this assessment. As the incident data indicate, for magnet ingestions in which staff could identify the product type involved, most products were magnet sets and magnet toys, neither of which are products intended for use by children under 14 years old (see Table 1 and Table 9). Despite this, the vast majority of magnet ingestion incidents involved children under 14 years old (see Table 5 and Table 12), which demonstrates that children and teens access these amusement products intended for older users. Similarly, incident data show that, where the use pattern at the time of ingestion is known, victims were, by far, most often playing with the magnet (see Table 13), suggesting that victims may be attracted to and access products that appear to be playthings. The second most common identified use pattern was jewelry (see Table 13), suggesting that children and teens are also particularly likely to interact with magnets that are part of jewelry.⁸³

Of the magnet ingestion incidents for which the source of access could be identified, 19 percent (26 of 135) involved magnets that were purchased for the victim (see Table 14), despite most incidents involving children under 14 years old and products intended for users 14 years and older. This suggests that children, teens, and caregivers perceive products like magnet sets and magnet toys to be appealing to and appropriate for children and teens.

⁸³ Incidents categorized as involving jewelry included cases in which the magnet was from a jewelry product or was described as jewelry at the time of ingestion, but the specific product could not be identified. For some of these incidents, it is possible that the magnets did not actually come from jewelry, but rather, came from other magnet products that children and teens were using as jewelry. However, staff considers most cases categorized as jewelry to have involved either jewelry or amusement products, such as magnet sets, being used as jewelry. This is because, of the cases for which staff could determine the product being used as jewelry, only one case in both the NEISS and CPSRMS datasets reported that the magnet being used as jewelry was actually a home/kitchen magnet, and none indicated the magnet was from an ASTM F963 magnet toy.

Another reason children and teens are particularly likely to be attracted by and access amusement products that include magnets is that these products often look the same as products intended as toys for children. Consumer reviews of products demonstrate this, with consumers commonly considering subject magnet products suitable playthings for children, and purchasing them for children, even when warnings state otherwise. Staff identified numerous incidents in which children ingested magnets from products that were marketed and labeled as not intended for children, and bore warnings regarding the magnet ingestion hazard. For example, staff identified 16 recent incidents in which children ingested magnets from a magnet set that included warnings and marketing indicating that the product was intended for adults. For older children, in particular, parents often do not expect that children would place magnets in their mouths.

Recalls. Recalls of magnet products further demonstrate the need to focus on magnets intended for amusement. Of the 18 recalls that involved the magnet ingestion hazard between January 1, 2010 and August 17, 2021, the vast majority involved products intended for amusement. The recalls primarily involved magnet sets and desk toys, rather than children’s toys or other non-amusement products.

e. Excluding Children’s Toys

The scope of the proposed rule specifically excludes products that are subject to 16 CFR part 1250. Currently, 16 CFR part 1250 incorporates by reference ASTM F963-17, which defines a “toy” as “any object designed, manufactured, or marketed as a plaything for children under 14 years of age.” As discussed above, ASTM F963-17 includes requirements consistent with the proposed rule, including the same performance requirements regarding size and strength.

Recall information suggests that the toy standard is largely complied with and has been effective at addressing the magnet ingestion hazard in children’s toys. As discussed in section

IV.A.5. Uncertainties in Incident Data, since the toy standard became mandatory, there has been an appreciable decline in recalls of children's toys related to the magnet ingestion hazard. Of the 18 recalls between 2010 and 2021 that involved the magnet ingestion hazard, only 4 involved children's toys, and only 2 of those were confirmed to have been noncompliant with the magnet requirements in ASTM F963. Recalls generally occur when a company receives information about a product being hazardous and reports it to CPSC. As such, the low rate of recalls involving the magnet ingestion hazard in children's toys suggests that these products largely comply with ASTM F963, and that the toy standard has been effective at addressing the magnet ingestion hazard in children's toys.

In addition, as Table 10 suggests, when ASTM F963 magnet toys are ingested, they appear to result in severe injuries less commonly than other products. Magnet ingestions of ASTM F963 magnet toys resulted in hospitalization about as often as they resulted in other non-hospitalization dispositions; in contrast, magnet toys, magnet sets, and jewelry all resulted in hospitalization far more often than they resulted in other non-hospitalization dispositions. This suggests that when ASTM F963 magnet toys are ingested, they may be less likely to result in serious health outcomes requiring hospitalization. Of the 108 CPSRMS cases that had evidence of internal interaction through body tissue, only 6 cases involved products identified as ASTM F963 magnet toys. Of the 124 CPSRMS cases that indicated surgical procedures were necessary as a result of magnet ingestion, only 9 cases involved products identified as ASTM F963 magnet toys. Most, if not all, of the ingestions of ASTM F963 magnet toys that resulted in surgical intervention did not meet the requirements of ASTM F963.

For these reasons, CPSC does not consider it necessary to further address children's toys in this proposed rule. Nevertheless, there are two elements of the definition of "toys" that are noteworthy for this proposed rule.

First, "toys" are products that are intended as "playthings." Thus, toys do not include products that are not playthings, even when they are intended for children under 14 years old. For example, children's jewelry, when not intended as a plaything, would not fall under the definition of a "toy" and, therefore, would not be subject to the toy standard.⁸⁴ As such, children's non-toy jewelry is subject to the proposed rule. Additional products may also fall under the scope of the proposed rule, although intended for users under 14 years old, if they do not constitute "playthings," but otherwise meet the definition of subject magnet products.

Second, the definition of "toys" limits them to products intended for users under 14 years old. However, as magnet ingestion incident data show, products that are intended for users 14 years and older are commonly ingested by children and teens, indicating that the toy standard, on its own, cannot adequately address the magnet ingestion hazard. As discussed above, incidents categorized as involving magnet sets or magnet toys exclude products that staff confirmed were intended as playthings for children under 14 years old. These two categories were the most common categories of identified products involved in magnet ingestion incidents, despite the fact that most incidents involved children and teens under 14 years old. As Figure 2 shows, children as young as 11 months, and many children between 1 and 13 years old ingest products in the magnet toys and magnet sets categories. Staff identified many incidents in which the product

⁸⁴ Section 1.3 of ASTM F963-17 states that the standard applies to "toys intended for use by children under 14 years of age" and section 3.1.91 defines a "toy" as "any object designed, manufactured, or marketed as a plaything for children under 14 years of age." Section 1.3.1 of ASTM F2923-20 specifies that the standard, which applies to children's jewelry, does not apply to "toy jewelry or any other products that are intended for use by a child when the child plays (that is, a necklace worn by a doll or stuffed animal; novelty jewelry with play value)" and further states that "any product which is predominately used for play value is a toy" and "toys are subject to the requirements of Consumer Safety Specification F963."

ingested was clearly marketed and labeled as intended for adults, with warnings regarding the magnet ingestion hazard, but the product was, nevertheless, ingested by children under the intended user age. In many cases, caregivers even provided these products to children, despite the warnings. This demonstrates why it is necessary to adopt a standard for products intended for users 14 years and older, in addition to the toy standard, to adequately address the magnet ingestion hazard.

f. Products Not Covered by the Proposed Rule

Based on the definition of “subject magnet products” and the scope of the proposed rule, certain products that contain loose or separable magnets are not subject to the proposed rule. Home and kitchen magnets are one such product, if they do not otherwise meet the definition of subject magnet products. Common examples of home and kitchen magnets are refrigerator magnets, magnetic decorations, hardware for kitchen cabinets, and shower curtain accessories. If such products are not loose or separable or are not designed, marketed, or intended to be used for entertainment, jewelry, mental stimulation, or stress relief, they would not fall under the scope of the proposed rule.

CPSC considers it reasonable to exclude home/kitchen products from the scope of the proposed rule for several reasons. For one, incident data indicate that home/kitchen magnets are far less commonly involved in magnet ingestion incidents than amusement and jewelry products. As Table 1 indicates, 16 percent (46 of 279) of NEISS magnet ingestion incidents for which the product category could be determined involved home/kitchen magnets; as Table 9 indicates, only 2 percent (6 of 241) of CPSRMS magnet ingestion incidents for which the product category could be determined involved home/kitchen magnets. Home/kitchen magnets also make up a very small portion of incidents that resulted in hospitalization. Table 10 shows that, only 3

percent (5 of 160) of the CSPRMS magnet ingestion incidents with identified product types that resulted in hospitalization, involved home/kitchen magnets. Of the 108 CPSRMS cases that had evidence of internal interaction through body tissue, only 1 case involved products identified by staff as home/kitchen products. Of the 124 CPSRMS cases that indicated surgical procedures were necessary as a result of magnet ingestion, only 2 cases involved products identified by staff as home/kitchen products.

In addition, as discussed above, CPSC considers it less likely that children and teens will interact with, play with, or experiment with home/kitchen magnets, particularly in ways that may lead to ingestion. Home/kitchen products excluded from the proposed rule have intended uses that do not include amusement or jewelry, and are often part of common household products, making them less conspicuous, accessible, and appealing to children and teens, since they are not intended for amusement or jewelry, and making caregivers less likely to give them to, purchase them for, or allow their use by children and teens. In contrast, the intended uses of amusement and jewelry products make them appear less hazardous, and more likely to be appealing and accessible to children and teens.

Other products that would fall outside the scope of the proposed rule include research and educational products, or those intended for commercial or industrial purposes, if they are not also intended for amusement or jewelry.⁸⁵ CPSC considers it appropriate to exclude these products for several reasons. As incident data indicate, almost no magnet ingestion incidents for which product types could be identified involved products intended for education, research, commercial, or industrial use. Among NEISS incidents, only one incident—involving a science

⁸⁵ It is also possible that products intended for purposes such as education, research, or industrial applications would not meet the definition of a “consumer product,” if they are not commonly sold to or used by consumers. If, for example, magnets for research purposes were sold through outlets primarily accessible to and used by laboratories or other research facilities, these may not be considered consumer products.

kit—potentially involved such a product; no such incidents were identified in CPSRMS data. For that one incident, little information was available about the science kit, but staff considered it possible that the product was intended for educational purposes.

Staff also considers it less likely that children or teens would have access to such products. For example, magnets used for research or industrial applications are likely to be in settings that children do not frequent. Even if children could access such products, for the same reasons as home/kitchen magnets, staff considers it less likely that these products would appeal to children, appear to be playthings or jewelry to children or caregivers, or for children to interact with them in ways that would lead to ingestion.

In addition to the likely reduced hazard these out-of-scope products present to children and teens, CPSC also seeks to limit the scope of the proposed rule to the extent possible to reduce the impact on products, such as research, education, and industrial magnet products, that may have important uses and require magnets that are small and strong to serve their function. In contrast, amusement and jewelry products likely serve less critical functions and may still serve their purpose with slightly larger or slightly weaker magnets, or non-separable magnets.

g. Other Factors Not Used in the Proposed Rule

CPSC considered using additional criteria, such as magnet composition or shape, as part of the scope of the proposed rule. However, CPSC did not limit the scope of the proposed rule to specific magnet compositions because staff has found that various magnet compositions have been involved in internal interaction incidents. For example, NIB is commonly used for smaller magnets from magnet sets and magnetic jewelry sets, and ferrite/hematite is commonly used for larger magnets, such as rock-shaped magnet toys. Staff testing of magnets in consumer products indicates that magnets with various compositions often have very high flux indexes, far in excess

of the proposed limit of less than $50 \text{ kG}^2 \text{ mm}^2$, warranting a standard for various compositions. CPSC did not include specific shapes or sizes in the scope of the proposed rule because staff found that various shapes and sizes of magnets present the hazard, including rock-shaped magnets, and most incident reports lack information about the specific shapes and sizes of the magnets. As such, the performance requirements in the proposed rule address magnets that could be ingested, regardless of their shape.

B. Performance Requirements

1. Proposed Requirements

Under the proposed rule, each loose or separable magnet in a subject magnet product that fits entirely within the small parts cylinder described in 16 CFR 1501.4 must have a flux index of less than $50 \text{ kG}^2 \text{ mm}^2$ when tested in accordance with a prescribed method. Thus, the first step is to determine whether each loose or separable magnet in a subject magnet product fits in the small parts cylinder and what its flux index is.

The small parts cylinder is described and illustrated in 16 CFR part 1501.4. Figure 5, below, shows the illustration, including the dimensions, of the cylinder, provided in the regulation.

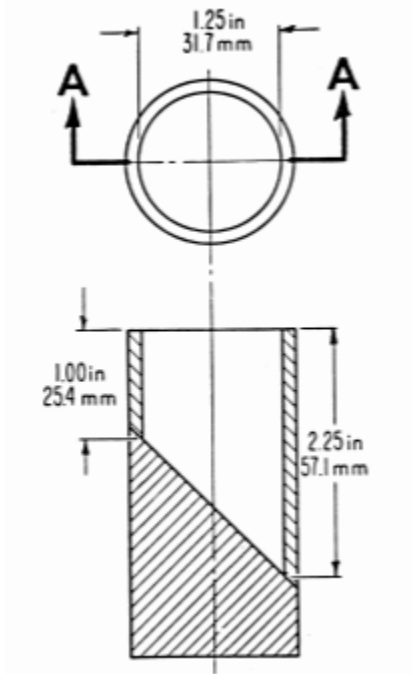

Figure 5: Small parts cylinder in 16 CFR 1501.4

If a magnet fits entirely within this cylinder, then its flux index must be less than $50 \text{ kG}^2 \text{ mm}^2$.

To determine the flux index of a magnet, the proposed rule provides that at least one loose or separable magnet of each shape and size in the subject magnet product must have its flux index determined using the procedure in sections 8.25.1 through 8.25.3 of ASTM F963-17, which specify test equipment, measurements, the test method, and the calculation for determining flux index. The test requires a direct current field gauss meter with a resolution of 5 gauss (G) capable of determining the field with an accuracy of 1.5 percent or better and an axial probe with a specified active area diameter and a distance between the active area and probe tip. Using the meter, the probe tip is placed in contact with the pole surface of the magnet, the probe is kept perpendicular to the surface, and the probe is moved across the surface to find the maximum absolute flux density. The flux index, in $\text{kG}^2 \text{ mm}^2$, is determined by multiplying the area of the pole surface (mm^2) of the magnet by the square of the maximum flux density (kG^2). The flux density must be less than $50 \text{ kG}^2 \text{ mm}^2$ to comply with the proposed rule.

2. *Basis for Proposed Requirements*

a. *Size Requirements*

The first portion of the performance requirement in the proposed rule involves determining whether a magnet fits entirely within the small parts cylinder described in 16 CFR 1501.4. The purpose of this requirement is to determine whether a magnet is small enough to be swallowed. If so, then it is subject to strength requirements to reduce the risk of internal interaction injuries from strong magnets. However, if the magnet is too large to be swallowed, as determined by the small parts cylinder, then it is not subject to any strength requirements.

The small parts cylinder was developed to address choking, aspiration, and ingestion hazards for children, and was largely based on research and data regarding the size of objects children ingest. To address this hazard, since 1980, the Commission's regulations (at 16 CFR part 1501) have specified that certain toys and other articles intended for use by children must not contain choking, aspiration, or ingestion hazards for children. Whether these products present such hazards is determined by whether they fit within the small parts cylinder described in 16 CFR 1501.4.⁸⁶ Several ASTM standards for children's products reference these regulations as well, requiring that products have no small parts as determined by 16 CFR part 1501,⁸⁷ and the small parts cylinder specified in the ASTM standards that addresses magnet ingestions is the same as in 16 CFR 1501.4. Similarly, the small parts cylinders referenced in international standards that address magnet ingestions, including EN 71-1: 2014 and ISO 8124-1: 2018, are also the same as in 16 CFR 1501.4. These standards are developed by consensus of various groups, including consumer groups, children's product engineers and experts, and manufacturers of children's products. As such, the small parts cylinder in 16 CFR 1501.4 is consistent with

⁸⁶ See 43 Fed. Reg. 47684 (Oct. 16, 1978); 44 Fed. Reg. 34892 (June 15, 1979).

⁸⁷ For example, ASTM F2088-20, *Standard Consumer Safety Specification for Infant and Cradle Swings*.

consensus standards developed with cooperation and input from various experts, is widely recognized, and has long been used as a way to identify products that children can ingest.

Incident data further support the effectiveness of the small parts cylinder in 16 CFR part 1501.4 to address the magnet ingestion hazard. As discussed above, magnet ingestion incidents substantially declined during the years the magnet sets rule was announced and in effect, and substantially increased after the rule was vacated. The magnet sets rule included the same performance requirements regarding size and strength as this proposed rule, including the small parts cylinder. The marked decline in magnet ingestions during that rule suggests that the performance requirements in that rule were effective at reducing the risk of children ingesting magnets.

Similarly, there was a significant decline in recalls involving the magnet ingestion hazard after the toy standard became mandatory. The toy standard requires compliance with ASTM F963, which includes the same small parts cylinder as 16 CFR 1501.4. As such, this decline in recalled toys that present a magnet ingestion hazard after the toy standard became mandatory suggests that the requirements in that rule were effective at reducing the risk of children ingesting magnets. The low number of magnet ingestion incidents that identify ASTM F963 magnet toys as the involved product also indicates that the requirements in the standard have been effective at addressing the magnet ingestion hazard. Moreover, when magnet ingestions did occur with children's toys, they rarely resulted in the internal interaction hazard, and those that did result in internal interaction, did not comply with the toy standard.

For these reasons, the proposed rule uses 16 CFR 1501.4 as the means of determining whether a child could ingest a particular magnet, thereby subjecting it to performance requirements regarding strength, to reduce the risk of injury.

b. Strength Requirements

When a magnet is small enough to fit entirely within the small parts cylinder, the proposed rule requires that the magnet have a flux index less than $50 \text{ kG}^2 \text{ mm}^2$. This provision consists of two elements—a method for determining flux index, and a flux index limit of less than $50 \text{ kG}^2 \text{ mm}^2$. This requirement is intended to reduce the risk that a magnet is strong enough to cause internal interaction injuries, if ingested. This section discusses the rationale for both the flux index methodology and the flux index limit in the proposed rule.

Flux Index Methodology. The proposed rule incorporates by reference the provisions in ASTM F963 that specify the method for measuring and calculating flux index. The ASTM Subcommittee F15.22 on Toy Safety developed this methodology and ASTM first published it in ASTM F963-07. The magnetic flux index estimates the magnet attraction force of individual single-pole magnets.

A magnet's composition, mass, and shape determine its magnetic field. This field is aligned with its north and south magnetic poles (see Figure 6). Surface flux density is a measurement of the magnetic field intensity at a given perpendicular distance above an area (dimension "x" in Figure 6). The maximum flux density is measured perpendicular to the pole surface of a magnet.

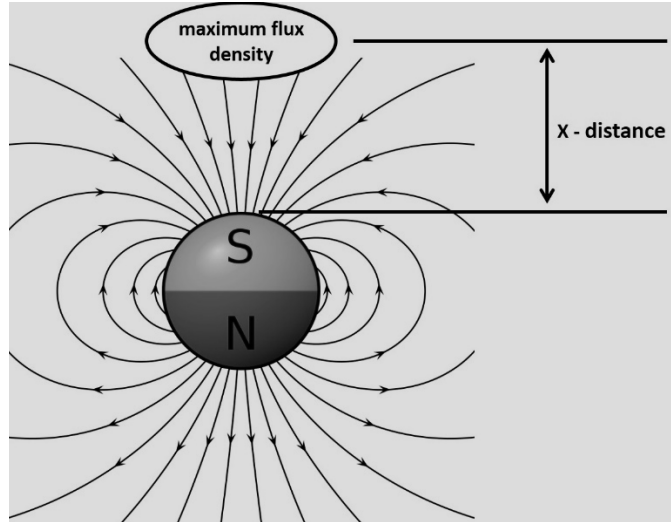

Figure 6: Magnetic field of spherical magnet.

The ASTM F963 working group that developed the flux index methodology aimed to address injuries involving children ingesting small, powerful magnets. As such, it was designed to address the same hazard at issue in this proposed rule, and minimize the risk of internal injuries when magnets are ingested. As part of an ASTM standard, this methodology was developed by consensus, with input from various stakeholders, such as children’s product manufacturers, consumer groups, and children’s product engineers and experts. In addition, this methodology is used in multiple ASTM standards that address the magnet ingestion hazard, international standards (including EN 71-1: 2014 and ISO 8124-1: 2018), and the mandatory toy standard in 16 CFR part 1250. As part of these standards, the methodology is widely recognized and accepted, and has been used for many years.

CPSC staff considers this methodology effective for assessing the strength of subject magnet products. Incident data also support the effectiveness of the flux index methodology in ASTM F963 to address the magnet ingestion hazard. Magnet ingestion incidents appreciably declined during the years the magnet sets rule was announced and in effect, and appreciably increased after the rule was vacated. The magnet sets rule included the same size and strength

limits as this proposed rule, and incorporated by reference the flux index methodology in ASTM F963. The decline in magnet ingestions during that rule suggests that the performance requirements in that rule were effective at reducing the risk of injury and death associated with magnet ingestions. Similarly, there was a significant decline in recalls involving the magnet ingestion hazard after the toy standard became mandatory. The toy standard requires compliance with ASTM F963 and, therefore, includes the same flux index methodology as this proposed rule. The decline in recalled toys that present a magnet ingestion hazard after the toy standard became mandatory suggests that the requirements in that rule were effective at reducing the risk of injury and death associated with magnet ingestions. The low number of magnet ingestion incidents that identify ASTM F963 magnet toys as the involved product also indicates that the requirements in the standard have been effective at reducing the magnet ingestion hazard. When magnet ingestions did occur with children's toys, they rarely resulted in the internal interaction hazard, and those that did result in internal interaction, did not comply with the toy standard.

For these reasons, the proposed rule uses the flux index methodology in ASTM F963-17 as the means of measuring the strength of magnets for purposes of limiting the risk of internal interaction injuries when ingested.

There are two issues that the Commission seeks input on regarding the flux index methodology. The first issue involves how many magnets to test. The proposed rule and ASTM F963-17 do not explicitly state how many magnets from a product to test, or whether to use statistical sampling. The proposed rule requires at least one loose or separable magnet of each shape and size to be tested, and specifies that each loose or separable magnet in a subject magnet product that fits entirely within the small parts cylinder must have a flux index less than $50 \text{ kG}^2 \text{ mm}^2$. Similarly, section 4.38.1 of ASTM F963-17 states that "toys shall not contain a loose as-

received hazardous magnet or a loose as-received hazardous magnetic component.” These provisions indicate that each magnet may need to be tested to ensure that compliance with the size and strength provisions.

However, subject magnet products may consist of hundreds or thousands of individual magnets. As such, it may be reasonable to require that only a “representative sample” or “at least one representative sample of each shape and size” be tested. CPSC staff’s testing of magnets, described below, suggests that individual magnets within the same product may have different flux indexes, which may suggest that it is important to test each individual magnet in a product. CPSC seeks comments on how firms would test products to align with the proposed requirements, whether another requirement regarding the number of magnets to test is appropriate, and how firms would satisfy such alternative requirements.

The second issue for which the Commission seeks comments is the utility of the flux index methodology for certain magnets—in particular, small spherical magnets. Staff has found the flux index methodology straightforward and consistent when used for large disc magnets. However, staff encountered some challenges finding the location of the poles for magnets smaller than 3 mm in diameter because of difficulties handling these particularly small spherical magnets. This may result in inaccurate measurements of the highest flux index values if the value is not measured above the magnet’s pole. Staff testing of 2.5 mm spherical magnets, described below, illustrates this potential issue.

To examine possible ways to address this, staff refined the test procedure in ASTM F963-17 to include additional detail to locate the magnet pole and secure the magnet on a base, rather than holding it. This test procedure maintained the flux index methodology in ASTM F963-17, and merely added information to it, which staff found improved the accuracy and consistency of

flux density measurements and calculations. This refined procedure is provided in detail in the Appendix to Tab D of the NPR briefing package. To summarize, the refined test method consists of the following steps:

- 1) Use a flat magnetic or ferromagnetic utensil to attract spherical magnets into alignment with pole orientation towards the utensil;
- 2) Transfer the spherical magnets from the utensil to a flat surface covered in at least 2 mm depth of putty that is dense/thick enough to maintain the configuration of the spherical magnets in the proper pole orientation (established by magnetic attraction with the utensil); and
- 3) With the spherical magnets aligned in the flat surface putty with pole orientation facing away from the test surface, use the gauss meter probe to determine the maximum flux value of each individual magnet.

The additional detail in this refined procedure is one option for potentially supplementing the flux index methodology in ASTM F963-17. However, there are other potential alternatives to the method in ASTM F963-17, such as considering attraction and repulsion forces. The Commission requests comments on the variability of flux index results, issues determining the flux index of smaller magnets, and potential refinements or alternatives to the proposed methodology for assessing the strength of magnets.

Flux Index Limit. The proposed rule limits the flux index of magnets small enough to be swallowed to less than $50 \text{ kG}^2 \text{ mm}^2$. ASTM introduced this flux index limit in 2007, in ASTM F963-07.⁸⁸ ASTM set the flux index limit at $50 \text{ kG}^2 \text{ mm}^2$ based on measurements of flux indexes

⁸⁸ ASTM F963-2007 specified that prohibited hazardous magnets had a flux index greater than $50 \text{ kG}^2 \text{ mm}^2$, however, this was revised in later versions of the standard, and ASTM F963-17 now prohibits hazardous magnets with a flux index of $50 \text{ kG}^2 \text{ mm}^2$ or more,

in magnetic toys that were involved in magnet ingestion incidents at the time, which generally had flux index measurements over $70 \text{ kG}^2 \text{ mm}^2$. Based on this information, $70 \text{ kG}^2 \text{ mm}^2$ was determined to be an unsafe flux index measurement, and ASTM set the limit at $50 \text{ kG}^2 \text{ mm}^2$ to provide a factor of safety.

As part of an ASTM standard, the flux index limit was developed by consensus of various groups, including consumer groups, children's product engineers and experts, and manufacturers of children's products. Additional ASTM standards, as well as international standards that address magnet ingestions, including EN 71-1: 2014 and ISO 8124-1: 2018, also include a flux index limit of $50 \text{ kG}^2 \text{ mm}^2$ for ingestible magnets. As such, the flux index limit of $50 \text{ kG}^2 \text{ mm}^2$ is consistent with consensus standards developed with cooperation and input from various experts, is widely recognized, and has long been used as a way to reduce the internal interaction hazard when magnets are ingested.

Incident data support the effectiveness of this flux index limit to address the magnet ingestion hazard. Magnet ingestion incidents substantially declined during the years the magnet sets rule was announced and in effect, and substantially increased after the rule was vacated. The magnet sets rule included a flux index limit of $50 \text{ kG}^2 \text{ mm}^2$ for ingestible magnets. The marked decline in magnet ingestions during that rule suggests that the performance requirements in that rule were effective at reducing the risk of injury and death associated with magnet ingestions. Similarly, there was a significant decline in recalls involving the magnet ingestion hazard after the toy standard became mandatory. The toy standard requires compliance with ASTM F963 and, therefore, includes the same $50 \text{ kG}^2 \text{ mm}^2$ limit for ingestible magnets as the proposed rule. This decline in recalled toys for magnet ingestion hazards suggests that the requirements in that rule were effective at reducing the risk of injury and death associated with magnet ingestions.

The low number of magnet ingestion incidents that identify ASTM F963 magnet toys as the involved product also indicate that the requirements in that standard have been effective at addressing the magnet ingestion hazard. Moreover, when magnet ingestions did occur with children's toys, they rarely resulted in internal interaction, and those that did result in internal interaction, did not comply with the toy standard.

Staff's assessment of the flux index of subject magnet products, including those involved in magnet ingestion incidents, and those known to have involved internal interaction injuries, indicates that subject magnet products have a wide range of flux indexes. The most common subject magnet products staff identified are 3 to 6 mm and have flux indexes of 300 to 400 $\text{kG}^2 \text{mm}^2$. However, staff's testing of smaller 2.5 mm magnets, some of which resulted in internal interaction injuries when ingested, yielded flux indexes close to 50 $\text{kG}^2 \text{mm}^2$. CPSC expects that, in order to comply with the proposed rule, firms will use magnets with flux indexes sufficiently lower than 50 $\text{kG}^2 \text{mm}^2$ in subject magnet products, to account for manufacturing and testing variances/tolerances, which may result in subject magnet products having flux indexes even lower than required by the rule.

Based on the widespread and longstanding use of the flux index limit of 50 $\text{kG}^2 \text{mm}^2$, its development and acceptance by multiple stakeholders, the effectiveness of standards that have used this limit to address magnet ingestion incidents, and staff testing showing that magnets involved in internal interaction incidents had flux indexes close to 50 $\text{kG}^2 \text{mm}^2$, the Commission proposes to require that magnets that are small enough to ingest have a flux index of less than 50 $\text{kG}^2 \text{mm}^2$.

However, the Commission seeks comments on this flux index limit, whether a lower limit may be appropriate, and seeks testing and safety data supporting an appropriate flux index limit.

CPSC testing of a small sample of subject magnet products suggests that magnets with a flux index lower than (*i.e.*, weaker than) $50 \text{ kG}^2 \text{ mm}^2$ may be capable of causing internal interaction injuries, indicating that a flux index limit lower than $50 \text{ kG}^2 \text{ mm}^2$ may be appropriate to address the internal interaction hazard; however, this testing did not provide conclusive evidence that magnets weaker than $50 \text{ kG}^2 \text{ mm}^2$ present an internal interaction hazard. This testing is described below.

CPSC Testing. To gather information about the flux index methodology, flux index limit, and what flux index can interact internally through body tissue, staff conducted testing on a small number of magnets. Staff tested magnets with diameters smaller than 5 mm because they generally had lower flux indexes than larger magnets, and because these smaller magnets presented the testing challenges described above. Staff used the test method in ASTM F963-17 with the additions described in the Appendix to Tab D of the NPR briefing package. This testing involved only a small number of samples, and a limited variety of products, sizes, and shapes. As such, while this testing is informative and raises potential issues, the broader significance of these results is limited.

In March, April, and June 2021, CPSC staff tested magnets with diameters smaller than 5 mm, including 2.5 mm diameter spherical magnets from nine exemplar samples of one brand of magnet set, and two incident samples of the same brand.⁸⁹ Additionally, staff tested 3 mm diameter spherical magnets from two incident samples from unknown manufacturers. Staff selected these samples because of their involvement in internal interaction incidents. CPSC is aware of 16 ingestion incidents and one nasal insertion incident involving the 2.5 mm diameter

⁸⁹ Exemplar refers to products that are the same model and brand as those involved in the incident, but not the actual product involved in the incident. Incident samples refer to the actual products involved in an incident.

spherical magnets that staff tested.⁹⁰ These 17 incidents resulted in at least 10 surgeries (such as appendectomy and bowel resection) and six instances of internal interaction through body tissue. The nasal insertion incident involved two 2.5 mm diameter spherical magnets attracting through and perforating the victim's nasal septum, which is tissue thicker than the GI walls.

In March 2021, staff conducted inter-rater reliability testing (*i.e.*, the extent to which 2 or more observations agree) in which 3 staff members tested the same 21 exemplar 2.5 mm diameter spherical magnets. Three magnets were tested from each of 7 sets/samples of the same magnet set brand. Staff chose 3 magnets from each set to analyze intra-set variability in magnetic flux index. Table 15 shows the results of this testing.

Table 15: Inter-rater Reliability Test Measurements of 2.5 mm Spherical Magnets (March 2021)

Test Set	Magnet 1 (kG ² mm ²)			Magnet 2 (kG ² mm ²)			Magnet 3 (kG ² mm ²)		
	Tester 1	Tester 2	Tester 3	Tester 1	Tester 2	Tester 3	Tester 1	Tester 2	Tester 3
1	53.788	56.294	42.730	48.950	50.797	47.197	50.797	53.246	50.462
2	59.477	60.876	53.926	52.055	54.175	40.755	53.372	56.197	74.308
3	29.021	29.627	28.191	29.205	30.752	27.507	39.152	41.192	35.507
4	33.226	33.932	31.232	51.627	54.623	36.160	53.605	53.705	42.825
5	42.940	41.681	46.425	52.600	51.631	48.106	46.501	48.576	44.031
6	34.381	34.838	34.217	40.974	40.279	39.920	35.085	36.197	33.905
7	55.118	56.522	53.955	56.819	57.577	56.230	40.890	34.274	39.933

These results suggest several points of interest. For one, they indicate that there was some variation in flux index results across testers. In addition, these results suggest that magnets from the same set tend to have more similar flux index measurements than magnets from different sets of the same product. The results also suggest that there is variation in the flux indexes of magnets from the same set, and the same products (across sets). The flux index measurements of 21

⁹⁰ Many of these cases occurred after the NEISS and CPSRMS data extraction used for the NPR briefing package and, therefore, are not captured in those datasets.

exemplar 2.5 mm diameter spherical magnets from 7 different magnet sets of the same brand ranged from 27.507 to 74.308 kG² mm². This variation in flux indexes, potentially due to manufacturing variation and testing variation, may necessitate that firms use magnets with flux indexes sufficiently lower than 50 kG² mm² in subject magnet products, to account for this potential variation in flux index results.

This variation also may have implications for the number of magnets in a product that should be tested to assess flux index. Under the proposed rule, one loose or separable magnet with a flux index of 50 kG² mm² or more in a subject magnet product makes the whole product violative. However, this above testing suggests that this determination may be affected by the number or sample of magnets tested from a product because a product that includes multiple magnets may contain some magnets that meet and some that exceed the flux index limit. Thus, this testing may have implications for how many magnets from a product should be tested (*e.g.*, all magnets in the product, a representative sample of magnets in the product).

In addition, because this testing used exemplars, and not the magnets that were actually ingested, staff cannot determine what flux index measurements resulted in internal interaction injuries. However, these results suggest that magnets ranging from approximately 30 to 70 kG² mm² could have resulted in internal interaction injuries. If the actual magnets involved in the incident had flux indexes of 50 kG² mm² or more, the proposed rule would address these injuries; if the actual magnets involved in the incident had flux indexes closer to 30 to 40 kG² mm², the proposed rule may not address these injuries.

In March and April 2021, staff conducted similar testing. Three staff members tested spherical magnets from 4 separate sample/sets that were involved in internal interaction incidents. Set 1 included a single 2.5 mm diameter magnet that had not been ingested, but was

from a set of ingested magnets that had interacted internally through a victim's body tissue. The remaining 3 sets had magnets that were ingested and removed from the intestines of the victim who swallowed them (*i.e.*, interacted internally through victims' body tissue). Staff tested 3 magnets from each of these 3 sets; 2 of the 3 sets were composed of 3 mm diameter magnets and 1 set was composed of 2.5 mm diameter magnets. The results are provided in Table 16.

Table 16: Test Measurements of 2.5 mm and 3 mm Spherical Magnet Sets Involved in Ingestion Incidents

Set	Magnet 1 (kG ² mm ²)			Magnet 2 (kG ² mm ²)			Magnet 3 (kG ² mm ²)		
	Tester 1	Tester 2	Tester 3	Tester 1	Tester 2	Tester 3	Tester 1	Tester 2	Tester 3
1	42.020	45.173	41.766	N/A	N/A	N/A	N/A	N/A	N/A
2	76.919	82.469	65.959	72.911	70.882	63.795	70.206	68.475	63.843
3	46.239	48.513	46.384	47.536	49.427	47.991	48.309	52.135	48.749
4	93.979	96.426	89.349	90.240	96.383	88.218	89.070	94.970	95.712

The results in Table 16 show similar trends as the testing above, with there being some variation across testers, less variation within sets than across sets, and a range of flux indexes across magnets, and sets. Set 1 in Table 16 was the same brand as the sets shown in Table 15, was a 2.5 mm spherical magnet, and had flux indexes that ranged from 41.766 to 45.173 kG² mm². Although this magnet was from a set that was ingested and interacted internally through body tissue, this exact magnet was not ingested, so staff cannot determine the flux index of the magnets that were ingested, but it is possible that the magnets that interacted through body tissue were also in this range, with flux indexes less than 50 kG² mm².

Sets 2 and 4 in Table 16 were 3 mm diameter spherical magnets from 2 sets from unknown manufacturers. The magnets staff tested for these sets were actually ingested and had interacted internally through a victim's body tissue. As such, the results for these sets are particularly useful for assessing the magnet strength that may attract internally through body tissue. These magnets had flux indexes that ranged from 63.795 to 96.426 kG² mm². Thus, the

limit of $50 \text{ kG}^2 \text{ mm}^2$ in the proposed rule would address the magnet interaction hazard these magnets presented, with a factor of safety to account for potential variation in results across testers, manufacturing variation, and variation due to the challenges of testing small spherical magnets.

Set 3 in Table 16 included three 2.5 mm diameter spherical magnets from a magnet set of the same brand as those in Table 15. The tested magnets had been ingested and interacted internally through the victim's tissue. Thus, like sets 2 and 4, these results are particularly useful for assessing the magnet strength that may attract internally through body tissue. The flux indexes for these magnets ranged from 46.239 to 52.135 $\text{kG}^2 \text{ mm}^2$. Using only Tester 1 or Tester 3's results, these magnets would comply with the proposed rule because these testers found flux indexes less than $50 \text{ kG}^2 \text{ mm}^2$ for all 3 magnets. Using Tester 2's results, these magnets would not comply with the proposed rule because magnet 3 in the set had a flux index of more than $50 \text{ kG}^2 \text{ mm}^2$. Because, depending on the tester, this set may comply with the proposed rule but interacted internally through body tissue, these results raise the question whether a lower flux index limit may be appropriate. However, even with a flux index limit of $50 \text{ kG}^2 \text{ mm}^2$, it is possible that the proposed rule would address the incident involving these magnets because the flux indexes for this set were very close to $50 \text{ kG}^2 \text{ mm}^2$. To comply with the proposed rule, firms may build in a factor of safety to ensure their magnets are not close to $50 \text{ kG}^2 \text{ mm}^2$, to account for variation in test results and testers and ensure their products will comply with the standard.

In June 2021, CPSC staff tested magnets from 2 more exemplar magnet sets of the same brand shown in Table 15, each of which consisted of spherical rare-earth magnets that were 2.5 mm in diameter. Magnet sets of this brand and type were known to have been involved in at least

6 internal interaction incidents. Staff measured the flux index of 3 magnets from each set and calculated the flux index values. The results are in Table 17.

Table 17: Test Measurements of Two 2.5 mm Diameter Magnet Sets (June 2021)

Sample Magnet Set 1						Sample Magnet Set 2				
Magnet	Max Flux (kG)	Max Flux ² (kG ²)	Diameter (mm)	Area (mm ²)	Flux Index	Max Flux (kG)	Max Flux ² (kG ²)	Diameter (mm)	Area (mm ²)	Flux Index
1	2.812	7.907	2.520	4.985	39.417	3.343	11.174	2.520	4.985	55.705
2	2.714	7.363	2.550	5.104	37.585	3.450	11.903	2.590	5.266	62.677
3	2.798	7.826	2.410	4.559	35.683	3.275	10.726	2.530	5.025	53.896

Again, these results indicate variation in the flux indexes of magnets within the same set, and that flux indexes are more similar within a set than across sets. For the 6 magnets tested, flux indexes ranged from 35.683 to 62.677 kG² mm².

The following provides a summary of the consolidated results of all of these tests. Staff assessed 2.5 mm and 3 mm diameter spherical magnets associated with internal interaction incidents. The exemplar 2.5 mm magnets had flux index values between 27.507 to 74.308 kG² mm². Incident samples with magnets involved in internal interaction injuries had flux index values between 46.239 and 52.135 kG² mm² for the 2.5 mm magnets, and 63.795 to 96.426 kG² mm² for the 3 mm diameter magnets. In general, these results suggest that the proposed rule would address the internal interaction hazard associated with magnet ingestions because many of the sets tested would not comply with the proposed rule because at least one of the tested magnets had a flux index of 50 kG² mm² or more. For the reasons described above, staff considers the flux index methodology and limit in the proposed rule to be appropriate to adequately address the magnet ingestion hazard.

However, these results also suggest that there is some variability in the flux index values, which may have implications for the proposed flux index test methodology. These results also

indicate that magnets that may have flux indexes lower than 50 kG² mm² may have caused internal interaction injuries, suggesting that a lower flux index limit than 50 kG² mm² may be appropriate; however, the results are inconclusive because staff could not identify, with certainty, the flux indexes of magnets that actually caused internal interaction injuries. In addition, staff notes the limited scope of this testing, including the small sample size, and limited variety of products tested. The Commission seeks comments on the proposed requirements regarding flux index methodology and limits, including information about whether flux indexes below 50 kG² mm² present an internal interaction hazard.

VII. Preliminary Regulatory Analysis⁹¹

The Commission is proposing to issue a rule under sections 7 and 9 of the CPSA. The CPSA requires that the Commission prepare a preliminary regulatory analysis and publish it with the text of the proposed rule. 15 U.S.C. 2058(c). The following discussion is extracted from staff's memorandum, "Preliminary Regulatory Analysis of a Draft Proposed Rule that Would Establish a Standard for Hazardous Magnet Products," available in Tab E of the NPR briefing package.

A. Preliminary Description of Potential Costs and Benefits of the Proposed Rule

The preliminary regulatory analysis must include a description of the potential benefits and costs of the proposed rule. The benefits of the rule are measured as the expected reduction in the societal costs of deaths and injuries that would result from adopting the proposed rule and any benefits that cannot be quantified. The costs of the rule consist of the added costs associated with modifying or discontinuing products that do not comply with the requirements of the rule,

⁹¹ Further detail regarding the preliminary regulatory analysis is available in Tab E of the NPR briefing package.

including any impacts on the utility of the products for consumers, as well as any costs that cannot be quantified.

1. Deaths and Injuries Related to Magnet Ingestions

As discussed above, based on NEISS data, which is a nationally representative probability sample of about 100 U.S. hospitals, there were an estimated 4,400 ED-treated magnet ingestions between 2010 and 2020 that involved subject magnet products, and an additional estimated 18,100 ED-treated magnet ingestions that involved unidentified magnet products, of which CPSC concludes a large portion involved subject magnet products.

In addition to injuries initially treated in hospital EDs, many product-related injuries are treated in other medical settings, such as, physicians' offices, clinics, and ambulatory surgery centers. Some injuries also result in direct hospital admissions, bypassing hospital EDs entirely. CPSC estimates the number of subject magnet product injuries treated outside of hospital EDs with CPSC's Injury Cost Model (ICM), which uses empirical relationships between the characteristics of injuries (diagnosis and body part) and victims (age and sex) initially treated in hospital EDs and the characteristics of those initially treated in other settings.⁹²

The ICM estimate of injuries treated outside of hospitals or hospital EDs (*e.g.*, in doctors' offices, clinics) is based on data from the Medical Expenditure Panel Survey (MEPS). The MEPS is a nationally representative survey of the civilian, non-institutionalized population that quantifies individuals' use of health services and corresponding medical expenditures. It

⁹² A detailed discussion of the ICM and these methods is in: Miller, T.R., Lawrence, B.A., Jensen, A.F., Waehrer, G.M., Spicer, R.S., Lestina, D.C., and Cohen, M.A., *The Consumer Product Safety Commission's Revised Injury Cost Model*, Calverton, MD: Public Services Research Institute (2000); Bhattacharya, S., Lawrence, B., Miller, T., Zaloshnja, E., Jones, P., *Ratios for Computing Medical Treated Injury Incidence and Its Standard Error from NEISS Data* (Contract CPSC-D-05-0006, Task Order 8), Calverton, MD: Pacific Institute for Research and Evaluation (2012); and Lawrence, B.A., *Revised Incidence Estimates for Nonfatal, Non-Hospitalized Consumer Product Injuries Treated Outside Emergency Departments* (Contract CPSC-D-89-09-0003, Task Order 2), Calverton, MD: Pacific Institute for Research and Evaluation (2013).

combines data from a panel of participants interviewed quarterly over a two-year period with data from the respondents' medical providers. The MEPS is administered by the Agency for Healthcare Research and Quality (AHRQ). The ICM uses the MEPS data, in combination with a classification tree analysis technique, to project the number and characteristics of injuries treated outside of hospitals. To project the number of direct hospital admissions that bypass hospital EDs, the ICM uses data from the Nationwide Inpatient Sample of the Healthcare Cost and Utilization Project (HCUP-NIS), which was also analyzed using a classification tree analysis technique. HCUP is a family of healthcare databases and related software tools and products developed through a federal-state-industry partnership and sponsored by AHRQ. The HCUP-NIS provides information annually on approximately 3 to 4 million in-patient stays from about 1,000 hospitals.

The classification tree analysis technique (also called decision tree) is a statistical tool that divides and sorts data into smaller and smaller groups for estimating the ED share of injuries until no further gains in predictive power can be obtained. This technique allows for more precise estimates of injuries treated in doctor visits or injuries admitted directly to the hospital than other regression techniques. For example, where data permit, the age and sex of the victim can have an influence on the estimates of the number of injuries treated outside the ED. Combining the national estimates of NEISS with the non-ED estimates from the ICM using classification tree techniques provides total estimated medically-treated injuries.

Based on the estimate of 2,135 magnet injuries initially treated in hospital EDs annually during 2017 through 2020, the ICM projects that another 856 magnet injuries were treated annually outside of hospitals (*e.g.*, in doctors' offices, clinics) and that there were about 264 direct hospital admissions annually, bypassing the ED. Thus, combined with the ED-treated

injuries, staff estimates that there were a total of 3,255 medically treated injuries annually involving subject magnets products from 2017 through 2020.

2. Societal Costs of Deaths and Injuries

The ICM is fully integrated with NEISS and provides estimates of the societal costs of injuries reported through NEISS, as well as the societal costs of other medically treated injuries estimated by the ICM. The major aggregated societal cost components provided by the ICM include medical costs, work losses, and the intangible costs associated with lost quality of life or pain and suffering.

Medical costs include three categories of expenditures: (1) medical and hospital costs associated with treating the injury victim during the initial recovery period and in the long term, including the costs associated with corrective surgery, the treatment of chronic injuries, and rehabilitation services; (2) ancillary costs, such as costs for prescriptions, medical equipment, and ambulance transport; and (3) costs of health insurance claims processing. CPSC derived the cost estimates for these expenditure categories from a number of national and state databases, including MEPS, HCUP-NIS, the Nationwide Emergency Department Sample (NEDS), the National Nursing Home Survey (NNHS), MarketScan® claims data, and a variety of other federal, state, and private databases.

Work loss estimates are intended to include: (1) the forgone earnings of the victim, including lost wage work and household work; (2) the forgone earnings of parents and visitors, including lost wage work and household work; (3) imputed long term work losses of the victim that would be associated with permanent impairment; and (4) employer productivity losses, such as the costs incurred when employers spend time juggling schedules or training replacement workers. Estimates are based on information from HCUP-NIS, NEDS, Detailed Claims

Information (a workers' compensation database), the National Health Interview Survey, U.S. Bureau of Labor Statistics, and other sources. The intangible, or non-economic, costs of injury reflect the physical and emotional trauma of injury, as well as the mental anguish of victims and caregivers. Intangible costs are difficult to quantify because they do not represent products or resources traded in the marketplace. Nevertheless, they typically represent the largest component of injury cost and need to be accounted for in any benefit-cost analysis involving health outcomes. The ICM develops a monetary estimate of these intangible costs from jury awards for pain and suffering. While these awards can vary widely on a case-by-case basis, studies have shown them to be systematically related to a number of factors, including economic losses, the type and severity of injury, and the age of the victim.⁹³ CPSC derived estimates for the ICM from regression analysis of jury awards in nonfatal product liability cases involving consumer products compiled by Jury Verdicts Research, Inc.

Table 18 provides annual estimates of the injuries and societal costs associated with ingestions of magnets categorized as magnet sets, magnet toys, and jewelry.

⁹³ W. Kip Viscusi (1988), *The determinants of the disposition of product liability cases: Systematic compensation or capricious awards?*, International Review of Law and Economics, 8, 203-220; Gregory B. Rodgers (1993), *Estimating jury compensation for pain and suffering in product liability cases involving nonfatal personal injury*, Journal of Forensic Economics 6(3), 251-262; and Mark A. Cohen and Ted R. Miller (2003), *"Willingness to award" nonmonetary damages and implied value of life from jury awards*, International Journal of Law and Economics, 23, 165-184.

Table 18: Estimated average annual medically treated injuries and associated societal costs for ingestions of products categorized as magnet sets, magnet toys, and jewelry, for 2017 through 2020.

Injury Disposition	Estimated Number	Estimated Societal Costs (\$ millions)*
Doctor/Clinic	164	\$2.2
Treated and Released from Hospital ED	278	\$6.2
Admitted to Hospital through ED (NEISS)	159†	\$26.4
Direct Hospital Admissions, Bypassing	77	\$12.8
Total Medically Attended Injuries	678	\$47.6

* In 2018 dollars.

† This estimate may not be reliable because of the small number of cases on which it is based.

The 2017 through 2020 NEISS estimates suggest an estimated annual average of about 437 ED-treated injuries, comprised of 278 injuries that were treated and released and 159 injuries that required hospitalization. Additionally, based on estimates from the ICM, 164 injuries were treated outside of hospitals annually and another 77 injuries resulted in direct hospital admission.

Based on ICM estimates, these injuries resulted in annual societal costs of about \$47.6 million (in 2018 dollars) during 2017 through 2020. The average estimated societal cost per injury was about \$13,000 for injuries treated in physician’s offices, clinics, and other non-hospital settings; about \$22,000 for injuries to victims who were treated and released from EDs; and about \$166,000 for injuries that required admission to the hospital for treatment. Medical costs and work losses (including work losses of caregivers) accounted for about 44 percent of these injury cost estimates, and the less tangible costs of injury associated with pain and suffering accounted for about 56 percent of the estimated injury costs.

Table 18 reflects magnet ingestion incidents that involved products categorized as magnet sets, magnet toys, and jewelry—it does not include incidents categorized as involving unidentified product types. However, as discussed in section *IV.A.5. Uncertainties in Incident*

Data, above, most of the incidents in this unidentified product type category likely involved subject magnet products. Thus, in addition to the magnet ingestion incidents upon which Table 15 was based, there were 322 NEISS cases during 2017 through 2020 (representing about 1,873 ED-treated injuries annually) in the unidentified product type category. Based on ICM estimates for unidentified product types involved in magnet ingestion injuries, average annual societal costs for 2017-2020 totaled \$151.8 million. Consequently, to the extent that the unidentified magnet products were products that would be covered by the proposed rule, Table 18 could substantially understate the societal costs associated with the ingestion of subject magnet products.

3. Potential Benefits of Proposed Rule

The benefits of the proposed rule would be the reduction in the risk of injury and death from magnet ingestions and the resulting value of the societal costs of the injuries that the rule would prevent. In addition to the injuries reflected in the analysis above, staff is aware of 5 fatalities in the United States resulting from magnet ingestions. Thus, the rule would reduce the likelihood of future fatalities as well as injuries.

The annual expected benefits of the rule depend on the exposure to risk associated with subject magnet products, as well as the estimated societal costs described in Table 18, above. Although subject magnet products may retain their magnetism for many years, it is likely that some are discarded well before that time. Thus, the actual expected product life of subject magnet products is uncertain; this analysis presents a range of potential benefit estimates under an assumed product life of 1.5, 2, and 3 years. Table 19 presents benefit estimates under the alternative product life assumptions (line (b)).

Table 19: Present Value of Societal Costs Per Subject Magnet Product in Use (or Gross Benefits of a Rule), for Three Expected Product Lives from 2017 through 2020.

(a) Aggregate Annual Societal Costs (millions \$)	\$47.6	\$47.6	\$47.6
(b) Expected Useful Product Life (years)	1.5	2	3
(c) Magnet Products in Use, Average Annual	444,000	545,000	701,000
(d) Annual Societal Costs per Subject Magnet Product [(a) ÷ (c)]	\$107	\$87	\$68
(e) Present Value of Societal Costs, per Subject Magnet Product (3% Discount Rate)	\$160	\$171	\$190
(f) Present Value of Societal Costs, per Subject Magnet Product (7% Discount Rate)	\$154	\$162	\$178

In Table 19, line (a) shows the average annual aggregate societal costs from Table 18. Line (c) presents the average annual estimated number of subject magnet products in use from 2017 through 2020, based on producer-reported annual magnet set sales⁹⁴ collected by the Directorate for Compliance through mid-2012 and assumptions of annual sales of all subject magnet products through 2020 (including an assumption of 500,000 units per year for 2018-2020), an assumed expected product life of 1.5, 2, and 3 years (line b), and the application of the CPSC's Product Population Model, a computer algorithm that projects the number of products in use given estimates of annual product sales and product failure rates. The Commission requests information on annual sales and expected product life of subject magnet products.

Figure 7 shows changes in the estimated number of subject magnet products in use, from 2009 through 2020.

⁹⁴ Although this information is for magnet sets, and not all subject magnet products, staff primarily had information about magnet sets, and magnet sets likely make up a large portion of subject magnet products.

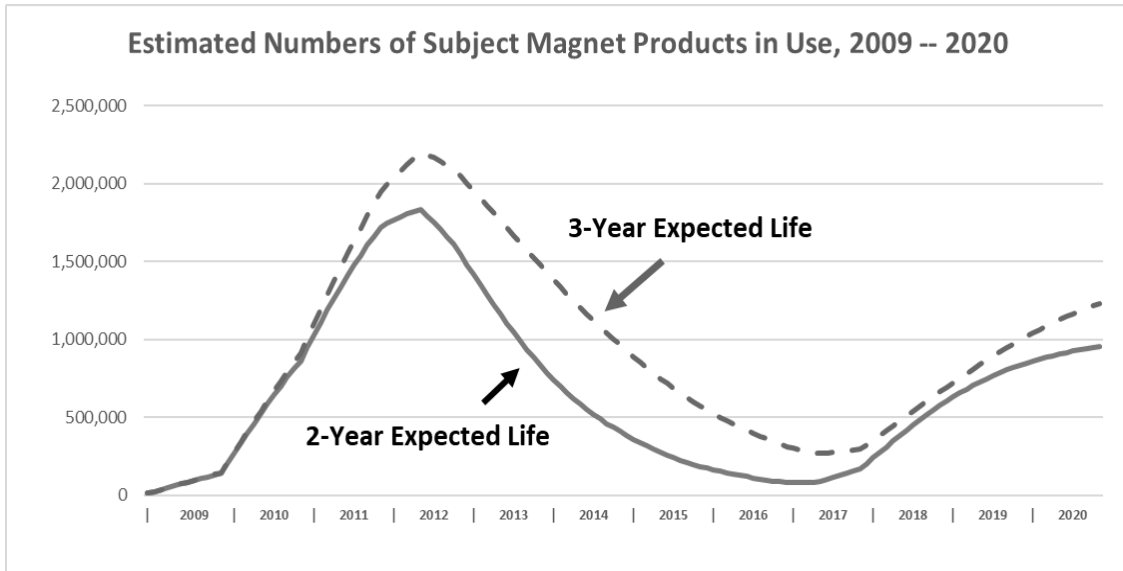

Figure 7: Estimated Numbers of Subject Magnet Products in Use, 2009-2020.

In Table 19, the annual estimated societal costs per subject magnet product in use (line d) are presented as the quotient of the annual societal costs (line a), per product in use, and the estimated average number of products in use (line c). Based on these estimates, and an assumed average product life ranging from 1.5 to 3 years, the present value of societal costs, per subject magnet product, ranges from about \$160 to about \$190 using a 3 percent discount rate (line e), or from about \$154 to \$178 using a 7 percent discount rate (line f).

The first order estimate of benefits would be equal to the present value of societal costs, presented in lines (e) and (f) and would range from about \$154 (with a 1.5-year product life and a 7 percent discount rate) to \$190 (with a 3-year product life and a 3 percent discount rate) per subject magnet product. The aggregate benefits would range from \$80 million to \$95 million using the 500,000 units assumption from Table 19 and 3 percent discount rate.⁹⁵ If the proposed rule allows some products to remain on the market that present the magnet ingestion hazard, the

⁹⁵ Aggregate benefits are the product of the per-unit benefit (\$160 and \$190 for a 1.5-year and 3-year useful life discounted at 3 percent), and 500,000 estimated annual units.

benefits of the rule would be reduced by some unknown amount and would be measured as the net reduction in injuries and the concomitant reduction in societal costs that would result.

4. Costs Associated with the Proposed Rule

This section discusses the costs associated with the proposed rule, which include costs to consumers and to manufacturers/importers of subject magnet products. Both consumers and producers benefit from the production and sale of consumer products. The consuming public obtains the use value or utility associated with the consumption of products; producers obtain income and profits from the production and sale of products. Consequently, the costs of requiring that subject magnet products comply with the proposed rule would consist of: (1) the lost use value experienced by consumers who would no longer be able to purchase magnets that do not meet the standard (lost consumer surplus); and (2) the lost income and profits to firms that could not produce and sell non-complying products (lost producer surplus).

Both consumer and producer surplus depend on product sales, among other things. However, CPSC does not know the unit sales of subject magnet products. Therefore, this analysis considers possible costs associated with several estimates of sales, ranging from about 250,000 to 1 million subject magnet products per year. For purposes of discussion, the analysis below assumes annual sales of 500,000 per year.

a. Costs to Consumers

The primary cost associated with the proposed rule is lost utility to consumers. Subject magnet products may be used for a variety of purposes, including amusement and jewelry. Previous comments CPSC has received regarding magnet sets, which likely comprise the majority of subject magnet products on the market, indicate that consumers use them as a manipulative or construction item for entertainment, such as puzzle working, sculpture building,

mental stimulation, or stress relief. CPSC is also aware of claims that the magnets can have beneficial therapeutic value for children with attention-deficit/hyperactivity disorder. Incident data also suggests that magnet sets are used as jewelry. The individual magnets in subject magnet products might also have additional uses, apart from those for which they are intended (*e.g.*, using magnets from a magnet set on a refrigerator). However, there would presumably be little lost utility for these unintended product uses since products intended for those purposes (*e.g.*, refrigerator magnets) would be unaffected by the proposed rule. If products that comply with the proposed rule do not serve the identical utility (*e.g.*, consumers prefer smaller, stronger magnets), this represents lost utility to consumers. CPSC notes that the proposed rule applies to amusement and jewelry products and, therefore, would not affect products intended for research, education, industrial, or commercial uses, if they do not otherwise meet the definition of subject magnet products.

CPSC cannot estimate the use value that consumers receive from subject magnet products, so the following discussion instead describes use value conceptually. In general, use value includes the amount of: (1) consumer expenditures for the product, plus (2) consumer surplus. Assuming annual sales of about 500,000 subject magnet products annually, and assuming an average retail price of about \$20 (based on price data for magnet sets), consumer expenditures would amount to about \$10 million annually. These expenditures represent the minimum value that consumers would expect to get from these products. It is represented by the area of the rectangle OBDE in the standard supply and demand graph in Figure 8, where B equals \$20, and E equals 500,000 units.

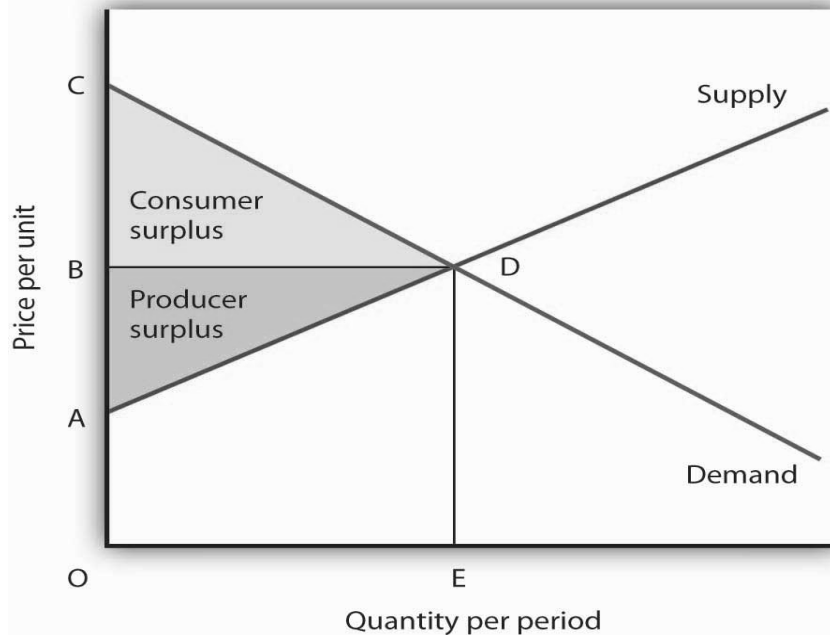

Figure 8: Supply and demand graph illustrating the concepts of consumer and producer surplus.

In Figure 8, consumer surplus is given by the area of the triangle BCD under the graph's demand function, and represents the difference between the market-clearing price and the maximum amount consumers would have been willing to pay for the product. This consumer surplus will vary for individual consumers, but it represents a benefit to consumers over and above what they paid.⁹⁶ For example, tickets to a concert might sell for \$100 each, but some consumers who buy them for \$100 would have been willing to pay \$150 per ticket. Those consumers paid \$100 and received benefits that they value at \$150, thereby receiving a consumer surplus of \$50.⁹⁷

⁹⁶ The concept of consumer surplus is discussed in the Office of Management and Budget's Circular A-4, *Regulatory Analysis*, available through 68 Fed. Reg. 58366 (Oct. 9, 2003), and has been applied in a number of CPSC staff analyses.

⁹⁷ If the above graph represents the market for tickets, the demand curve describes the quantity of tickets demanded at each price (*i.e.*, the quantity of tickets consumers are willing and able to purchase at each price). In this example, the \$150 that the consumer would have been willing to pay for the ticket is represented on the demand curve at a point to the left of point D. The consumer surplus is given by the relevant point on the demand curve (*i.e.*, where price = \$150), minus the market clearing price of \$100.

In general, the use value of the subject magnet products obtained by consumers is represented by the area of the trapezoid OCDE in Figure 8. However, the prospective loss in use value associated with the proposed rule would amount to, at most, the area of the triangle representing the consumer surplus. This is because consumers would no longer be able to obtain utility from the products that do not comply with the proposed rule, but they would have the \$10 million (represented by the rectangle OBDE) that they would have spent on non-complying subject magnet products in the absence of a rule. The net loss in consumer surplus associated with the proposed rule would be reduced by consumers' ability to purchase replacement products that comply with the proposed rule and provide the same utility, or by their ability to purchase other products that provide use-value.

CPSC does not have information regarding aggregate consumer surplus or, by extension, the amount of utility that would be lost as a result of the proposed rule. However, if, for example, consumers who purchased subject magnet products that do not comply with the proposed rule at an average price of \$20 would have been willing to spend, on average, \$35 to \$45 per product (*i.e.*, an additional \$15 to \$25 per product), the lost utility might amount to about \$7.5 million (*i.e.*, $[\$35-\$20] \times 500,000$ units annually) to \$12.5 million (*i.e.*, $[\$45-\$20] \times 500,000$ units annually) on an annual basis.

However, the loss in consumer surplus described above represents the maximum loss of consumer utility from the proposed rule because consumers are likely to gain some amount of consumer surplus from products that are purchased as an alternative to subject magnet products that would no longer be available because of the rule. If, for example, there were close substitutes (*e.g.*, products that are similarly satisfying and priced) for the subject magnet products that do not meet the standard, the overall loss in consumer surplus (and, hence, the costs of the

proposed rule) likely would be small. Staff is aware of subject magnet products that comply with the proposed rule. For example, there are magnet sets with flux indexes less than $50 \text{ kG}^2 \text{ mm}^2$, magnetic desk sculptures that use a magnetic base and ferromagnetic pieces, sets of large magnetic balls, and a wide variety of fidget toys. Manufacturers of magnetic jewelry with loose or separable magnets have options for complying with the rule, including using magnets that are not hazardous, or close substitutes that are nonmagnetic. If jewelry manufacturers wish to offer separable pieces on necklaces or bracelets, they might offer nonmagnetic pieces that attach to a bracelet or necklace incorporating attached magnets. Additionally, magnetic stud earrings and faux piercing jewelry have clip-on alternatives and pierced jewelry as substitutes. These products and alternatives suggest that compliant products may provide similar utility to non-compliant subject magnet products.

b. Costs to Manufacturers/Importers

The lost benefits to firms that could result from the proposed rule are measured by a loss in producer surplus. Producer surplus is a profit measure that is somewhat analogous to consumer surplus. Whereas consumer surplus is a measure of benefits received by individuals who consume products, net of the cost of purchasing the products, producer surplus is a measure of the benefits accrued to firms that produce and sell products, net of the costs of producing them. Producer surplus is defined as the total revenue (TR) of firms selling subject magnet products, less the total variable costs (TVC) of production. Variable costs are costs that vary with the level of output and usually include expenditures for raw materials, wages, distribution of the product, and similar costs.

In Figure 8, above, total revenue is given by the area OBDE, which is the product of sales and price. The total variable costs of production are given by the area under the supply function,

OADE. Consequently, producer surplus is given by the triangle ABD, which is the area under the market clearing price and above the supply function. Note that this represents the maximum loss to producers; if there were product alternatives that were similar to subject magnet products that suppliers could produce and sell, the lost producer surplus could be less.

Following the example above, if sales of the subject magnet products average about 500,000 units annually, with an average retail price of about \$20 per product, then total industry revenues have averaged about \$10 million annually (*i.e.*, 500,000 units \times \$20 per product). Information provided by magnet set sellers suggests that the average import cost of magnet sets to U.S. importers, a major variable cost, may amount to about \$10 per set, or an average of about \$5 million annually (*i.e.* 500,000 sets \times \$10 import cost per set). Apart from the import costs, the variable costs of production are probably relatively small. Because subject magnet products are often packaged and shipped from China and sometimes sent directly to the importers point of sale, U.S. labor costs may be low; and because subject magnet products are small, storage costs are probably low. If, for example, the variable costs of production account for about half of the difference between total revenues (\$10 million) and import costs (\$5 million), producer surplus would amount to about \$2.5 million (*i.e.*, $(\$10 \text{ million} - \$5 \text{ million}) \div 2$) annually. At most, the lost producer surplus would amount to about \$5 million annually, if there were no variable costs other than the costs of importing the magnets (*i.e.*, total revenue of \$10 million for 500,000 units annually less the import costs of about \$5 million). While this information is specifically related to magnet sets, a similar relationship could apply to other subject magnet products.

Like costs to consumers, lost producer surplus could be offset by products that comply with the proposed rule. That is, although firms could not offer subject magnet products that do

not comply with the proposed rule, they could offer substitutions that serve the same or similar purpose but comply with the proposed rule.

As noted above, CPSC does not know the actual sales levels of non-complying subject magnet products, and does not have information to reliably estimate either consumer surplus or producer surplus. Table 20, below, provides rough estimates of the possible costs of the rule, for various hypothetical sales levels ranging from 250,000 to 1 million products annually. The cost estimates are based on a number of assumptions described above, and are made for illustrative purposes. Nevertheless, because the range of sales is wide, and is likely to include actual sales levels on an annual basis, it is reasonable to assume that the costs of the proposed rule could range from about \$5 to \$8.75 million (if sales amount to about 250,000 products annually), to about \$20 to \$35 million (if sales amount to about 1 million products annually). As noted above, these costs could be partially offset by products that comply with the proposed rule.

Table 20: Possible Costs of the Proposed Rule, for Various Levels of Non-Complying Subject Magnet Product Sales

Magnet Product Sales (annually)	Consumer Surplus (millions \$)	Producer Surplus (millions \$)	Total Costs (millions \$)
250,000	\$3.75 to \$6.25	\$1.25 to \$2.5	\$5 to \$8.75
500,000	\$7.5 to \$12.5	\$2.5 to \$5	\$10 to \$17.5
750,000	\$11.25 to \$18.75	\$3.75 to \$7.5	\$15 to \$26.25
1,000,000	\$15 to \$25	\$5 to \$10	\$20 to \$35

In addition to lost producer surplus, manufacturers/importers of subject magnet products that comply with the proposed rule would likely incur some additional costs associated with certifying that their products comply with the rule. Section **XII. Testing, Certification, and Notice of Requirements**, below, describes the requirements in section 14 of the CPSA regarding certifications. To summarize, consumer products that are subject to a mandatory standard must

be certified as complying with the standard. Certification must be based on a test of each product or a reasonable testing program. For subject magnet products, the costs of this testing may be minimal, especially for manufacturers that currently have product testing done for products subject to the requirements in ASTM F963-17, which is mandated in 16 CFR part 1250.

Importers may rely upon testing completed by other parties, such as their foreign suppliers, if those tests provide sufficient information for the manufacturers or importers to certify that the magnets in their products comply with the proposed rule. For subject magnet products that are children's products, such as children's jewelry, the certification must be based on testing by an accredited third-party conformity assessment body, at somewhat higher costs.

B. Reasons for Not Relying on a Voluntary Standard

When the Commission issues an ANPR, it must invite interested parties to submit existing standards or provide a statement of intention to modify or develop a standard that would address the hazard at issue. 15 U.S.C. 2058(a). When CPSC receives such standards or statements in response to an ANPR, the preliminary regulatory analysis must provide reasons that the proposed rule does not include such standards. *Id.* 2058(c). In the present rulemaking, the Commission did not issue an ANPR. Accordingly, CPSC did not receive submissions of standards or statement of intention to develop standards regarding the magnet ingestion hazard.

Nevertheless, staff evaluated existing standards relevant to magnet ingestions and determined that these standards would not adequately reduce the risk of injury associated with magnet ingestions because they do not cover the products most often involved in incidents or do not include adequate performance requirements to reduce the risk of injury. A detailed discussion of these standards, and why staff considers them inadequate, is in section **V. Relevant Existing Standards**.

C. Alternatives to the Proposed Rule

Finally, a preliminary regulatory analysis must describe alternatives to the proposed rule that CPSC considered, their potential costs and benefits, and a brief explanation of the reasons the alternatives were not chosen. CPSC considered several alternatives to the proposed rule. These alternatives, their potential costs and benefits, and the reasons the Commission did not select them, are described in detail in section **VIII. Alternatives to the Proposed Rule**, below, and Tab F of the NPR briefing package.

VIII. Alternatives to the Proposed Rule

CPSC considered several alternatives to reduce the risk of injuries and death associated with ingestion of subject magnet products. However, as discussed below, CPSC does not consider any of these alternatives capable of adequately reducing the risk of injury and death.

A. No Mandatory Standard

One alternative to the proposed rule is to take no regulatory action and, instead, rely on the ASTM standards to address the magnet ingestion hazard. As discussed above, there are four ASTM standards that address the magnet ingestion hazard, covering children's toys, jewelry, and magnet sets. Relying on these standards would eliminate the costs associated with the proposed rule because it would not mandate compliance. ASTM F3458, in particular, has the potential to address the magnet ingestion hazard because it applies to magnet sets, which are involved in a large portion of magnet ingestion incidents where the product type could be identified.

However, there are considerable limitations and unknowns associated with this alternative. The shortcomings of the ASTM standards are discussed in detail in section **V. Relevant Existing Standards**. For one, CPSC does not consider ASTM F3458 capable of adequately reducing the magnet ingestion hazard because of its limited scope and lack of size

and strength requirements for magnets. Although Subcommittee F15.77 on Magnets formed a task group to consider revising ASTM F3458-21 to include performance requirements for magnet sets intended for users 14 years and older, CPSC does not know whether the standard will be revised or what requirements may be added to it.

Moreover, ASTM F3458 applies only to magnets sets, which are not the only products implicated in magnet ingestion incidents. Additional magnet toys intended for users 14 years and older, as well as jewelry are also implicated. Although ASTM has standards regarding the magnet ingestion hazard in jewelry, CPSC considers those standards inadequate because they do not impose size and strength limits on all jewelry with loose or separable magnets. In addition, CPSC does not know the level of compliance with ASTM F3458, ASTM F2999, or ASTM F2923; if the rate of compliance is low, these would not be an effective way to address the hazard, even if the requirements in these standards were adequate. Finally, waiting for ASTM to revise its standards to adequately address the hazard would delay the safety benefits of the proposed rule. For these reasons, the Commission did not select this alternative.

B. Alternative Performance Requirements

Another alternative to the proposed rule is to adopt a mandatory standard with less stringent requirements than the proposed rule, such as a higher flux index limit, or different requirements for certain shapes and sizes of magnets. This may reduce the costs associated with the rule by allowing firms to market and consumers to use a wider variety of products than under the proposed rule. The reduction in costs would depend on the specific requirements adopted.

However, this option would likely reduce the safety benefits of the rule. If the alternative performance requirements reduced costs by allowing more products to remain on the market, it likely would also leave more hazardous products on the market, thereby decreasing the safety

benefits. Therefore, the Commission did not select this alternative. The Commission seeks comments on what potential alternative performance requirements may adequately reduce the risk of injury associated with magnet ingestions, while reducing costs to firms and impacts on consumer utility.

C. Safety Messaging

Instead of performance requirements, the Commission could require safety messaging on products to address the magnet ingestion hazard, such as through requirements for labeling and instructional literature. This alternative would reduce the costs associated with the proposed rule because it would allow firms to continue to sell subject magnet products with loose or separable hazardous magnets and the costs of warnings and instructional information likely would be small.

However, CPSC does not consider this alternative effective for adequately reducing the risk of injury and death associated with magnet ingestions. For a detailed discussion of why labeling and instructional literature requirements are insufficient to adequately address the magnet ingestion hazard, see section *V.D. ASTM F3458-21*. To summarize, warnings are the least effective strategy for addressing a hazard, relative to designing out the hazard or designing guards against the hazard. The effectiveness of warnings depends on convincing consumers to avoid the hazard, and there are numerous reasons consumers may disregard warnings for these products. Caregivers do not expect older children and teens to ingest inedible objects; the magnet ingestion hazard is not readily apparent; caregivers and children underappreciate the likelihood and severity of the hazard; magnets are often ingested accidentally; and children and teens commonly access magnets without their packaging, such as from friends or at school.

Warning information on labels and instructional literature, as well as public outreach efforts to inform consumers of the hazard, have been used to try to address the magnet ingestion hazard for many years. However, these efforts have been unsuccessful at reducing the magnet ingestion hazard, as evidenced by the increase in magnet ingestion incidents in recent years, and magnet ingestion incidents involving products with clear warnings.

For these reasons, the Commission did not select this alternative.

D. Packaging Requirements

Another alternative is for the Commission to require special packaging for subject magnet products that contain hazardous magnets to limit children's access to the products. Such packaging could, for example, help consumers determine if all magnets have been returned to the packaging and include child-resistant features. Although this alternative would create some costs associated with packaging, those costs likely would be lower than the proposed rule because they would allow subject magnet products to remain unchanged. Staff estimates that the cost of safety packaging may amount to about \$1 per magnet product, depending on the requirements and features of the packaging.

However, CPSC does not consider this alternative effective for adequately reducing the risk of injury and death associated with magnet ingestions. For a detailed discussion of why packaging requirements are insufficient to adequately address the magnet ingestion hazard, see section *V.D. ASTM F3458-21*. To summarize, for packaging requirements to be effective at preventing the magnet ingestion hazard, users would have to repackage all magnets after each use, and the packaging would have to prevent children and teens from accessing the magnets. Neither of these are likely to occur to a sufficient extent to address the hazard.

For one, consumers are unlikely to repackaging all magnets after each use. After assembling structures or jewelry, or using the magnets for other purposes, consumers would be unlikely to disassemble their creations to return them to the package. In addition, products often contain hundreds or thousands of magnets, making it time consuming and difficult to ensure all of the magnets are returned to the package. Moreover, small magnets become loose in the environment and are hard to locate to return to the package. In addition, consumers often do not perceive subject magnet products as hazardous, making it less likely that they would repackaging all of the magnets. Even for products that are obviously hazardous and commonly use CR packaging, such as chemicals and pharmaceuticals, consumers use the packaging inconsistently. Consumers may also consider CR packaging a nuisance, making them unlikely to store magnets in the packaging after every use.

Even if consumers return all magnets to a package after each use, safety features to prevent easy access to the contents of the package would only address a minority of the vulnerable population. Safety packaging is generally intended to restrict children under 5 years old from accessing package contents. Older children and teens are likely to have the cognitive and motor skills necessary to access products in special packaging. This is problematic because incident data show that older children and teens make up the majority of magnet ingestion victims. In addition, many incidents involve children and teens acquiring magnets without the product packaging, such as from friends, at school, or loose in the environment. For these reasons, the Commission did not select this alternative.

E. Aversive Agents

Instead of the size and strength requirements in the proposed rule, the Commission could require manufacturers to coat loose or separable hazardous magnets in subject magnet products

with aversive agents, such as foul odors or bitterants. Aversive agents may dissuade some children and teens from placing hazardous magnets in their mouths. This alternative would reduce the costs associated with the proposed rule because it would allow firms to continue to sell subject magnet products with loose or separable hazardous magnets, would allow consumers to continue to use them, and the costs of such coatings likely would be small.

However, real-world investigations have not demonstrated that bitterants are effective at preventing ingestions.⁹⁸ Bitterants do not deter initial ingestion because the user has not yet tasted the bitterant; this makes them ineffective at protecting users from harms that can result from a single ingestion. Incident reports indicate that ingesting a single magnet (and ferromagnetic object), or multiple magnets at once or in quick succession, can result in serious injuries. Thus, the ineffectiveness of bitterants to prevent an initial ingestion makes them ineffective for addressing the magnet ingestion hazard.

Similarly, once a magnet is in a person's mouth, they may not be able to prevent ingestion even if deterred by a bitterant. The power of the magnetic forces can cause magnets to move erratically as pieces repel or attract, and movement of magnets toward the back of the throat can trigger the reflex to swallow the magnets before the person can remove them. Bitterants would be particularly ineffective for accidental ingestions, where victims did not intentionally place magnets in their mouths; incident data indicate that some magnet ingestions involve unintentional ingestions, particularly for older victims. Moreover, incidents involving ingestion of other hazardous substances demonstrates the ineffectiveness of aversive agents to prevent ingestions. Children frequently ingest unpalatable substances, such as gasoline, cleaners, and ammonia, indicating that unpleasant taste or odor, alone, is not sufficient to deter children

⁹⁸ This alternative is discussed in detail in the Final Rule briefing package for the 2014 rule on magnet sets, available at: https://www.epsc.gov/s3fs-public/pdfs/foia_SafetyStandardforMagnetSets-FinalRule.pdf.

from ingesting items or substances. In addition, some portion of the population, possibly as high as 30 percent, may be insensitive to certain bitterants.

For these reasons, the Commission did not select this alternative.

F. Longer Effective Date

Another alternative is to provide a longer effective date for a final rule. In this proposed rule, the Commission proposes to make a final rule effective 180 days after the final rule is published. A longer effective date would reduce the impact of the rule on manufacturers and importers by extending the time firms have to develop products that comply with the rule or modify products to comply with the rule. However, delaying the effective date would delay the safety benefits of the rule as well. As such, the Commission did not select this alternative. However, the Commission requests comments about the proposed effective date.

IX. Paperwork Reduction Act

This proposed rule does not contain a collection of information that is subject to public comment and review by the Office of Management and Budget under the Paperwork Reduction Act of 1995 (44 U.S.C. 3501-3521).⁹⁹

X. Initial Regulatory Flexibility Analysis¹⁰⁰

When an agency is required to publish a proposed rule, section 603 of the Regulatory Flexibility Act (5 U.S.C. 601-612) requires that the agency prepare an initial regulatory flexibility analysis (IRFA) that describes the impact that the rule would have on small businesses and other entities. An IRFA is not required if the head of an agency certifies that the proposed

⁹⁹ There is an Office of Management and Budget control number, under the Paperwork Reduction Act, for collection of information regarding third-party testing for children's products, addressed in 16 CFR part 1107.

¹⁰⁰ Further details about the initial regulatory flexibility analysis are available in Tab F of the NPR briefing package. Additional information about costs associated with the rule are available in Tab E of the NPR briefing package.

rule will not have a significant economic impact on a substantial number of small entities. 5

U.S.C. 605. The IRFA must contain:

- (1) a description of why action by the agency is being considered;
- (2) a succinct statement of the objectives of, and legal basis for, the proposed rule;
- (3) a description of and, where feasible, an estimate of the number of small entities to which the proposed rule will apply;
- (4) a description of the projected reporting, recordkeeping and other compliance requirements of the proposed rule, including an estimate of the classes of small entities that will be subject to the requirement and the type of professional skills necessary for preparation of the report or record; and
- (5) identification, to the extent practicable, of relevant Federal rules that may duplicate, overlap, or conflict with the proposed rule.

An IRFA must also describe any significant alternatives that would accomplish the objectives of the applicable statutes and minimize any significant economic impact on small entities.

Alternatives could include: (1) establishing different compliance or reporting requirements that consider the resources available to small businesses; (2) clarification, consolidation, or simplification of compliance and reporting requirements for small entities; (3) use of performance rather than design standards; and (4) an exemption from coverage of the rule, or any part of the rule thereof, for small entities.

The IRFA for this proposed rule is available in Tab F of the NPR briefing package; this section provides an overview of the impact of the proposed rule on small businesses.

A. Reason for Agency Action

The intent of this rulemaking is to reduce deaths and injuries resulting from magnet ingestions. As incident data show, magnet ingestion incidents have increased in recent years, and commonly involve products categorized as amusement or jewelry products. Most incidents involve children and teens, particularly under 14 years old. If ingested, some magnets are powerful enough to interact internally with one another through body tissue, and resist natural bodily forces to separate the magnets. This interaction has led to serious injuries and several deaths in the United States. The internal interaction hazard is a hidden hazard, which children and caregivers are unlikely to anticipate, appreciate, and avoid, as demonstrated by incident data. Incident data and the health outcomes of magnet ingestions demonstrate the need for agency action.

B. Objectives of and Legal Basis for the Rule

The objective of the proposed rule is to reduce the risk of injury and death associated with ingestion of hazardous magnets, as discussed above. The proposed rule would be issued under the authority of sections 7 and 9 of the CPSA.

C. Small Entities to Which the Rule Will Apply

The proposed rule would apply to small entities that manufacture, import, or sell subject magnet products, which are products with one or more magnets, which are loose or separable, and designed, marketed, or intended to be used by consumers for entertainment, jewelry (including children's jewelry), mental stimulation, stress relief, or a combination of these purposes. Examples of subject magnet products include magnet sets, other types of magnet toys intended for users 14 years and older, and jewelry with separable magnets that can be arranged by the consumer.

Because CPSC's previous rulemaking work regarding magnet ingestions has focused on magnet sets, CPSC staff has more detailed information about magnet sets than other subject magnet products. For this reason, this analysis provides detailed information about magnet sets; however, staff also provides information about additional subject magnet products, to the extent information about these products is available.

All of the importers of magnet sets are small businesses under U.S. Small Business Administration (SBA) size standards, and CPSC expects that this is also true for manufacturers and importers of other subject magnet products. Currently, nearly all marketers (firms or individuals) of magnet sets sell through internet sites, rather than through physical retail stores such as bookstores, gift shops and other outlets (which commonly sold magnet sets from 2009 through mid-2012). Some of these internet sites are operated by the importers, but the majority of sellers (in terms of distinct firms or individuals, if not unit sales) appear to sell through their stores, operated on the sites of other internet platforms. These online retail outlets may also be used commonly by manufacturers and sellers of other subject magnet products.

As discussed above, in late 2018, IEc examined the market for magnet sets. In its review of internet platforms, IEc found a total of 69 sellers. IEc also identified 10 manufacturers and 2 retailers, which also are small businesses.¹⁰¹ CPSC staff provided IEc with staff's prior research, which identified at least 121 sellers of magnet sets on two major internet retail platforms. IEc reviewed these sellers with the intention of merging CPSC's research with newer information but

¹⁰¹ IEc classified manufacturers as firms producing and selling their own magnet set products, and retailers as firms that typically sell magnets from multiple manufacturers.

found that the vast majority of sellers CPSC identified no longer sold magnet sets, indicating high turnover rates.

In 2020, CPSC staff reviewed the status of previously identified sellers of magnet sets on two major internet platforms and found further evidence of high turnover rates: most of the sellers identified in late 2018 no longer sold magnet sets or had abandoned their stores. Only 9 of 69 sellers were still selling magnet sets. The remaining sellers no longer offered magnet sets or no longer operated on the platforms. In addition, staff identified 29 sellers that IEC had not identified as active in the market in late 2018.

Based on this information, CPSC staff expects the dominant business model for importers of magnet sets will be direct sales to consumers using their own internet websites or other internet shopping sites. However, the proposed rule could also affect some third-party retailers of the products, whether selling them online or in physical stores. Such retailers sell a wide variety of consumer products; retailers classified as small businesses that sell the products would not be likely to derive significant proportions of total revenues from sales of affected magnet sets, and the impacts on individual firms should be minimal.

D. Compliance, Reporting, and Recordkeeping Requirements in the Proposed Rule

The proposed rule would establish a mandatory standard that all subject magnet products would have to meet to be sold in the United States. As stated above, the proposed rule would require consumer products that are designed, marketed, or intended to be used for entertainment, jewelry, mental stimulation, stress relief, or a combination of these purposes, and that contain one or more loose or separable magnets to meet performance requirements. The proposed performance requirements specify that each loose or separable magnet in a subject magnet product that is small enough to fit entirely in the small parts cylinder must have a flux index less

than 50 kG² mm². The requirements of the proposed standard are described, in detail, in this preamble, and the proposed regulatory text is at the end of this notice.

In addition, certification requirements, which are discussed in section **XII. Testing, Certification, and Notification of Requirements**, below, would apply to subject magnet products. To summarize, section 14 of the CPSA requires manufacturers, importers, or private labelers of a consumer product that is subject to a consumer product safety rule to certify, based on a test of each product or a reasonable testing program, that the product complies with all rules, bans or standards applicable to the product. The proposed rule specifies the test procedure to use to determine whether a subject magnet product complies with the requirements. For products that manufacturers certify, manufacturers would issue a general certificate of conformity (GCC). In the case of subject magnet products that could be considered children's products, the certification must be based on testing by an accredited third-party conformity assessment body.

The requirements for the GCC are stated in section 14 of the CPSA. Among other requirements, each certificate must identify the manufacturer or private labeler issuing the certificate and any third-party conformity assessment body on whose testing the certificate relies; the date and place of manufacture; the date and place where the product was tested; each party's name, full mailing address, telephone number; and contact information for the individual responsible for maintaining records of test results. The certificates must be furnished to each distributor or retailer of the product and to CPSC, if requested.

1. Costs of the Proposed Rule That Would be Incurred by Small Manufacturers

Small manufacturers and importers of subject magnet products would likely incur some costs to certify that their products meet the requirements of the proposed rule, as required by

section 14 of the CPSA. The certification must be based on a test of each product or a reasonable testing program. The costs of the testing might be minimal, especially for small manufacturers that currently have product testing done for products subject to the requirements in ASTM F963-17, which is mandated by 16 CFR part 1250. Importers may also rely on testing completed by other parties, such as their foreign suppliers, if those tests provide sufficient information for the manufacturers or importers to certify that the magnets in their products comply with the proposed rule. As noted above, for subject magnet products that could be considered children's products, such as children's jewelry, the certification must be based on testing by an accredited third-party conformity assessment body, at somewhat higher costs. The Commission requests comments regarding the costs or other impacts of the certification requirements under section 14 of the CPSA.

2. Impact on Small Businesses

As discussed in the preliminary regulatory analysis, the primary impact of the proposed rule on small businesses would be the lost income and profits to firms that could not produce, import, and sell non-complying products in the future. The lost benefits to firms resulting from a proposed rule are measured by a loss in producer surplus, which is a measure of the total revenue of firms selling the magnets, less the total variable costs of production. As predominantly imported products, the variable costs for small businesses handling subject magnet products are mainly the import costs. The producer surplus for magnet sets could average about \$5 to \$10 per unit, based on an average price of \$20. A similar relationship could apply to other subject magnet products affected by the proposed rule.

A few small firms whose businesses focus on sales of subject magnet products that would not comply with the proposed rule, including some of the firms selling products on their own

websites, would face relatively greater losses in producer surplus. These and other small businesses could respond to the rule by marketing magnets that comply with or are not subject to the proposed rule. Such measures could offset losses in producer surplus.

E. Federal Rules That May Duplicate, Overlap, or Conflict with the Proposed Rule

CPSC did not identify any federal rules that duplicate, overlap, or conflict with the proposed rule.

F. Alternatives Considered to Reduce the Burden on Small Entities

As discussed in section **VIII. Alternatives to the Proposed Rule**, above, CPSC examined several alternatives to the proposed rule, which could reduce the burden on firms, including small entities. For the reasons described in that section, the Commission concluded that those alternatives would not adequately reduce the risk of injury and death associated with magnet ingestions, and is not proposing those alternatives. See Tab F of the NPR briefing package for further discussion of alternatives to the proposed rule. The Commission seeks comments on any alternatives that would reduce the impact on small entities, while adequately reducing the risk of injury and death associated magnet ingestions.

XI. Incorporation by Reference

The proposed rule incorporates by reference ASTM F963-17. The Office of the Federal Register (OFR) has regulations regarding incorporation by reference. 1 CFR part 51. Under these regulations, in the preamble of an NPR, an agency must summarize the incorporated material, and discuss the ways in which the material is reasonably available to interested parties or how the agency worked to make the materials reasonably available. 1 CFR 51.5(a). In accordance

with the OFR requirements, this preamble summarizes the provisions of ASTM F963-17 that the Commission proposes to incorporate by reference.

The standard is reasonably available to interested parties and interested parties can purchase a copy of ASTM F963-17 from ASTM International, 100 Barr Harbor Drive, P.O. Box C700, West Conshohocken, PA 19428-2959 USA; telephone: (610) 832-9585; www.astm.org. Additionally, during the NPR comment period, a read-only copy of ASTM F963-17 is available for viewing on ASTM's website at: <https://www.astm.org/CPSC.htm>. Once a final rule takes effect, a read-only copy of the standard will be available for viewing on the ASTM website at: <https://www.astm.org/READINGLIBRARY/>. Interested parties can also schedule an appointment to inspect a copy of the standard at CPSC's Division of the Secretariat, U.S. Consumer Product Safety Commission, 4330 East West Highway, Bethesda, MD 20814, telephone: (301) 504-7479; e-mail: cpsc-os@cpsc.gov.

XII. Testing, Certification, and Notice of Requirements

Section 14(a) of the CPSA includes requirements for certifying that children's products and non-children's products comply with applicable mandatory standards. 15 U.S.C. 2063(a). Section 14(a)(1) addresses required certifications for non-children's products, and sections 14(a)(2) and (a)(3) address certification requirements specific to children's products.

A "children's product" is a consumer product that is "designed or intended primarily for children 12 years of age or younger." *Id.* 2052(a)(2). The following factors are relevant when determining whether a product is a children's product:

- manufacturer statements about the intended use of the product, including a label on the product if such statement is reasonable;

- whether the product is represented in its packaging, display, promotion, or advertising as appropriate for use by children 12 years of age or younger;
- whether the product is commonly recognized by consumers as being intended for use by a child 12 years of age or younger; and
- the Age Determination Guidelines issued by CPSC staff in September 2002, and any successor to such guidelines.

Id. “For use” by children 12 years and younger generally means that children will interact physically with the product based on reasonably foreseeable use. 16 CFR 1200.2(a)(2). Children’s products may be decorated or embellished with a childish theme, be sized for children, or be marketed to appeal primarily to children. *Id.* 1200.2(d)(1).

As discussed above, some subject magnet products (*e.g.*, children’s jewelry) are children’s products and some are not. Therefore, a final rule would require subject magnet products that are not children’s products to meet the certification requirements under section 14(a)(1) of the CPSA and would require subject magnet products that are children’s products to meet the certification requirements under sections 14(a)(2) and (a)(3) of the CPSA. The Commission’s requirements for certificates of compliance are codified in 16 CFR part 1110.

Non-Children’s Products. Section 14(a)(1) of the CPSA requires every manufacturer (which includes importers¹⁰²) of a non-children’s product that is subject to a consumer product safety rule under the CPSA or a similar rule, ban, standard, or regulation under any other law enforced by the Commission to certify that the product complies with all applicable CPSC requirements. 15 U.S.C. 2063(a)(1).

¹⁰² The CPSA defines a “manufacturer” as “any person who manufactures or imports a consumer product.” 15 U.S.C. 2052(a)(11).

Children's Products. Section 14(a)(2) of the CPSA requires the manufacturer or private labeler of a children's product that is subject to a children's product safety rule to certify that, based on testing by a third-party conformity assessment body (*i.e.*, testing laboratory), the product complies with the applicable children's product safety rule. *Id.* 2063(a)(2). Section 14(a) also requires the Commission to publish a notice of requirements (NOR) for a testing laboratory to obtain accreditation to assess conformity with a children's product safety rule. *Id.* 2063(a)(3)(A). Because some subject magnet products are children's products, the proposed rule is a children's product safety rule, as applied to those products. Accordingly, if the Commission issues a final rule, it must also issue an NOR.

The Commission published a final rule, codified at 16 CFR part 1112, entitled *Requirements Pertaining to Third Party Conformity Assessment Bodies*, which established requirements and criteria concerning testing laboratories. 78 Fed. Reg. 15836 (Mar. 12, 2013). Part 1112 includes procedures for CPSC to accept a testing laboratory's accreditation and lists the children's product safety rules for which CPSC has published NORs. When CPSC issues a new NOR, it must amend part 1112 to include that NOR. Accordingly, as part of this NPR, the Commission proposes to amend part 1112 to add this proposed standard for magnets to the list of children's product safety rules for which CPSC has issued an NOR.

Testing laboratories that apply for CPSC acceptance to test subject magnet products that are children's products for compliance with the new rule would have to meet the requirements in part 1112. When a laboratory meets the requirements of a CPSC-accepted third party conformity assessment body, the laboratory can apply to CPSC to include 16 CFR part 1262, *Safety Standard for Magnets*, in the laboratory's scope of accreditation of CPSC safety rules listed on the CPSC website at: www.cpsc.gov/labsearch.

XIII. Environmental Considerations

The Commission's regulations address whether CPSC is required to prepare an environmental assessment (EA) or an environmental impact statement (EIS). 16 CFR 1021.5. Those regulations list CPSC actions that "normally have little or no potential for affecting the human environment," and, therefore, fall within a "categorical exclusion" under the National Environmental Policy Act (42 U.S.C. 4231-4370h) and the regulations implementing it (40 CFR parts 1500-1508) and do not require an EA or EIS. 16 CFR 1021.5(c). Among those actions are rules that provide performance standards for products. *Id.* 1021.5(c)(1). Because this proposed rule would create performance requirements for subject magnet products, the proposed rule falls within the categorical exclusion, and thus, no EA or EIS is required.

XIV. Preemption

Executive Order (EO) 12988, *Civil Justice Reform* (Feb. 5, 1996), directs agencies to specify the preemptive effect of a rule in the regulation. 61 Fed. Reg. 4729 (Feb. 7, 1996), section 3(b)(2)(A). In accordance with EO 12988, CPSC states the preemptive effect of the proposed rule, as follows:

The regulation for subject magnet products is proposed under authority of the CPSA. 15 U.S.C. 2051-2089. Section 26 of the CPSA provides that "whenever a consumer product safety standard under this Act is in effect and applies to a risk of injury associated with a consumer product, no State or political subdivision of a State shall have any authority either to establish or to continue in effect any provision of a safety standard or regulation which prescribes any requirements as to the performance, composition, contents, design, finish, construction, packaging or labeling of such product which are designed to deal with the same risk of injury associated with such consumer product, unless such requirements are identical to the

requirements of the Federal Standard.” 15 U.S.C. 2075(a). The federal government, or a state or local government, may establish or continue in effect a non-identical requirement for its own use that is designed to protect against the same risk of injury as the CPSC standard if the federal, state, or local requirement provides a higher degree of protection than the CPSA requirement. *Id.* 2075(b). In addition, states or political subdivisions of a state may apply for an exemption from preemption regarding a consumer product safety standard, and the Commission may issue a rule granting the exemption if it finds that the state or local standard: (1) provides a significantly higher degree of protection from the risk of injury or illness than the CPSA standard, and (2) does not unduly burden interstate commerce. *Id.* 2075(c).

Thus, the requirements proposed in today’s **Federal Register** would, if finalized, preempt non-identical state or local requirements for subject magnet products designed to protect against the same risk of injury and prescribing requirements regarding the performance, composition, contents, design, finish, construction, packaging or labeling of subject magnet products.

XV. Effective Date

The CPSA requires that consumer product safety rules take effect not later than 180 days after the date the rule is promulgated unless the Commission finds, for good cause shown, that a later effective date is in the public interest and publishes the reasons for that finding. 15 U.S.C. 2058(g)(1). To allow time for subject magnet products to come into compliance with the standard, the Commission proposes that this rule, and the amendment to part 1112, become effective 180 days after publication of the final rule in the **Federal Register**. The rule would

apply to all subject magnet products manufactured or imported on or after the effective date. The Commission requests comments on the proposed effective date.

XVI. Proposed Findings

As discussed in section **II. Statutory Authority**, above, the CPSA requires the Commission to make certain findings when issuing a consumer product safety standard. 15 U.S.C. 2058(f)(1), (f)(3). This section discusses preliminary support for those findings.

A. Degree and Nature of the Risk of Injury

To issue a final rule, the CPSA requires the Commission to make findings regarding the degree and nature of the risk of injury the rule is designed to eliminate or reduce. NEISS incident data indicate that there were an estimated 4,400 magnet ingestions treated in U.S. hospital EDs between January 1, 2010 and December 31, 2020 that involved products categorized as being for amusement or jewelry, which are the products subject to this rule. An additional estimated 18,100 ED-treated magnet ingestions during this period involved unidentified magnet products. CPSC concludes that a large portion of these unidentified magnet product incidents likely involved subject magnet products, for the reasons stated below.

In addition to magnet ingestion injuries treated in U.S. hospital EDs, the ICM projects that there were an estimated 3,255 magnet ingestion injuries per year treated in medical settings other than EDs from 2017 through 2020. Incident reports available through CPSRMS indicate that there were at least 284 magnet ingestions between January 1, 2010 and December 31, 2020, 75 percent of which involved products categorized as being for amusement or jewelry, which are the products subject to this rule, and an additional 15 percent involved unidentified magnet

products, which CPSC concludes are likely to have involved subject magnet products for the reasons stated below.

The potential injuries when a person ingests one or more magnets are serious. Health threats posed by magnet ingestion include pressure necrosis, volvulus, bowel obstruction, bleeding, fistulae, ischemia, inflammation, perforation, peritonitis, sepsis, ileus, ulceration, aspiration, and death, among others. These conditions can result from magnets attracting to each other through internal body tissue, or a single magnet attracting to a ferromagnetic object. CPSC is aware of several fatal magnet ingestion incidents resulting from internal interaction of the magnets.

As indicated above, CPSC concludes that many of the magnet ingestion incidents for which information was insufficient to identify the specific product type involved subject magnet products. This conclusion is supported by incident data, trends in magnet ingestion rates and recalls surrounding mandatory standards, and behavioral and developmental considerations. Incident data indicate that, of the magnet ingestion incidents for which CPSC could identify a product type, the primary products involved were magnet sets, magnet toys, and jewelry; this is likely to apply to incidents that lacked product identification information as well.

Trends in magnet ingestion rates surrounding a previous Commission rule on magnet sets indicate that magnet ingestions significantly declined during the time the rule was in effect, and significantly increased after the rule was vacated. This indicates that a large portion of magnet ingestions involved magnet sets, which are subject magnet products. Similarly, incident data and recalls surrounding the Commission's mandatory standard for magnets in children's toys, in 16 CFR part 1250, indicate that, while amusement products are involved in most magnet ingestion incidents with identifiable product types, those amusement products are not children's toys.

Relatively few magnet ingestion incidents identify children's toys as the product involved, suggesting that these make up few of the unidentified product type incidents as well. And the number of recalls of children's products for magnet-related hazards has appreciably declined since 16 CFR part 1250 took effect, suggesting that these products do not make up a large portion of magnet ingestion incidents.

Finally, behavioral and developmental factors support the conclusion that many magnet ingestions with unidentified product types involve subject magnet products. These include the attractiveness of magnetic products and their features to children and teens, consumers' perception that amusement and jewelry products are appropriate and safe for children, and consumers' underappreciation of the magnet ingestion hazard.

B. Number of Consumer Products Subject to the Proposed Rule

To issue a final rule, the CPSA requires the Commission to make findings regarding the approximate number of consumer products subject to the rule. Staff estimates that there are approximately 500,000 subject magnet products sold annually in the United States. However, to account for a range of sales estimates, staff also provided information for sales ranging from 250,000 to 1 million units annually.

C. The Public Need for Subject Magnet Products and the Effects of the Proposed Rule on Their Utility, Cost, and Availability

To issue a final rule, the CPSA requires the Commission to make findings regarding the public's need for the products subject to the rule and the probable effect of the rule on the cost, availability, and utility of such products. Consumers use subject magnet products for entertainment, mental stimulation, stress relief, and jewelry. The proposed rule requires subject magnet products to meet performance requirements regarding size or strength, but does not

restrict the design of products. As such, subject magnet products that meet the standard would continue to serve the purpose of amusement or jewelry for consumers. Magnets that comply with the proposed rule, such as non-separable magnets, larger magnets, weaker magnets, or non-permanent magnets, would likely still be useful for amusement or jewelry. However, it is possible that there may be some negative effect on the utility of subject magnet products if compliant products function differently or do not include certain desired characteristics.

Retail prices of subject magnet products generally average under \$20. CPSC has identified subject magnet products that comply with the proposed rule, indicating that the costs of compliant and non-compliant products are comparable.

If the costs associated with redesigning or modifying subject magnet products to comply with the proposed rule result in manufacturers discontinuing products, there may be some loss in availability to consumers. However, this would be mitigated to the extent that compliant products meet the same consumer needs.

D. Other Means to Achieve the Objective of the Proposed Rule, While Minimizing Adverse Effects on Competition and Manufacturing

To issue a final rule, the CPSA requires the Commission to make findings regarding ways to achieve the objective of the rule while minimizing adverse effects on competition, manufacturing, and commercial practices. CPSC considered several alternatives to achieve the objective of reducing unreasonable risks of injury and death associated with magnet ingestions.

One alternative is to take no regulatory action and instead rely on existing ASTM standards to address the magnet ingestion hazard. This would eliminate costs associated with the rule by avoiding a mandatory standard; however, this alternative is unlikely to adequately reduce the risk of injury and death associated with magnet ingestions. For one, none of the existing

standards address all of the products most commonly identified in magnet ingestion incidents, and several of the standards provide exceptions to performance requirements for certain subject magnet products. In addition, under the existing standards, certain subject magnet products would not be subject to performance requirements regarding size and strength, instead relying on alternative requirements, such as safety messaging, which is unlikely to adequately reduce the magnet ingestion hazard.

Another alternative is a mandatory standard with less stringent requirements than the proposed rule, such as a higher flux index limit, or different requirements for certain shapes and sizes of magnets. This could reduce the costs associated with a rule by allowing firms to market a wider variety of products than under the proposed rule. However, for this alternative to reduce costs, it would allow more products to remain on the market, thereby decreasing the safety benefits.

Safety messaging requirements are another alternative to the proposed rule. This would reduce the costs associated with the rule because it would not require modifying or discontinuing subject magnet products, and the costs of warnings and instructional information likely would be small. However, this alternative is not likely to adequately reduce the risk of injury and death associated with magnet ingestions because the effectiveness of safety messaging depends on consumers seeing the messaging and being convinced to avoid the hazard. Incident data indicate that children commonly access ingested magnets from sources that are unlikely to include the product packaging bearing instructions or warnings. Moreover, consumers are unlikely to consistently heed warnings because of the perception that subject magnet products are appropriate for children, and underappreciation of the magnet ingestion hazard. Safety

messaging is generally considered the least effective way to address product hazards, and has been ineffective at addressing the magnet ingestion hazard, to date.

Another alternative is to require special packaging to limit children's access to subject magnet products. Such packaging could help consumers determine if all magnets have been returned to the container and include child-resistant features. Although this alternative would create some packaging costs, those likely would be lower than the costs associated with the proposed rule because it would allow subject magnet products to remain unchanged. However, this alternative is not likely to adequately reduce the risk of injury and death associated with magnet ingestions. For packaging requirements to be effective, users would have to repackage all magnets after each use, which is unlikely given the size and number of magnets in a product, the potential to lose magnets, and consumers' demonstrated underappreciation of the hazard. In addition, packaging is unlikely to be effective because it generally only restricts young children (under 5 years old) from accessing package contents, and would not prevent older children or teens from accessing the package contents, although the majority of magnet ingestion incidents involved children 5 years and older.

Another alternative is to require subject magnet products to be coated with aversive agents. This alternative would reduce the costs associated with the rule because it would allow firms to continue to sell subject magnet products and the costs of such coatings likely would be small. However, such requirements are not likely to adequately reduce the risk of injury and death associated with magnet ingestions because they do not address ingestions that occur when the first magnet is placed in the victim's mouth, before the aversive agent is detected, accidental ingestions, or children who are developmentally inclined to place objects in their mouths.

Another alternative is to provide a longer effective date for the final rule. This may reduce the costs associated with the rule by spreading them over a longer period, but it would also delay the safety benefits of the rule.

E. Unreasonable Risk

To issue a final rule, the CPSA requires the Commission to find that the rule, including the effective date, is reasonably necessary to eliminate or reduce an unreasonable risk of injury associated with the product. Factors the Commission considered with respect to this preliminary finding include the likelihood and severity of the risk, and the potential costs and benefits associated with the proposed rule.

As described above, there were an estimated 23,700 magnet ingestions treated in U.S. hospital EDs from January 1, 2010 to December 31, 2020. Although this includes ingestions of all magnet types, and is not limited to subject magnet products, it provides an indication of the frequency with which children and teens ingest magnets, and the need to address the magnet ingestion hazard. Of these estimated 23,700 ED-treated magnet ingestions, an estimated 4,400 involved products categorized as being used for amusement or jewelry, which are the products subject to this rule, and an additional estimated 18,100 involved unidentified magnet product types. As discussed with respect to the finding regarding the degree and nature of the risk of injury, a large portion of the incidents involving unidentified magnet products likely involve subject magnet products. In addition, the ICM projects that there were an additional estimated 3,255 magnet ingestion injuries per year treated in medical settings other than EDs from 2017 through 2020. Trend analysis indicates that magnet ingestions have significantly increased in recent years.

The potential injuries when a person ingests one or more magnets are serious. Health threats posed by magnet ingestion include pressure necrosis, volvulus, bowel obstruction, bleeding, fistulae, ischemia, inflammation, perforation, peritonitis, sepsis, ileus, ulceration, aspiration, and death, among others. These conditions can result from magnets attracting to each other through internal body tissue, or a single magnet attracting to a ferromagnetic object. One indication of the potential severity of magnet ingestions is hospitalization rates. Considering NEISS data, approximately 18 percent of estimated ED-treated magnet ingestions result in hospitalization. Of the 284 CPSRMS magnet ingestion cases, approximately twice as many resulted in hospitalization as other non-hospitalization treatment (187 hospitalizations, 94 other treatments). For subject magnet products, in particular, hospitalization was two to three times as common as other treatments. Specifically, for magnet set ingestions, 88 resulted in hospitalization and 46 resulted in other treatment; for magnet toys, 36 resulted in hospitalization and 13 resulted in other treatment; and for jewelry, 21 resulted in hospitalization, and 10 resulted in other treatment.

Another clear indication of the severity of health risks are fatal incidents. Staff identified five fatal magnet ingestion incidents that occurred in the United States between November 24, 2005 and January 5, 2021.¹⁰³ All of these incidents involved victims who died from injuries resulting from internal interaction of the magnets. Four of the five incidents involved children 2 years old or younger (the additional death involved an adult). At least one of these fatal incidents involved a magnet set, one involved an amusement product, and two fatal incidents provided product descriptions consistent with subject magnet products.

¹⁰³ CPSC is also aware of two deaths in other countries, which involved ingestion of hazardous magnets. Although staff does not know the specific products involved in these incidents, the magnets were similar, if not identical to magnets typically found in magnet sets.

CPSC staff estimates that the rule could result in aggregate benefits of about \$80 million to \$95 million annually; this estimate excludes magnet ingestion incidents involving unidentified magnet products, which are likely to commonly involve subject magnet products, making the benefits of the rule substantially greater. CPSC staff estimates that the costs to consumers and manufacturers associated with the rule could range from \$10 million to \$17.5 million annually, assuming annual sales of 500,000 units.

For these reasons, the Commission concludes preliminarily that ingestion of subject magnet products poses an unreasonable risk of injury and finds that the proposed rule is reasonably necessary to reduce that unreasonable risk of injury.

F. Public Interest

To issue a final rule, the CPSA requires the Commission to find that issuing the rule is in the public interest. This proposed rule is intended to address an unreasonable risk of injury and death posed by magnet ingestions. The Commission believes that compliance with the requirements of the proposed rule will significantly reduce magnet ingestion deaths and injuries in the future; thus, the rule is in the public interest.

G. Voluntary Standards

To issue a final rule, the CPSA requires the Commission to find that, if a voluntary standard addressing the risk of injury has been adopted and implemented, that either compliance with the voluntary standard is not likely to result in the elimination or adequate reduction of the risk or injury, or there is unlikely to be substantial compliance with the voluntary standard.

The Commission is aware of six voluntary and international standards that address the magnet ingestion hazard: ASTM F963-17, *Standard Consumer Safety Specification for Toy Safety*; ASTM F2923-20, *Standard Specification for Consumer Product Safety for Children's*

Jewelry; ASTM F2999-19, *Standard Consumer Safety Specification for Adult Jewelry*; ASTM F3458-21, *Standard Specification for Marketing, Packaging, and Labeling Adult Magnet Sets Containing Small, Loose, Powerful Magnets (with a Flux Index $\geq 50 \text{ kG}^2 \text{ mm}^2$)*; EN-71-1: 2014, *Safety of Toys; Part 1: Mechanical and Physical Properties*; and ISO 8124-1: 2018, *Safety of Toys — Part 1: Safety Aspects Related to Mechanical and Physical Properties*. The Commission does not consider the standards likely to result in an adequate reduction of the risk of injury associated with magnet ingestions because of the scope of products each standard covers, and the types of requirements included in them.

None of these standards apply to all of the products most commonly identified in magnet ingestion incidents—magnet sets intended for users 14 years and older, magnet toys intended for users 14 years and older, and jewelry. Moreover, even for the products the standards do address, several standards provide exceptions for certain amusement and jewelry products, imposing only warning requirements for those products.

In addition, several of the standards do not impose performance requirements on magnets themselves, such as size and strength requirements, instead recommending or requiring safety messaging or packaging. CPSC does not consider safety messaging or packaging requirements sufficient, without additional performance requirements, to adequately reduce the risk of injury and death associated with magnet ingestions. Incident data indicate that children commonly access ingested magnets from sources that do not include packaging or safety messaging; children and caregivers have commonly disregarded safety messaging to date; safety packaging only limits young children from accessing its contents, which does not address the majority of magnet ingestions, which involve older children and teens; and safety packaging requires users

to repackage all magnets after every use to be effective, which is unlikely given the large number and small size of magnets often in subject magnet products.

H. Relationship of Benefits to Costs

On a per unit basis (as shown in Table 19), CPSC estimates the expected benefits per unit to range from \$160 (assuming a 1.5-year product life and a 3 percent discount rate) to \$190 (assuming a 3-year product life and a 3 percent discount rate). The estimated expected cost to manufacturers per unit is between about \$5 and \$10, and there is an unquantifiable cost to consumers associated with lost utility and availability.

CPSC estimates the aggregate benefits of the rule to be \$80 million to \$95 million annually and estimates the cost of the rule to be between \$10 million to \$17.5 million annually, assuming sales of 500,000 units annually (estimated costs range from \$5 million to \$35 million annually, depending on annual sales between 250,000 and 1 million units). The Commission believes, preliminarily, that the benefits expected from the proposed rule bear a reasonable relationship to its costs.

I. Least Burdensome Requirement That Would Adequately Reduce the Risk of Injury

CPSC considered several less-burdensome alternatives to the proposed rule. One alternative is to take no regulatory action and, instead, rely on existing standards to address the magnet ingestion hazard. This would reduce the burden associated with the rule by avoiding a mandatory standard; however, this alternative is unlikely to adequately address the magnet ingestion hazard because none of the existing standards apply performance requirements to all of the products most commonly involved in magnet ingestions incidents.

Another alternative is a mandatory standard with less stringent requirements than the proposed rule, such as a higher flux index limit, or different requirements for certain shapes and

sizes of magnets. This could reduce the burden associated with a rule by allowing firms to market a wider variety of products than under the proposed rule. However, this alternative would reduce the safety benefits because allowing certain hazardous magnets in subject magnet products to remain on the market does not address the hazard such products pose.

Safety messaging is another alternative to the proposed rule. This alternative would reduce the burdens associated with the rule because it would not require modifying or discontinuing subject magnet products, and the costs of such warnings and instructional information likely would be small. However, this alternative is not likely to adequately reduce the magnet ingestion hazard. Safety messaging is generally the least effective way to reduce hazards associated with consumer products; incident data shows children commonly access ingested magnets from sources that do not include product packaging, where warnings are provided; incident data, behavioral and developmental factors, and other information indicate that children and caregivers commonly disregard safety messaging regarding the magnet ingestion hazard; and this approach has not been effective at adequately reducing the hazard, to date.

Another alternative is to require special packaging to limit children's access to subject magnet products. Such packaging could help consumers determine if all magnets have been returned to the container and include child-resistant features. Although this alternative would create some packaging costs, those costs likely would be lower than the proposed rule because it would allow subject magnet products to remain unchanged. However, this alternative is not likely to adequately reduce the risk of injury and death associated with magnet ingestions. Consumers are unlikely to repackage all magnets after each use, given the small size and large number of magnets in products, the potential to lose magnets, and consumers' demonstrated

underappreciation of the hazard. In addition, packaging requirements are unlikely to be effective because they generally only restrict young children (under 5 years old) from accessing package contents, and would not prevent older children or teens from accessing the package contents, although the majority of magnet ingestion incidents involved children 5 years and older.

Another alternative is to require subject magnet products to be coated with aversive agents. This alternative would reduce the burden associated with the rule because it would allow firms to continue to sell subject magnet products and the costs of such coatings likely would be small. However, such requirements are not likely to adequately address the hazard because they do not address ingestions that occur when the first magnet is placed in the victim's mouth, before the aversive agent is detected, accidental ingestions, or children who are developmentally inclined to place objects in their mouths.

Another alternative is to provide a longer effective date for the final rule. This may reduce the burdens associated with the rule by spreading them over a longer period, but it would also delay the safety benefits of the rule.

XVII. Request for Comments

The Commission requests comments on all aspects of the proposed rule. Comments should be submitted in accordance with the instructions in the **ADDRESSES** section at the beginning of this notice. The following are specific comment topics that the Commission would find helpful:

A. Scope and Definitions

- The scope of products covered by the proposed rule, and whether additional products should be included or excluded from the scope;
- Specifically, whether home/kitchen magnets or education products should be addressed in the rule;
- Data supporting any recommendations to include or exclude products from the scope of the rule; and
- Information and data about magnets involved in ingestion incidents that are categorized as unidentified product types in staff's analysis.

B. Performance Requirements

- Application of the ASTM F963 test method for measuring flux density, particularly to test small diameter spherical magnets in the 2 to 3 mm diameter range;
- Variances in flux density measurements of small spherical magnets, including correct identification of pole surfaces, accurate measurement of maximum absolute flux density, and accurate calculation of maximum cross section of the magnetic poles;
- Potential alternative methods of assessing the strength of magnets or their ability to cause internal interaction injuries;
- How many magnets should be tested, including whether all loose or separable magnets in subject magnet products should be tested, or only a representative sample or at least one representative sample of each shape and size should be tested, and how firms may satisfy such requirements;

- Whether statistical sampling should be used to determine how many magnets to test in a subject magnet product and to reasonably verify the tested sample is representative, particularly for products made up of numerous individual magnets;
- The proposed flux index limit of $50 \text{ kG}^2 \text{ mm}^2$, including data on whether magnets with flux indexes less than $50 \text{ kG}^2 \text{ mm}^2$ pose concern for the internal interaction hazard; and
- Whether the rule should include requirements similar to ASTM F963 to ensure that products do not liberate hazardous magnets after use and abuse testing.

C. Safety Messaging and Packaging Requirements

- Whether the rule should include requirements for safety messaging, particularly for products with flux indexes within the permissible range for which there is uncertainty about the flux indexes that can cause internal interaction hazards;
- Whether the rule should include requirements for packaging, particularly for products with flux indexes within the permissible range for which there is uncertainty about the flux indexes that can cause internal interaction hazards;
- What safety messaging requirements should include, and why they should be included; and
- What packaging requirements should include, and why they should be included.

D. Existing Standards

- Data regarding the level of compliance with existing standards that address magnet ingestions, including ASTM standards.

E. Economic Analysis (Preliminary Regulatory Analysis and IRFA)

- The estimates and other valuations used in CPSC's analysis regarding benefits and costs associated with the proposed rule;

- The annual unit sales of subject magnet products;
- The expected product life of subject magnet products;
- The number of subject magnet products subject to the proposed rule;
- The accuracy and reasonableness of the benefits estimates;
- Information about the costs to consumers associated with the proposed rule, including consumer needs for subject magnet products, and the potential impact of the proposed rule on the utility, cost, and availability of subject magnet products for those needs;
- The accuracy and reasonableness of the cost estimates for manufacturers and importers (if available, sales or other shipment data would be helpful);
- The potential impact of the proposed rule on small entities;
- Costs associated with testing and certification requirements, including requirements in section 14 of the CPSA, particularly for small businesses;
- Potential modifications to subject magnet products to comply with the proposed rule, and the costs associated with those modifications;
- The types and magnitude of manufacturing costs that might disproportionately impact small businesses or were not considered in the agency's analysis;
- The different impacts on small businesses associated with different effective dates; and
- Other alternatives that would minimize the impact on small businesses while reducing the magnet ingestion hazard.

F. Effective Date

- The reasonableness of the proposed 180-day effective date and recommendations for a different effective date, if justified. Comments recommending a longer effective date

should describe the problems associated with meeting the proposed effective date and the justification for a longer one.

G. Anti-Stockpiling

- Whether the Commission should consider including in the rule anti-stockpiling provisions to prevent manufacturing or importing of non-compliant subject magnet products at an increased rate during the period between announcing a final rule and the effective date of the rule; and
- Information relevant to whether an anti-stockpiling provision is necessary.

XVIII. Promulgation of a Final Rule

Section 9(d)(1) of the CPSA requires the Commission to promulgate a final consumer product safety rule within 60 days of publishing a proposed rule. 15 U.S.C. 2058(d)(1).

Otherwise, the Commission must withdraw the proposed rule if it determines that the rule is not reasonably necessary to eliminate or reduce an unreasonable risk of injury associated with the product, or is not in the public interest. *Id.* However, the Commission can extend the 60-day period, for good cause shown, if it publishes the reasons for doing so in the **Federal Register**. *Id.*

The Commission finds that there is good cause to extend the 60-day period for this rulemaking. Under both the Administrative Procedure Act and the CPSA, the Commission must provide an opportunity for interested parties to submit written comments on a proposed rule. 5 U.S.C. 553; 15 U.S.C. 2058(d)(2). The Commission typically provides 75 days for interested parties to submit written comments. A shorter comment period may limit the quality and utility of information CPSC receives in comments, particularly for areas where it seeks data and other detailed information that may take time for commenters to compile. In addition, the CPSA requires the Commission to provide interested parties with an opportunity to make oral

presentations of data, views, or arguments. 15 U.S.C. 2058. This requires time for the Commission to arrange a public meeting for this purpose, and provide notice to interested parties in advance of that meeting. After receiving written and oral comments, CPSC staff must have time to review and evaluate those comments.

These factors make it impractical for the Commission to issue a final rule within 60 days of this proposed rule. Moreover, issuing a final rule within 60 days of the NPR may limit commenters' ability to provide useful input on the rule, and CPSC's ability to evaluate and take that information into consideration in developing a final rule. Accordingly, the Commission finds that there is good cause to extend the 60-day period.

XIX. Conclusion

For the reasons stated in this preamble, the Commission proposes requirements for subject magnet products to address an unreasonable risk of injury associated with ingestion of such products.

List of Subjects

16 CFR Part 1112

Administrative practice and procedure, Audit, Consumer protection, Reporting and recordkeeping requirements, Third-party conformity assessment body.

16 CFR Part 1262

Consumer protection, Imports, Incorporation by reference, Safety.

For the reasons discussed in the preamble, the Commission proposes to amend Title 16 of the Code of Federal Regulations as follows:

PART 1112—REQUIREMENTS PERTAINING TO THIRD PARTY CONFORMITY ASSESSMENT BODIES

1. The authority citation for part 1112 continues to read as follows:

Authority: Pub. L. 110-314, section 3, 122 Stat. 3016, 3017 (2008); 15 U.S.C. 2063.

2. Amend § 1112.15 by adding paragraph (b)(55) to read as follows:

§ 1112.15 When can a third party conformity assessment body apply for CPSC acceptance for a particular CPSC rule or test method?

* * * * *

(b) * * *

(55) 16 CFR part 1262, Safety Standard for Magnets.

* * * * *

3. Add part 1262 to read as follows:

PART 1262—SAFETY STANDARD FOR MAGNETS

Sec.

1262.1 Scope, purpose, application, and exemptions.

1262.2 Definitions.

1262.3 Requirements.

1262.4 Test procedure for determining flux index.

1262.5 Findings.

Authority: 15 U.S.C. 2056, 2058

§ 1262.1 Scope, purpose, application, and exemptions.

(a) *Scope and purpose.* This part 1262, a consumer product safety standard, prescribes the safety requirements for a *subject magnet product*, as defined in 1262.2(b). These requirements are intended to reduce or eliminate an unreasonable risk of death or injury to consumers who ingest one or more *hazardous magnets* (as defined in 1262.2(a)) from a *subject magnet product*.

(b) *Application.* Except as provided in paragraph (c) of this section, all *subject magnet products* that are manufactured in the United States, or imported, on or after [effective date], are subject to the requirements of this part 1262, if they are *consumer products*. Section 3(a)(1) of the Consumer Product Safety Act (15 U.S.C. 2052(a)(1)) defines the term *consumer product* as an “article, or component part thereof, produced or distributed (i) for sale to a consumer for use in or around a permanent or temporary household or residence, a school, in recreation, or otherwise, or (ii) for the personal use, consumption or enjoyment of a consumer in or around a permanent or temporary household or residence, a school, in recreation, or otherwise.” The term does not include products that are not customarily produced or distributed for sale to, or for the use or consumption by, or enjoyment of, a consumer.

(c) *Exemptions.* Toys that are subject to 16 CFR part 1250, *Safety Standard Mandating ASTM F963 for Toys*, are exempt from this part 1262.

§ 1262.2 Definitions.

In addition to the definitions given in section 3 of the Consumer Product Safety Act (15 U.S.C. 2052), the following definitions apply for purposes of this part 1262:

(a) *Hazardous magnet* means a magnet that fits entirely within the cylinder described in 16 CFR 1501.4 and that has a flux index of $50 \text{ kG}^2 \text{ mm}^2$ or more when tested in accordance with the method described in this part 1262.

(b) *Subject magnet product* means a consumer product that is designed, marketed, or intended to be used for entertainment, jewelry (including children’s jewelry), mental stimulation, stress relief, or a combination of these purposes, and that contains one or more loose or separable magnets.

§ 1262.3 Requirements.

Each loose or separable magnet in a *subject magnet product* that fits entirely within the cylinder described in 16 CFR 1501.4 must have a flux index of less than 50 kG² mm² when tested in accordance with the method described in 1262.4.

§ 1262.4 Test procedure for determining flux index.

(a) Select at least one loose or separable magnet of each shape and size in the *subject magnet product*.

(b) Measure the flux index of each selected magnet in accordance with the procedure in section 8.25.1 through 8.25.3 of ASTM F963-17, *Standard Consumer Safety Specification for Toy Safety*, approved on May 1, 2017. The Director of the Federal Register approves this incorporation by reference in accordance with 5 U.S.C. 552(a) and 1 CFR part 51. You may obtain a copy from ASTM International, 100 Barr Harbor Drive, PO Box C700, West Conshohocken, PA 19428-2959; phone: (610) 832-9585; www.astm.org. A read-only copy of the standard is available for viewing on the ASTM website at <https://www.astm.org/READINGLIBRARY/>. You may inspect a copy at the Division of the Secretariat, U.S. Consumer Product Safety Commission, 4330 East West Highway, Bethesda, MD 20814, telephone (301) 504-7479, email: cpsc-os@cpsc.gov, or at the National Archives and Records Administration (NARA). For information on the availability of this material at NARA, email fr.inspection@nara.gov, or go to: www.archives.gov/federal-register/cfr/ibr-locations.html.

§ 1262.5 Findings.

(a) *General.* Section 9(f) of the Consumer Product Safety Act (15 U.S.C. 2058(f)) requires the Commission to make findings concerning the following topics and to include the findings in the rule. Because the findings are required to be published in the rule, they reflect the

information that was available to the Consumer Product Safety Commission (Commission, CPSC) when the standard was issued on [insert final rule publication date].

(b) *Degree and nature of the risk of injury.* The standard is designed to reduce the risk of death and injury associated with magnet ingestions. The Commission has identified 284 magnet ingestions that were reported to have occurred between January 1, 2010 and December 31, 2020. Seventy-five percent of these incidents involved amusement or jewelry products, which are the products covered by this rule, and an additional 15 percent involved unidentified magnet products, a large portion of which CPSC concludes are likely to have involved subject magnet products, based on developmental and behavioral factors, identified products involved in magnet ingestion incidents, products involved in recalls for magnet ingestion hazards, and trend analyses indicating a significant decrease in magnet ingestion incidents when there was a mandatory standard for certain subject magnet products. There were an estimated 4,400 magnet ingestions treated in U.S. hospital emergency departments between January 1, 2010 and December 31, 2020 that involved products categorized as being for amusement or jewelry, which are the products subject to this rule, and an additional estimated 18,100 emergency department treated magnet ingestions involving unidentified magnet products, a large portion of which CPSC concludes are likely to have involved subject magnet products for the reasons stated above. In addition, the Injury Cost Model projects that there were an additional estimated 3,255 magnet ingestion injuries per year treated in medical settings other than emergency departments from 2017 through 2020.

The potential injuries when a child or teen ingests one or more magnets are serious. Health threats posed by magnet ingestion include pressure necrosis, volvulus, bowel obstruction, bleeding, fistulae, ischemia, inflammation, perforation, peritonitis, sepsis, ileus, ulceration,

aspiration, and death, among others. These conditions can result from magnets attracting to each other through internal body tissue, or a single magnet attracting to a ferromagnetic object. CPSC is aware of several fatal magnet ingestion incidents that occurred in the United States, resulting from internal interaction of the magnets (small intestine ischemia and volvulus).

(c) *Number of consumer products subject to the rule.* Approximately 500,000 subject magnet products are estimated to be sold annually in the United States.

(d) *The need of the public for subject magnet products and the effects of the rule on their cost, availability, and utility.* Consumers use subject magnet products for entertainment, mental stimulation, stress relief, and jewelry. The proposed rule requires subject magnet products to meet performance requirements regarding size or strength, but does not restrict the design of products. As such, subject magnet products that meet the standard would continue to serve the purpose of amusement or jewelry for consumers. Magnets that comply with the proposed rule, such as non-separable magnets, larger magnets, weaker magnets, or non-permanent magnets, would likely still be useful for amusement or jewelry. However, it is possible that there may be some negative effect on the utility of subject magnet products if compliant products function differently or do not include certain desired characteristics.

Retail prices of subject magnet products generally average under \$20. CPSC has identified subject magnet products that comply with the proposed rule, indicating that the cost of compliant and non-compliant products are comparable.

If the costs associated with redesigning or modifying subject magnet products to comply with the proposed rule results in manufacturers discontinuing products, there may be some loss in availability to consumers. However, this would be mitigated to the extent that compliant products meet the same consumer needs.

(e) *Other means to achieve the objective of the rule while minimizing adverse effects on competition, manufacturing, and commercial practices.* The Commission considered several alternatives to achieve the objective of reducing unreasonable risks of injury and death associated with magnet ingestions. One alternative is to take no regulatory action and, instead rely on existing voluntary standards to address the magnet ingestion hazard. This would eliminate costs associated with the rule by avoiding a mandatory standard; however, this alternative is unlikely to adequately reduce the risk of injury and death associated with magnet ingestions. For one, none of the existing standards address all of the products most commonly identified in magnet ingestion incidents, and several of the standards provide exceptions to performance requirements for certain subject magnet products. In addition, under the existing standards, certain subject magnet products would not be subject to performance requirements regarding size and strength, instead relying on alternative requirements, such as safety messaging, which is unlikely to adequately reduce the magnet ingestion hazard.

Another alternative is a mandatory standard with less stringent requirements than the proposed rule, such as a higher flux index limit, or different requirements for certain shapes and sizes of magnets. This could reduce the costs associated with a rule by allowing firms to market a wider variety of products than under the proposed rule. However, for this alternative to reduce costs, it would allow more products to remain on the market, thereby decreasing the safety benefits.

Safety messaging requirements are another alternative to the proposed rule. This would reduce the costs associated with the rule because it would not require modifying or discontinuing subject magnet products, and the costs of warnings and instructional information likely would be small. However, this alternative is not likely to adequately reduce the risk of injury and death

associated with magnet ingestion because the effectiveness of safety messaging depends on consumer seeing the messaging and convincing them to avoid the hazard. Incident data indicate that children commonly access ingested magnets from sources that are unlikely to include the product packaging bearing instructions or warnings. Moreover, consumers are unlikely to consistently heed warnings because of the perception that subject magnet products are appropriate for children, and underappreciation of the magnet ingestion hazard. Safety messaging is generally considered the least effective way to address product hazards, and has been ineffective at addressing the magnet ingestion hazard, to date.

Another alternative is to require special packaging to limit children's access to subject magnet products. Such packaging could help consumers determine if all magnets have been returned to the container and include child-resistant features. Although this alternative would create some packaging costs, those likely would be lower than the costs associated with the proposed rule because it would allow subject magnet products to remain unchanged. However, this alternative is not likely to adequately reduce the risk of injury and death associated with magnet ingestions. For packaging requirements to be effective, users would have to repackage all magnets after each use, which is unlikely given the small size and large number of magnets often in a product, the potential to lose magnets, and consumers' demonstrated underappreciation of the hazard. In addition, packaging requirements are unlikely to be effective because they generally only restrict young children (under 5 years old) from accessing package contents, and would not prevent older children or teens from accessing the package contents, although the majority of magnet ingestion incidents involved children 5 years and older.

Another alternative is to require subject magnet products to be coated with aversive agents. This alternative would reduce the costs associated with the rule because it would allow

firms to continue to sell subject magnet products and the costs of such coatings likely would be small. However, such requirements are not likely to adequately reduce the risk of injury and death associated with magnet ingestions because they do not address ingestions that occur when the first magnet is placed in the victim's mouth, before the aversive agent is detected, accidental ingestions, or children who are developmentally inclined to place objects, including unpalatable substances, in their mouths.

Another alternative is to provide a longer effective date for the final rule. This may reduce the costs associated with the rule by spreading them over a longer period, but it would also delay the safety benefits of the rule.

(f) *Unreasonable risk.* Incident data indicate that there were an estimated 23,700 magnet ingestions treated in U.S. hospital emergency departments from January 1, 2010 to December 31, 2020. Although this includes ingestions of all magnet types, and is not limited to subject magnet products, it provides an indication of the frequency with which children and teens ingest magnets, and the need to address the magnet ingestion hazard. Of these estimated 23,700 emergency department treated magnet ingestions, an estimated 4,400 involved products categorized as being for amusement or jewelry, which are the products subject to this rule, and an additional estimated 18,100 involved unidentified magnet product types. The Commission considers a large portion of the incidents involving unidentified magnet products to have been subject magnet products, based on the factors described above with respect to the finding regarding the degree and nature of the risk of injury. In addition, the Injury Cost Model projects that there were an additional estimated 3,255 magnet ingestion injuries per year treated in medical settings other than emergency departments from 2017 through 2020. Trend analysis indicates that magnet ingestions have significantly increased in recent years.

The potential injuries when a person ingests one or more magnets are serious. Health threats posed by magnet ingestion include pressure necrosis, volvulus, bowel obstruction, bleeding, fistulae, ischemia, inflammation, perforation, peritonitis, sepsis, ileus, ulceration, aspiration, and death, among others. These conditions can result from magnets attracting to each other through internal body tissue, or a single magnet attracting to a ferromagnetic object. Magnet ingestion incidents commonly result in hospitalization, particularly when subject magnet products are ingested. The Commission is aware of five fatal magnet ingestion incidents that occurred in the United States between November 24, 2005 and January 5, 2021. Four of these incidents involved children 2 years old or younger, and all five victims died from injuries resulting from internal interaction of the magnets. Four of the five incidents identified the products as magnet sets, amusement products, or described them as having characteristics that are consistent with subject magnet products.

For these reasons, the Commission preliminarily concludes that the rule is reasonably necessary to eliminate or reduce an unreasonable risk of injury associated with the product.

(g) *Public interest.* This rule is intended to address an unreasonable risk of injury and death posed by magnet ingestions. The Commission believes that compliance with the requirements of the rule will significantly reduce magnet ingestion deaths and injuries in the future; thus, the rule is in the public interest. For these reasons, the Commission preliminarily concludes that issuing the rule is in the public interest.

(h) *Voluntary standards.* The Commission is aware of six voluntary and international standards that address the magnet ingestion hazard: ASTM F963-17, *Standard Consumer Safety Specification for Toy Safety*; ASTM F2923-20, *Standard Specification for Consumer Product Safety for Children's Jewelry*; ASTM F2999-19, *Standard Consumer Safety Specification for*

Adult Jewelry; ASTM F3458-21, *Standard Specification for Marketing, Packaging, and Labeling Adult Magnet Sets Containing Small, Loose, Powerful Magnets (with a Flux Index $\geq 50 \text{ kG}^2 \text{ mm}^2$)*; EN-71-1: 2014, *Safety of Toys; Part 1: Mechanical and Physical Properties*; and ISO 8124-1: 2018, *Safety of Toys — Part 1: Safety Aspects Related to Mechanical and Physical Properties*. The Commission does not consider the standards likely to result in an adequate reduction of the risk of injury associated with magnet ingestions because of the scope of products each standard covers, and the types of requirements included in them.

None of these standards apply to all of the products most commonly identified in magnet ingestion incidents—magnet sets intended for users 14 years and older, magnet toys intended for users 14 years and older, and jewelry. Even for the products the standards do address, several standards provide exceptions for certain amusement and jewelry products, imposing only warning requirements for those products.

In addition, several of the standards do not impose performance requirements on magnet themselves, such as size and strength requirements, instead recommending or requiring safety messaging or packaging. CPSC does not consider safety messaging or packaging requirements sufficient, without additional performance requirements, to adequately reduce the risk of injury and death associated with magnet ingestions. Incident data indicate that children commonly access ingested magnets from sources that do not include packaging or safety messaging; children and caregivers have commonly disregarded safety messaging to date; safety packaging only limits young children (typically, children under 5 years old) from accessing its contents, which does not address magnet ingestions by older children and teens, which make up the majority of incidents; and safety packaging requires users to repackage all magnets after every

use to be effective, which is unlikely given the large number and small size of magnets often in subject magnet products.

For these reasons, the Commission preliminarily concludes that compliance with existing standards is not likely to result in the elimination or adequate reduction of the risk of injury associated with magnet ingestion.

(i) *Relationship of benefits to costs.* CPSC estimates the aggregate benefits of the rule to be \$80 million to \$95 million annually and estimates the cost of the rule to be between \$10 million to \$17.5 million annually, assuming sales of 500,000 units annually (estimated costs range from \$5 million to \$35 million annually, depending on annual sales between 250,000 and 1 million units).

On a per unit basis, CPSC estimates the expected benefits per unit to range from \$160 (assuming a 1.5-year product life and a 3 percent discount rate) to \$190 (assuming a 3-year product life and a 3 percent discount rate). The estimated expected cost to manufacturers per unit is between about \$5 and \$10, and there is an unquantifiable cost to consumers associated with lost utility and availability.

Based on this analysis, the Commission preliminarily finds that the benefits expected from the rule bear a reasonable relationship to its anticipated costs.

(j) *Least burdensome requirement that would adequately reduce the risk of injury.* CPSC considered several less-burdensome alternatives to the proposed rule. One alternative is to take no regulatory action and, instead, rely on existing standards to address the magnet ingestion hazard. This would reduce the burden associated with the rule by avoiding a mandatory standard, however, this alternative is unlikely to adequately address the magnet ingestion hazard because

none of the existing standards apply performance requirements to all of the products most commonly involved in magnet ingestions incidents.

Another alternative is a mandatory standard with less stringent requirements than the proposed rule, such as a higher flux index limit, or different requirements for certain shapes and sizes of magnets. This could reduce the burden associated with a rule by allowing firms to market a wider variety of products than under the proposed rule. However, this alternative would reduce the safety benefits because allowing certain hazardous magnets in subject magnet products to remain on the market does not address the hazard such products pose.

Safety messaging is another alternative to the proposed rule. This alternative would reduce the burdens associated with the rule because it would not require modifying or discontinuing subject magnet products, and the costs of such warnings and instructional information likely would be small. However, this alternative is not likely to adequately reduce the magnet ingestion hazard. Safety messaging is generally the least effective way to reduce hazards associated with consumer products; incident data shows children commonly access ingested magnets from sources that do not include product packaging, where warnings are provided; incident data, behavioral and developmental factors, and other information indicate that children and caregivers commonly disregard safety messaging regarding the magnet ingestion hazard; and this approach has not been effective at adequately reducing the hazard, to date.

Another alternative is to require special packaging to limit children's access to subject magnet products. Such packaging could help consumers determine if all magnets have been returned to the container and include child-resistant features. Although this alternative would create some packaging costs, those costs likely would be lower than the proposed rule because it

would allow subject magnet products to remain unchanged. However, this alternative is not likely to adequately reduce the risk of injury and death associated with magnet ingestions. Consumers are unlikely to repackage all magnets after each use, given the small size and large number of magnets in products, the potential to lose magnets, and consumers' demonstrated underappreciation of the hazard. In addition, packaging requirements would only prevent young children (typically, children under 5 years old) from accessing the product, not older children or teens, who are involved in the majority of magnet ingestion incidents.

Another alternative is to require subject magnet products to be coated with aversive agents. This alternative would reduce the burden associated with the rule because it would allow firms to continue to sell subject magnet products and the costs of such coatings likely would be small. However, such requirements are not likely to adequately address the hazard because they do not address ingestions that occur when the first magnet is placed in the victim's mouth, before the aversive agent is detected, accidental ingestions, or children who are developmentally inclined to place objects in their mouths.

Another alternative is to provide a longer effective date for the final rule. This may reduce the burdens associated with the rule by spreading them over a longer period, but it would also delay the safety benefits of the rule.

For these reasons, the Commission preliminarily finds that the rule imposes the least burdensome requirement that prevents or adequately reduces the risk of injury associated with magnet ingestions.

Alberta E. Mills,

DRAFT

*Secretary,
Consumer Product Safety Commission.*



Staff Briefing Package

Draft Notice of Proposed Rulemaking for Hazardous Magnet Products

October 6, 2021

Table of Contents

Executive Summary	iii
Briefing Memorandum.....	1
I. Introduction.....	2
A. Product	3
B. Background	5
II. Discussion.....	9
A. Incident Data	9
B. Assessment of Existing Standards for Hazardous Magnets.....	16
C. Alternative Options to Reduce Risk.....	18
D. Recommendations	20
E. Economic Assessment of Draft Proposed Rule.....	25
F. Comments to Solicit.....	29
III. Conclusion.....	30
TAB A: Health Outcomes Following Exposure to Hazardous Magnets and Associated Medical Considerations.....	31
TAB B: NEISS Estimates and Analysis of CPSRMS Reported Incidents Related to Ingestion of Magnets.....	50
TAB C: Human Factors Assessment of Hazardous Magnet Products.....	65
TAB D: Recommended Performance Requirements to Address Ingestion Injuries Associated with Hazardous Magnets.....	105
TAB E: Preliminary Regulatory Analysis of a Draft Proposed Rule that Would Establish a Standard for Hazardous Magnet Products	123
TAB F: Initial Regulatory Flexibility Analysis of a Mandatory Rule that Would Establish a Standard for Hazardous Magnet Products	147
TAB G: Summary of Recalls Involving Small, Powerful Magnets January 1, 2010 through August 17, 2021	161

EXECUTIVE SUMMARY

Staff of the U.S. Consumer Product Safety Commission (CPSC) recommends addressing through rulemaking under sections 7 and 9 of the Consumer Product Safety Act (CPSA) the internal interaction hazard associated with the ingestion of small, powerful magnets (hazardous magnets) by children and teens. Hazardous magnets are small enough for children to swallow (*i.e.*, fit entirely within the small parts cylinder), and also strong enough to interact through body tissues, posing risks of death and acute- and long-term adverse health consequences. Staff estimates 23,700 emergency department-treated ingestions of magnets from January 1, 2010 through December 31, 2020. Data from NEISS, CPSRMS, and Poison Control Centers demonstrate magnet ingestions have risen considerably in recent years, after the 2014 rule on magnet sets (79 FR 59962) was vacated in November 2016. The internal interaction hazard posed by hazardous magnets has been well-documented for more than a decade by CPSC, foreign regulators, medical associations, and consumer advocacy groups.

As detailed in this package, staff analyzed magnet ingestion reports and investigated methods to address the internal interaction hazard. Among other factors, staff considered: hazard patterns in magnet ingestion incident data, child development, functional utility of hazardous magnets in consumer products, consumer reviews for products with loose or separable hazardous magnets, prohibitions in other countries pertaining to hazardous magnets, contributions from various stakeholders in the ASTM F15.77 subcommittee on magnets, and the available literature. Based on staff's findings, staff recommends mandating performance requirements for consumer products that include one or more magnets that are loose or separable, and designed, marketed, or intended to be used by consumers for entertainment, jewelry (including children's jewelry), mental stimulation, stress relief, or a combination of these purposes (subject magnet products). The subject magnet products do not include "children's toys" subject to the requirements in ASTM F963, *Standard Consumer Safety Specification for Toy Safety*, which is mandated by 16 CFR part 1250, or magnet products intended only for education and research (*e.g.*, science kits) and/or home and kitchen (*e.g.*, hardware magnets and refrigerator magnets) purposes. The draft proposed rule extends the magnet size and strength requirements established by ASTM F963 to the subject magnet products; specifically, under the draft proposed rule, any loose or separable magnets in the subject magnet products must meet the following criteria: (1) each magnet must be too large to fit entirely within the small parts cylinder described in 16 CFR 1501.4; or (2) each magnet must have a flux index of less than $50 \text{ kG}^2 \text{ mm}^2$, as measured by the procedures for determining the magnetic attractive force described in ASTM F963.

Based on staff's preliminary regulatory analysis, staff estimates that the benefits of the draft proposed rule may exceed the costs, so the benefits expected from the draft proposed rule bear a reasonable relationship to its costs. The benefits include reducing the risk of death and serious injury to children and teens, as reflected in the reduction in societal costs, which staff estimates to be about \$47.6 million annually during the 4-year period since the 2014 rule was vacated (2017–2020), excluding cases involving unidentified magnet products. The expected costs of the draft proposed rule would consist predominantly of the lost utility to consumers because they would no longer be able to purchase and use the subject magnet products, and the lost income of producers and sellers who would no longer be able to produce and sell the subject magnet products. Staff estimates the costs to range from \$10 million to \$17.5 million.

Staff's preliminary regulatory analysis also states that no standard was submitted to the Commission for consideration as a potential mandatory safety standard. CPSC did not receive any submissions identifying efforts to develop or modify a standard. Nevertheless, staff considered existing standards that address the magnet ingestion hazard to determine whether they are likely to adequately reduce the risk of injury. Staff assessed existing domestic standards pertaining to hazardous magnets in consumer products: one voluntary standard that has been adopted as a mandatory standard and three additional voluntary standards. Based on the existing data, staff supports the performance requirements for hazardous magnets specified in ASTM F963, and referenced in the other standards, for the full scope of products included in the draft proposed rule. Staff determined that none of the voluntary standards considered adequately addresses the risks of serious injuries and death because of limits in their scope of covered products and/or reliance on packaging, labeling, and warning requirements.

Staff considered various alternatives to reduce the risk of the internal interaction hazard, including safety messaging and special packaging, which are used in ASTM F3458 for adult magnet sets; aversive agents to deter ingestion; future ASTM activities; and performance requirements. Staff finds that these alternatives, without performance requirements for magnets themselves, are not likely to adequately reduce the risk of injury associated with magnet ingestions.

BRIEFING MEMORANDUM



**UNITED STATES
CONSUMER PRODUCT SAFETY COMMISSION
BETHESDA, MARYLAND 20814**

Date: October 6, 2021

TO: The Commission
Alberta E. Mills, Secretary

THROUGH: Pamela Stone, Acting General Counsel
Mary T. Boyle, Executive Director
DeWane Ray, Deputy Executive Director for Safety Operations

FROM: Duane E. Boniface, Assistant Executive Director
Office of Hazard Identification and Reduction

Stephen Harsanyi, Project Manager, Hazardous Magnet Products Project
Division of Human Factors, Directorate for Engineering Sciences

SUBJECT: Staff's Draft Notice of Proposed Rulemaking for Hazardous Magnet Products

I. Introduction

Staff of the U.S. Consumer Product Safety Commission (CPSC or Commission) is concerned about the large and continuing number of magnet ingestion incidents involving consumer products. The hazard pattern typically involves children and teens under 16 years of age accidentally ingesting magnets from consumer products, while using the magnets for amusement, such as fidgeting or playing, or simulating lip, tongue, and cheek studs/piercings. The majority of incidents with product-identifying information involve entertainment toys intended for users 14 years and older, particularly magnet sets, and products identified or described as jewelry, such as bracelets, necklaces, and faux piercings. If ingested, some small, powerful magnets (hazardous magnets) are strong enough to interact internally with one another, or with ferromagnetic objects (material attracted to magnets), through body tissue, and resist natural bodily forces to separate the magnets. This interaction has led to deaths and acute- and long-term adverse health consequences, typically by causing intestinal twisting (volvulus injuries), fistulae, and perforations.

This briefing package details staff's analysis of magnet ingestion injuries, staff's investigation of methods to address the internal interaction hazard involving children and teens, and staff's recommendations for effectively limiting or preventing the internal interaction hazard. Among other factors, staff considered: hazard patterns; child development; functional utility of hazardous magnets in products; consumer reviews for products with loose or separable hazardous magnets; prohibitions in other countries pertaining to hazardous magnets;

contributions from various stakeholders in the ASTM F15.77 subcommittee on magnets;¹ CPSC recall activity; and the available literature.

This briefing package also presents a preliminary regulatory analysis that discusses the potential benefits and costs of the draft proposed rule requirements, an evaluation of the relevant voluntary standards, a description of alternatives considered, and an initial regulatory flexibility analysis that discusses the potential impact of the draft proposed rule on small businesses.

A. Product

The subject magnet products include one or more magnets, which are loose or separable, and designed, marketed, or intended to be used by consumers for entertainment, jewelry (including children’s jewelry), mental stimulation, stress relief, or a combination of these purposes (purposes abbreviated below as “amusement or jewelry”). Examples of the subject magnet products include magnet sets intended for adults (users 14 years and older),² other types of magnet toys marketed to adults (such as other products commonly referred to as “executive toys” and “adult desk toys”), and jewelry with separable magnets (such as jewelry-making sets and magnetic piercings/studs). Jewelry with non-removable magnets, such as a necklace with a magnetic clasp, would not be considered a subject magnet product. Although most subject magnet products are intended for users 14 years or older, some subject magnet products, such as children’s jewelry, would be considered “children’s products.”³ Figure 1 below shows examples of some products considered in-scope of the draft proposed rule.



Figure 1. Examples of a magnet set executive desk toy (left), a decompression magnet pen toy (middle-left), rock magnet fidget toy (middle-right), and a magnetic jewelry set (right).

The subject magnet products do not include the following types of products:

- home and kitchen products, such as shower curtains and hardware, unless they meet the criteria for the subject magnet products;
- magnet products intended only for education and research, such as science kits for schools and universities; and

¹ CPSC staff participates in various ASTM International (ASTM) subcommittee meetings, including ASTM F15.77 on magnets. ASTM subcommittees consist of members who represent producers, users, consumers, government, and academia. ASTM International website: www.astm.org, About ASTM International.

² “Adults” is used in this package to refer to products intended for consumers ages 14 years and older, and therefore, not subject to the existing regulation for children’s toys (ASTM F963 mandated by 16 CFR part 1250); however, staff generally does not consider consumers under age 18 to be adults.

³ The Consumer Product Safety Act defines “children’s products” as products designed or intended primarily for children 12 years or younger. 15 U.S.C. 2052(a)(2).

- children’s toys subject to ASTM F963, *Standard Consumer Safety Specification for Toy Safety*.

Staff analyzed the incident data, behavioral patterns, and ability to access and use the products, and considered available literature, international actions, and stakeholder contributions through the voluntary standards process. Staff determined that the magnet products that are within the scope of the draft proposed rule carry the highest risk for children and teens in terms of ingestion-related outcomes.

Staff is concerned particularly about magnet sets, as their involvement in ingestion injuries is well-documented. Staff defines “magnet set” as an aggregation of separable magnetic objects that are marketed or commonly used as manipulative or construction items for entertainment, such as puzzle working, sculpture building, mental stimulation, or stress relief. These products often include hundreds to thousands of loose, hazardous magnets. In addition, many incidents involve products described as jewelry, such as bracelets, necklaces, and faux piercings/studs. These incidents show that children and teens commonly access and ingest magnets used as jewelry, and staff has determined that loose or separable hazardous magnets in jewelry are dangerous to these populations.

The magnets considered within the scope of the draft proposed rule are not limited by magnet composition. Staff has found that various magnet compositions have been involved in internal interaction incidents, such as Neodymium-Iron-Boron (NIB), typically found in the smaller magnets used in magnet sets and magnetic jewelry sets, and ferrite/hematite, as typically found in larger magnets, such as rock-shaped magnet toys (Figure 1). Staff found that 5 mm diameter NIB magnets (the most common size identified in magnet ingestion incidents) typically measure between 300 and 400 kG² mm², and ferrite rock magnets measured upwards of 700 kG² mm². Magnets involved in incidents include a variety of shapes, such as spheres, cubes, rods, and rocks, among others. It is important to note that most of the incident reports lack specific information pertaining to the shape, size, and composition of magnets involved in ingestion incidents, which is why strength and size requirements are the focus for limiting the capability of magnets from the subject magnet products to be ingested and result in internal interaction injuries.

The product scope includes individual magnets that are intended or marketed to be used with or as the subject magnet products. Discussed in the following section, this requirement for individual magnets is consistent with ASTM F963 (mandated by 16 CFR part 1250), which includes size and strength limits prohibiting one or more hazardous magnets in children’s toys (with few exemptions). Hazardous magnets used with or as the subject magnet products may be sold per-magnet, thereby necessitating a rule that applies to products with one or more than one magnet. Furthermore, an individual, hazardous magnet can interact internally through body tissue with an unrelated magnet or ferromagnetic object, such as certain hardware, and result in the internal interaction hazard.

B. Background

CPSC's Activities Pertaining to Hazardous Magnets

Since 2006, CPSC has drawn attention to the magnet internal interaction hazard associated with consumer products through safety alerts,⁴ recalls,⁵ and rulemaking activities. In 2007, CPSC staff worked with ASTM to address hazardous magnets in children's toys; requirements pertaining to these products are included in the voluntary standard for children's toys, ASTM F963.⁶ In 2008, the Consumer Product Safety Improvement Act (CPSIA) mandated that ASTM F963 would be considered a mandatory consumer product safety standard; the Commission codified this mandate in 16 CFR part 1250. In accordance with this mandate, children's toys must comply with ASTM F963 (current version is ASTM F963 – 17). Discussed in Tab D, ASTM F963 – 17 specifies that children's toys shall not contain a loose as-received hazardous magnet or a loose as-received hazardous magnetic component, and shall not liberate a hazardous magnet or hazardous magnetic component when tested in accordance with the standard.⁷ The standard identifies magnets and magnetic components as hazardous if they meet the following criteria: (1) small enough to fit entirely into the small parts cylinder,⁸ and (2) flux index equal to or greater than 50 kG² mm².

Since 2010, CPSC has received numerous incident reports involving children ingesting magnets from products intended for adults, particularly magnet sets, and therefore, products that are not subject to the requirements in ASTM F963. CPSC published a final rule for magnet sets (16 CFR part 1240) on October 3, 2014, which took effect on April 1, 2015 (79 FR 59962).⁹ The rule defined "magnet sets" as "aggregations of separable magnetic objects that are marketed or commonly used as a manipulative or construction item for entertainment, such as puzzle working, sculpture building, mental stimulation, or stress relief." The final rule addressed the hazards associated with magnet set ingestions, consistent with requirements in ASTM F963; in accordance with 16 CFR part 1240, each magnet in a magnet set, as well as individual magnets that were intended or marketed to be used with or as magnet sets, was required not to fit entirely

⁴ Example CPSC safety alert from 2007: <https://www.cpsc.gov/s3fs-public/5221.pdf>.

⁵ Example recall of children's magnetic building set with hazardous magnets: <https://www.cpsc.gov/Recalls/2007/magnetix-magnetic-building-set-recall-expanded-serious-injuries-continue-to-be-reported>.

⁶ ASTM F963 includes performance and safety messaging requirements for "children's toys," which are defined in the standard as objects designed, manufactured, or marketed as a plaything for children under 14 years of age.

⁷ Discussed in Tabs C and D, there is an exemption in the standard for magnetic/electrical experimental sets intended for children 8 years and older.

⁸ ASTM F963 – 17 provides a figure of the small parts cylinder, including dimensions, and refers to the identical CPSC small parts cylinder specified in 16 CFR part 1501—Method for Identifying Toys and Other Articles Intended for Use by Children Under 3 Years of Age Which Present Choking, Aspiration, or Ingestion Hazards Because of Small Parts.

⁹ Briefing Package: Final Rule on Safety Standard for Magnet Sets (2014): https://cpsc.gov/s3fs-public/pdfs/foia_SafetyStandardforMagnetSets-FinalRule.pdf.

within the small parts cylinder, or to have a flux index of 50 kG² mm² or less.¹⁰ On November 22, 2016, the U.S. Court of Appeals for the Tenth Circuit vacated and remanded the rule.¹¹

On August 17, 2017, a magnet set importer filed a petition with the CPSC, requesting that the Commission initiate rulemaking to establish mandatory standards for high-powered magnet sets. The petition stated that high-powered magnet sets present an internal injury risk to children if the high-powered magnets are “ingested, aspirated, or otherwise inserted into the . . . body.” The petition requested rulemaking under CPSA sections 7 and 9 (15 U.S.C. § 2056 and 15 U.S.C. § 2058). The Commission published a *Federal Register* notice on October 6, 2017, which requested public comments on the petition (82 FR 46740). The Petitioner withdrew the petition on April 22, 2020. Staff provided to the Commission on June 3, 2020, an informational briefing package that included staff’s work in response to the petition.¹² In the informational package, staff recommended continued consideration of performance requirements for magnet sets to effectively address ingestion of hazardous magnets by children and teens.

Since March 2019, staff has participated actively in the ASTM F15.77 subcommittee on magnets, which in March 2021, published a voluntary standard on “adult”¹³ magnet sets, F3458, *Standard Specification for Marketing, Packaging, and Labeling Adult Magnet Sets Containing Small, Loose, Powerful Magnets (with a Flux Index ≥ 50 kG² mm²)*. Despite staff’s efforts to include effective performance requirements in the standard, the subcommittee and greater ASTM F15 committee on consumer products ultimately decided to publish the standard with only safety messaging and packaging requirements. Staff voted against this decision, because staff has determined that performance requirements are necessary to adequately address the hazard. On May 25, 2021, the subcommittee voted in favor of forming a task group to develop effective performance requirements for adult magnet sets (15 members in favor, and 3 against). These efforts are ongoing, and include discussions of extending to certain magnet sets the magnet strength and size requirements specified in ASTM F963; however, the eventual outcome is uncertain in scope and timeline.

From 2006 through 2009, CPSC issued more than a dozen recalls of children’s toys due to the hazard involving small, powerful magnets not being adequately contained within children’s toys, making them accessible for children to swallow.¹⁴ In Tab G, Compliance staff provides a summary of CPSC’s recalls from January 1, 2010 through August 17, 2021, involving consumer products with hazardous magnets—a period approximately three times as long. This summary shows that the number of recalls involving children’s toys with hazardous magnets has fallen substantially. There were 18 consumer-level recalls in this 11-year timeframe, only four of

¹⁰ Prior to ASTM F963 – 16, magnets and magnetic components were identified in the standard as having a flux index “greater than” 50 kG² mm². This was changed in the 2016 version of the standard, and has since remained “greater than or equal to” 50 kG² mm².

¹¹ *Zen Magnets, LLC v. Consumer Product Safety Commission*, 841 F.3d 1141 (10th Cir. 2016).

¹² CPSC staff’s informational briefing package regarding magnet sets, “Staff Briefing Package in Response to Petition CP 17-1, Requesting Rulemaking Regarding Magnet Sets,” dated June 3, 2020: [https://cpsc.gov/s3fs-public/Informational Briefing Package Regarding Magnet Sets.pdf?FKVcZpHmPKWCZNb7JEl6Ir0a31WV72PI](https://cpsc.gov/s3fs-public/Informational%20Briefing%20Package%20Regarding%20Magnet%20Sets.pdf?FKVcZpHmPKWCZNb7JEl6Ir0a31WV72PI).

¹³ In general, CPSC considers “adults” to be age 18 years and older. However, ASTM refers to “adults” in ASTM F3458 to mean users age 14 years and older, because that is the intended user age that is not covered by ASTM F963.

¹⁴ Final decision and order, CPSC Docket No: 12-2: https://www.cpsc.gov/s3fs-public/pdfs/recall/lawsuits/abc/163--2017-10-26%20Final%20Decision%20and%20Order.pdf?Tme8u5fRF2.29_B.i4Ix7pPwb_WhKng2.

which involved children's toys; of those four recalls of children's toys, only two were recalled for violations of the magnet requirements in the toy standard. Thus, even over a significantly longer period, there were substantially fewer recalls of children's toys for violations of the magnet requirements. Staff finds that this is likely indicative of the success of the mandatory standard for children's toys in addressing the magnet ingestion hazard in toys, and also indicates that children's toys substantially comply with the F963 toy standard. In addition to these recalls, CPSC has investigated other hazardous magnet products, whose manufacturers chose to cease sales rather than perform recalls. Compliance staff remains active in addressing hazardous magnet products on a case-by-case basis.

Prohibitions of Hazardous Magnets in Other Countries

Foreign regulators acknowledge the seriousness of the internal interaction hazard posed by hazardous magnets in consumer products, including prohibitions specific to children's toys, as well as magnet sets, and in some countries, other types of products intended for amusement or jewelry. Staff agrees with the approach of addressing the hazard patterns, such as ingestion while playing with magnets and using magnets as jewelry.

Since 2006, Health Canada has issued several advisories to warn Canadian consumers of the dangers associated with ingesting magnets. Despite these warnings and some manufacturers' efforts to keep these products out of the hands of children, which have included package warnings, instructions on safe use, and guidance to retailers on safe selling practices, these magnets were accessed and used by children, and incidents continued to occur.^{15,16} Canada addresses the internal interaction hazard associated with hazardous magnets similarly to the requirements recommended in this package, as summarized below.¹⁷

1. Canada's Toys regulation SOR/2018-138 includes requirements for magnetic toys for use by children under 14 years of age.^{18,19} The requirements are consistent with ASTM F963, EN 71-1,²⁰ and ISO 8124-1,²¹ including the identification and prohibition of hazardous magnets and magnetic components, and the exemption for magnetic/electrical experimental sets. The regulation includes toys with only one magnet to account for attraction to ferromagnetic objects, such as most Canadian coins.

¹⁵ <https://www.canada.ca/en/health-canada/services/consumer-product-safety/advisories-warnings-recalls/letters-notices-information-industry/information-manufacturers-importers-distributors-retailers-products-containing-small-powerful-magnets.html>.

¹⁶ <https://healthycanadians.gc.ca/recall-alert-rappel-avis/hc-sc/2013/31619a-eng.php>.

¹⁷ Staff communicated with representatives from Health Canada's risk management bureau on July 7, 2021, to confirm staff's understanding of Canada's current requirements pertaining to hazardous magnets and Health Canada's justification for the requirements.

¹⁸ <https://laws-lois.justice.gc.ca/eng/regulations/SOR-2011-17/index.html>.

¹⁹ <https://canadagazette.gc.ca/rp-pr/p2/2018/2018-07-11/html/sor-dors138-eng.html>.

²⁰ EN 71-1:2014, *Safety of Toys – Part 1: Mechanical and Physical Properties*, is a European standard that applies to toys for children, with toys being any product or material designed or intended, whether or not exclusively, for use in play by children of less than 14 years (see Tab D).

²¹ ISO 8124-1:2018, *Safety of Toys – Part 1: Safety Aspects Related to Mechanical and Physical Properties*, is an international standard that applies to all toys, meaning any product or material designed or clearly intended for use in play by children under 14 years of age (see Tab D).

2. Canada’s general prohibition under the Canada Consumer Product Safety Act (CCPSA) includes separate requirements for products with hazardous magnets, which are not toys subject to SOR/2018-138.²² Paragraphs 7(a) and 8(a) of the CCPSA prohibit the manufacture, importation, advertisement, or sale of any consumer product that is a “danger to human health or safety.” The requirements are consistent with ASTM F963, EN 71-1, and ISO 8124-1, including the identification and prohibition of hazardous magnets and magnetic components. The scope of the requirement includes:
- Novelty magnet sets, where the set is intended to be manipulated by consumers for entertainment, such as puzzle working, sculpture building, mental stimulation or stress relief;
 - Magnet sets containing more than one small, powerful magnetic piece in spherical, cube, or cuboid shapes; and
 - Magnetic products with one or more magnets intended for entertainment or amusement of adults.

Australia has also taken efforts to address separately hazardous magnets in children’s toys and certain other products. Australia’s safety standard, AS/NZS ISO 8124.1, *Safety of Toys — Part 1: Safety Aspects Related to Mechanical and Physical Properties*, aligns with ASTM F963’s identification and prohibition of hazardous magnets in children’s toys for ages under 14 years. For products not covered by this safety standard, the Australian Competition & Consumer Commission (ACCC) issued a permanent ban on small, high-powered magnet toys and certain types of magnetic jewelry. The ban became effective on November 15, 2012, and remains in effect (Consumer Protection Notice No.5 of 2012).^{23,24} This ban focuses on separable or loose magnetic objects supplied in multiples of two or more, where the magnetic objects are, among other things, marketed by the supplier as, or supplied for use as, a toy, game, or puzzle (including, but not limited to, an adult desk toy; an educational toy or game; a toy, game, or puzzle for mental stimulation or stress relief), or a construction or modelling kit, or jewelry to be worn in or around the mouth or nose.

Similarly, New Zealand also uses this safety standard, AS/NZS ISO 8124.1, for prohibiting hazardous magnets in children’s toys. Additionally, New Zealand’s Minister of Consumer Affairs deemed small, high-powered magnets to be hazardous, issuing an Unsafe Goods Notice for magnet sets, which went into effect on January 24, 2013. This action was effective for 18 months and was subsequently converted into a permanent ban using language similar to Australia’s ban.^{25,26} The ban applies to the following products:

- The sale and supply of small, strong magnets sold in sets of 2 or more in situations where children are able to access them; and

²² Staff reviewed two documents from Health Canada, which explain Canada’s “Notice of Danger to Human Health or Safety Assessment for Products Containing Small Powerful Magnets.” These documents are available from Health Canada upon request.

²³ <https://www.productsafety.gov.au/bans/small-high-powered-magnets>.

²⁴ <https://www.legislation.gov.au/Details/F2012L02171>.

²⁵ <https://productsafety.tradingstandards.govt.nz/for-consumers/safety-with-specific-products/high-powered-magnets/>

²⁶ <https://www.consumer.org.nz/articles/high-powered-magnets-banned>

- New and second-hand small, high-powered magnets that are supplied, or offered or advertised for supply, in sets of 2 or more for personal use. Personal use includes magnet sets that form part of a toy, game or puzzle, construction or modelling kits, or jewelry that is worn around the nose or mouth.

The ban does not include hardware magnets (such as magnets used for mounting and fastening products), magnets used for teaching purposes by schools and universities, or those intended to become part of another product.

The European Commission also uses for children's toys the requirements specified in EN 71-1. Regarding general use products with hazardous magnets, there is no safety standard under the General Product Safety Directive that would target magnets; however, Member States' market surveillance authorities generally apply EN 71-1 when assessing the risk posed by products that are not marketed as children's toys but are intended for children, and this includes "adult" magnet sets, as they are often bought for and used by children, even if they are marketed as toys for adults.

II. Discussion

This package discusses staff's analysis of the incident data, assessment of existing mandatory and voluntary standards pertaining to hazardous magnets in consumer products, evaluation of options to address the hazard, and recommendations for addressing the hazard. These analyses are summarized below.

A. Incident Data

Types of Injuries

Tab A details the serious, adverse health outcomes associated with the magnet internal interaction hazard. There are a variety of health threats posed directly by magnet ingestion, including volvulus, bowel obstruction, bleeding, pressure necrosis, fistulae, ischemia, inflammation, perforation, peritonitis, sepsis, ileus, ulceration, aspiration, and death, among others. There are also health threats posed indirectly from magnet ingestion, through invasive and diagnostic medical procedures. Complications associated with surgery to treat magnet ingestion have included pancreatitis and further hospitalization, additional surgery to treat incisional hernia, and the need for a lifelong feeding tube, among others. Endotracheal general anesthesia may be required for surgical treatments of magnet ingestion. Possible complications associated with general anesthesia include nausea, vomiting, sore throat, dental damage, myocardial ischemia or infarction, heart failure, cardiac arrest, arrhythmia, atelectasis (lung collapse), aspiration, bronchospasm, neurological effects, and renal effects, among others.

In total, CPSC is aware of seven deaths involving the ingestion of hazardous magnets between November 24, 2005 and January 5, 2021. Five of these deaths occurred in the United States. In 2005, a 20-month-old child's death involved ingestion of magnets from a children's toy building

set with plastic-encased magnets; the product was later recalled.²⁷ In 2013, a 19-month-old child's death involved multi-colored, 5 mm diameter spherical magnets from an unidentified product. In 2018, a 2-year-old child's death involved multi-colored, 3-5 mm (estimated) diameter spherical magnets with indications that the product likely was a magnet set (*i.e.*, described as a magnet fidget toy building set). In 2020, a 43-year-old adult's death involved unknown magnets. In 2021, a 15-month-old-child's death involved a magnet set of an unknown brand. In addition, CPSC is aware of two deaths in other countries that involved ingestion of hazardous, 5 mm diameter, spherical NIB magnets. In Australia in 2011, an 18-month-old child's death involved a product that included indications that it may have been a magnet set; and in Poland in 2014, an 8-year-old child's death involved a product that appeared likely to be a magnet set. While only one of these seven incidents identifies explicitly that a magnet set was involved, most of these incidents identify products consistent with magnet sets, and staff finds it plausible that they would be subject to the draft proposed rule.

According to the data from CPSC's Consumer Product Safety Risk Management System (CPSRMS),²⁸ there were at least 124 incidents that resulted in some form of surgery (including laparoscopy, laparotomy, appendectomy, cecostomy, enterotomy, colostomy, cecectomy, gastrotomy, jejunostomy, resection, and transplant). At least 108 incidents involved internal interaction through body tissue. Symptoms related to magnet ingestion may be misattributed by victims, caregivers, and doctors to other causes, thereby delaying correct medical treatment. The symptoms are sometimes characterized as flu-like; including vomiting, fever, and abdominal pain, among others. Symptomatology following magnet ingestion has been mistaken for unrelated ailments, such as stomach viruses, ear infections, and bronchitis. As discussed in Tabs A and C, for various reasons, delays between ingestion event and correct treatment are common, sometimes spanning months, and requiring more severe medical interventions.

Magnet-Related Injury Trends and Estimates of Magnet Ingestions

Tab B provides descriptive and inferential statistics for magnet ingestion incidents. An estimated 23,700 magnet-related ingestions were treated in hospital emergency departments (ED) from January 1, 2010 through December 31, 2020, based on the 1,072 magnet ingestion case reports obtained through the National Electronic Injury Surveillance System (NEISS).²⁹ Of these estimated 23,700 magnet ingestions, staff estimates that 1,300 involved products excluded from the draft proposed rule (*i.e.*, educational/research products and home/kitchen products not intended for amusement or jewelry, and children's toys subject to ASTM F963). Excluding these out-of-scope ingestions, staff estimates 22,500 ingestions treated from 2010 through 2020,

²⁷ The children's toy associated with the death of the 20-month-old child in 2005 was recalled in 2006. See press release #06-127: <https://www.cpsc.gov/Recalls/2006/childs-death-prompts-replacement-program-of-magnetic-building-sets>.

²⁸ The CPSRMS data cover incident reports from consumers, doctors, retailers, manufacturers, and other sources. The reported incidents in the CPSRMS database do not provide a complete count of all incidents that occurred during the period of interest and cannot be used for statistical estimates. However, they do provide a minimum number for the incidents occurring during this period, and the reports generally provide more information about the incidents, involved products, and victims than reported in the NEISS data.

²⁹ Data from NEISS are based on a nationally representative probability sample of about 100 hospitals in the United States and its territories. NEISS data can be accessed from the CPSC webpage under the "Access NEISS" link at: <https://www.cpsc.gov/Research--Statistics/NEISS-Injury-Data>. The data for this package were extracted on January 8, 2021.

involved magnets for which the subject products could not be ruled out on a case-by-case basis. Of these estimated 22,500 ingestions, staff estimates that 18,000 resulted in victims being treated and at least initially released, and an estimated 4,200 resulted in victims being immediately hospitalized or transferred. Patients presenting to emergency departments and other hospitals for foreign body ingestion of magnets are often sent home initially after primary diagnostic procedures (such as x-rays) to monitor for natural passage of the magnets. The NEISS reports capture one part of the treatment process (the emergency department visit), and typically do not show information on treatment after the initial visit. Therefore, the number of victims ultimately hospitalized may be significantly higher than captured in the above estimates. Of the 22,500 ingestions after excluding known out-of-scope cases, an estimated 4,400 involved products identified or described for amusement and/or jewelry purposes, and an estimated 18,100 involved unidentified magnet products. Based on the magnet-related injury trends relative to the 2014 rule on magnet sets, and additional reasons discussed below, staff finds it likely that a substantial proportion of the magnet ingestion incidents in which there was insufficient information to identify the product, involved subject magnet products.

Staff considered as a potential indication of the effectiveness of the 2014 rule on magnet sets (79 FR 59962) the number of magnet ingestions estimated to have occurred relative to the years the rule was announced to the public (October 2014), in place (April 2015 – November 2016), and no longer active (November 2016 onward). Table 1 shows the estimated number of magnet-related ingestions (excluding known out-of-scope incidents) treated in hospital emergency departments in four, full-year periods: 2010 through 2013 (four years; prior to the announcement of the rule), 2014 through 2016 (three years; rule announced through year vacated), 2017 through 2020 (four years; after rule was vacated), and the total for the studied period (2010–2020). The middle three years (2014–2016) show significantly fewer overall ingestions compared with earlier and more recent years.

Table 1: Estimated Number of Magnet-Related Ingestions (excluding known out-of-scope) Treated in Hospital Emergency Departments by Period

Period	Annual average estimate	CV	N (not an average)	Years in period
2010 - 2013	2,300	0.16	395	4
2014 - 2016	1,300	0.20	200	3
2017 - 2020	2,300	0.15	419	4
2010 - 2020	2,000	0.14	1,014	11

Source: NEISS, CPSC; estimates rounded to nearest 100.

Staff identified similar results with the non-statistical (*i.e.*, anecdotal) CPSRMS-reported data (Table 2): of the CPSRMS-reported magnet ingestions from 2010 through 2020 (excluding known out-of-scope incidents), 47.5 percent of the ingestions occurred prior to the year the rule was announced (2010–2013); only about 6.6 percent of the ingestions occurred in the full-year period from rule announcement to removal (2014–2016); and about 45.9 percent of the ingestions occurred in the years since the removal (2017–2020).

Table 2: Number of CPSRMS-Reported Magnet Ingestions (excluding known out-of-scope) by Period

Period	Percent of total	N	Years in period
2010 - 2013	47.5%	122	4
2014 - 2016	6.6%	17	3
2017 - 2020	45.9%	118	4
2010 - 2020	100%	257	11

Source: CPSRMS, CPSC; percentages rounded to nearest tenth. CPSRMS reporting for the years 2019-2020 is ongoing, and counts for those years may increase as reporting continues.

Both the NEISS estimates and CPSRMS data show a strong relationship between magnet ingestions and the previous rule on magnet sets, demonstrating ingestions falling appreciably during the full years of the announcement, publication, and removal of the rule, before rising again appreciably in the years following the year the rule was vacated. Staff concludes that this likely demonstrates that the announcement and publication of the rule resulted in a substantial reduction in ingestions while it was active, and that the number of ingestions rose appreciably in recent years because the rule is no longer in effect.

Other researchers analyzing the NEISS data reached similar conclusions. Flaherty et al. (2020) assessed magnet ingestions for children 17 years of age and younger using NEISS data covering 2009 through 2019.³⁰ Three time periods including (1) 2009 through 2012, before CPSC adopted a mandatory standard for magnets in non-children’s toys; (2) 2013 through 2016, during the announcement and adoption of the CPSC mandatory standard for magnet sets; and (3) 2017 through 2019, after the CPSC rule was vacated. Following 2012 CPSC actions, ED visit rates decreased from an aggregate mean of 3.58 (95% CI, 2.20–4.96) per 100,000 persons to 2.83 (95% CI, 1.60–4.06) per 100,000 persons in 2013 through 2016 (slope change, 0.87 [95% CI, 0.71–1.03] ED visits per 100, 000 annually). From 2017 through 2019, the mean ED visit rate increased to 5.16 (95% CI, 3.22–7.11) per 100,000 persons, with an overall upward trend (slope change, –0.58 [95% CI, –0.68 to –0.47] per 100,000 persons annually).

Reeves et al. (2020) obtained similar findings on suspected magnet ingestion (SMI) cases involving children 17 years of age and younger using NEISS data.³¹ There were an estimated 23,756 (CI, 15,878–30,635) total SMI cases between 2009 and 2019. Of those, an estimated 3,709 (CI, 2,342–5,076) cases involved small/round magnets and 6,100 (CI, 3,889–8,311) involved multiple magnets. The average annual increase in total cases was 6.1 percent over this time period (P=0.01). There was also a statistically significant increase in small/round magnet ingestions (P<0.001) and multiple ingestions (P=0.02) between 2009 and 2019. When stratified by time period, there were 6,391 (CI, 4,181–8,601) estimated total magnet ingestion cases during the period in which CPSC announced and adopted the magnet sets rule (2013–2016), or 1,598

³⁰ Flaherty MR, Buchmiller T, Vangel M, Lee LK. Pediatric Magnet Ingestions After Federal Rule Changes, 2009-2019. *JAMA*. 2020;324(20):2102–2104. doi:10.1001/jama.2020.19153.

³¹ Reeves, Patrick & Rudolph, Bryan & Nylund, Cade. (2020). Magnet Ingestions in Children Presenting to Emergency Departments in the United States 2009-2019: A Problem in Flux. *Journal of pediatric gastroenterology and nutrition*. 71. 10.1097/MPG.0000000000002955.

(CI, 1,045–2,150) estimated cases per year. Conversely, there were 8,478 (CI, 5,472–11,485) estimated total cases during the period after the rule was vacated (2017–2019), or 2,826 (CI, 1,824–3,828) each year. This represents a 32 percent increase ($P < 0.001$) in total magnet ingestions after 2016. There was also a statistically significant increase in the number of estimated small/round ($P < 0.01$) and multiple ($P < 0.001$) magnet ingestions across these two time periods, with 164 (CI, 66–263) small/round and 350 (CI, 200–500) multiple magnet ingestions during the 2013 through 2016 period compared to 541 (CI, 261–822) small/round and 797 (CI, 442–1152) multiple magnet ingestion cases in the 2017 through 2019 period.

The increase in recent years, particularly since the 2014 rule on magnet sets was vacated, was also observed by researchers who analyzed national poison center data. Middelberg et al. (2021) examined magnet foreign body injuries in pediatric patients utilizing the National Poison Data System (NPDS).³² These researchers found that magnet exposure calls increased by 444 percent from 281 per year (2012–2017) to 1,249 per year (2018–2019). Considering incidents dating back to 2008 (5,738 total), the incidents from 2018 and 2019, alone, account for 39 percent of the magnet incidents since 2008. These researchers drew similar conclusions to CPSC staff, asserting that significant increases in magnet injuries correspond to time periods in which high-powered magnet sets were allowed to be sold.

Hazard Patterns

Tabs B and C discuss the hazard patterns observed in the data, particularly from the CPSRMS data, which included 284 magnet ingestion incidents. Of these 284 CPSRMS-reported ingestions, 214 ingestions involved products categorized by staff as identified or described as products for amusement or jewelry. Of the remaining incidents, 43 ingestions involved unidentified products and 27 ingestions involved products identified by staff as not subject to the draft proposed rule (“home/kitchen” products and “F963 magnet toys”). See Figure 2.

³² Middelberg LK, Funk AR, Hays HL, McKenzie LB, Rudolph B, Spiller HA, Magnet Injuries in Children: An Analysis of the National Poison Data System From 2008-2019, *The Journal of Pediatrics* (2021), doi: <https://doi.org/10.1016/j.jpeds.2021.01.052>.

Figure 2: Histogram by Incident Year and Magnet Category for CPSRMS-Reported Magnet Ingestions, January 2010—December 2020*

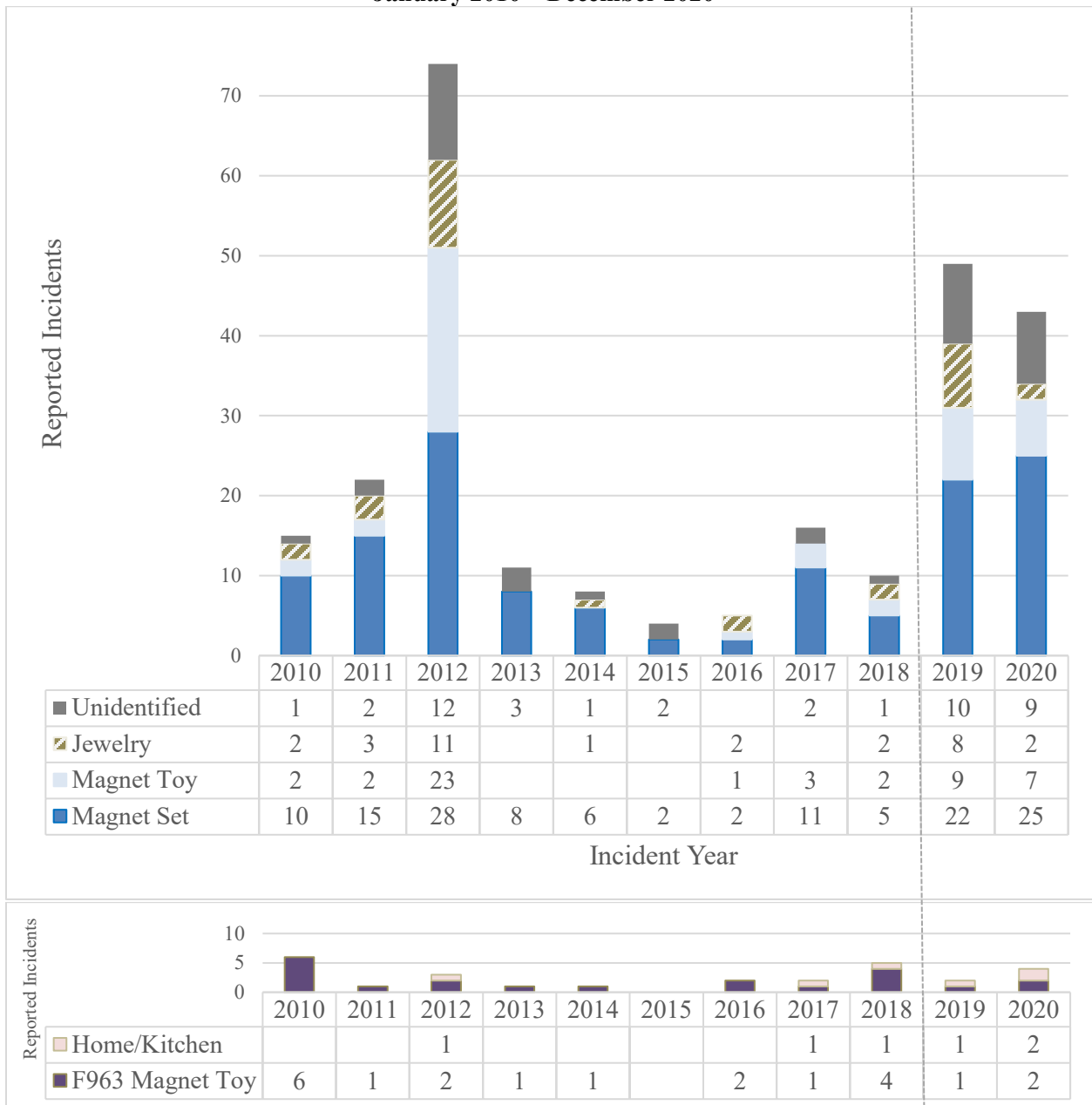

*CPSRMS reporting for the years 2019-2020 is ongoing, and counts for those years may increase as reporting continues.

Among other pertinent factors, staff considered in the NEISS and CPSRMS data: magnet product types, victims’ ages, victim and caregiver behavioral patterns, and sources of access to the magnets. Staff found that, where product type was specified, most incidents involved products identified or described as intended for play or jewelry. Of the identified products involved in

incidents, the most common were magnet sets intended for adult amusement (outside the scope of ASTM F963).

Excluding the incidents categorized by staff as out-of-scope (see below), victims' ages spanned 6 months to 54 years, with most victims aged 16 or under. Staff found that the involved age distribution has serious implications for measures to address the hazard, such as warnings and child resistant packaging; for example, the majority of the incidents involved victims over the age of 5, for whom child resistant packaging is designed to prevent access. Where interaction scenarios were specified, the most common uses of the magnet products at the time of ingestion were (1) victims playing with the magnets in their mouths (such as testing the attraction through their teeth), followed by (2) victims, particularly older children and teens, using magnets as bracelets, necklaces, and simulated piercings/studs. Staff found that victims typically acquired magnets loose and not with their packaging, making any on-package labeling immaterial. Reports for many incidents indicate clearly that products intended for adults, such as adult magnet sets, were purchased for children under 14. A common explanation for this was that the caregivers did not expect the children to swallow magnets.

Most reports did not mention if warnings or age labels were present; however, staff found that at least 45 incidents involved products with warnings about the hazard, and at least 49 incidents had warnings to keep the product away from children. Considering also incidents received by CPSC after January 8, 2021, Tab C specifically discusses reports for 17 incidents involving a magnet set with clear and repeated warnings about the hazard and to keep the product away from children, and which also has marketing only to adults.³³ At least 10 of these incidents resulted in surgery. These incidents demonstrate that warnings are not sufficient for preventing children from accessing hazardous magnets intended for adult amusement, nor preventing them from ingesting the magnets. Detailed below, even strong warnings are inadequate to prevent this hazard as they rely on persuading children, teens, and caregivers to avoid the hazard, as opposed to the draft proposed rule, which would limit the capability of such products from creating the hazard.

Regarding the out-of-scope products, staff did not find any incident reports related to products identified or described as products intended only for education and research except for perhaps one incident that described a magnet product as a "science kit." The report for this incident did not, however, provide product information beyond the use of the phrase "science kit," so the purposes and intended users of this product are uncertain. Similarly, only one incident involving a home/kitchen product, and six incidents involving known children's toys subject to ASTM F963, had evidence of internal interaction of magnets through tissue; and the children's toys were not compliant with the existing mandatory standard (including recalled products). Furthermore, only one incident demonstrated use of magnets from a home/kitchen product as jewelry at the time of the incident, and no incidents demonstrated use of magnets from known children's toys as jewelry at the time of the incident. This is important to consider because use of magnets as jewelry is one of the two most common use patterns reportedly involved in magnet

³³ Many of these 17 incidents occurred after the NEISS and CPSRMS data extraction, and are not captured in the datasets discussed in this memorandum. All of these incidents were recent, having occurred between 2018 and mid-2021. These incidents include reports received up to and including August 22, 2021.

ingestion incidents, and staff finds it unlikely that these excluded products will be used in this hazardous manner.

Overall, these data support staff's recommendation to exclude home/kitchen products from the draft proposed rule because incidents involving these products almost never had evidence of internal interaction through tissue, and are not reported to be used commonly in jewelry incidents. These data also support the effectiveness of the magnet requirements specified in the toy standard for addressing magnets in children's toys; that is, since the toy standard was mandated, children's toys have not commonly been involved in magnet ingestion incidents resulting in internal interaction injuries and, when they were involved in such injuries, they could have been addressed through the existing toy standard because they did not comply with that standard. Moreover, children's toys are not reported being used as jewelry in magnet ingestion incidents, so need not be addressed for that hazard pattern.

B. Assessment of Existing Standards for Hazardous Magnets

Tabs C and D detail staff's assessment of existing domestic standards pertaining to hazardous magnets in consumer products. These standards include one voluntary standard that has been adopted as a mandatory standard and three additional voluntary standards. Below, staff summarizes the relevant requirements in the standards and staff's assessment of the standards.

1. ASTM F963 – 17, *Standard Consumer Safety Specification for Toy Safety*, is a mandatory standard (16 CFR part 1250), which includes performance and safety messaging requirements for objects designed, manufactured, or marketed as a plaything for children under 14 years of age. This standard identifies magnets and magnetic components as hazardous if they fit entirely within the small parts cylinder specified in the standard and have a flux index of $50 \text{ kG}^2 \text{ mm}^2$ or higher. The standard requires that children's toys shall not have an as-received hazardous magnet or hazardous magnetic component, nor liberate a hazardous magnet or hazardous magnetic component, per specified testing, with the exception of "magnetic/electrical experimental sets"³⁴ intended for children 8 years of age and over, which may instead use specified warning labeling.
2. ASTM F2923 – 20, *Standard Specification for Consumer Product Safety for Children's Jewelry*, is a voluntary standard, which includes performance and safety messaging requirements for jewelry designed or intended primarily for children 12 years of age or younger. This standard refers to ASTM F963 for the identification of magnets and magnetic components as hazardous.³⁵ This standard requires that children's jewelry shall not have an as-received hazardous magnet or hazardous magnetic component, nor liberate a hazardous magnet or hazardous magnetic component, per testing specified in ASTM F963, with the exemption of children's jewelry intended for children 8 years of

³⁴ ASTM F963 currently exempts from magnet performance requirements products identified in the standard as "magnetic/electrical experimental sets" for ages 8 years and older. These toys are sometimes referred to as "science kits," and they contain one or more magnets intended for carrying out educational experiments involving both magnetism and electricity. Per section A12.4 of ASTM F963 – 17, the intended scope of products subject to this labeling exemption are only those that combine magnetism and electricity, such as electrical motors and doorbells.

³⁵ However, the standard specifies that "hazardous magnetic component" does not include chains with a length greater than 6 inches.

age or older consisting of earrings, brooches, necklaces, or bracelets. These products with hazardous magnets, as well as their instructions, if any, are required to include specified warnings.

3. ASTM F2999 – 19, *Standard Consumer Safety Specification for Adult Jewelry*, is a voluntary standard, which includes safety messaging recommendations for jewelry designed or intended primarily for use by consumers over age 12. This standard identifies a magnet as hazardous if it has a flux index *greater than 50* as measured by the method described in ASTM F963. This standard recommends that adult jewelry containing hazardous magnets as received *should* include a specified warning.
4. ASTM F3458 – 21, *Standard Specification for Marketing, Packaging, and Labeling Adult Magnet Sets Containing Small, Loose, Powerful Magnets (with a Flux Index $\geq 50 \text{ kG}^2 \text{ mm}^2$)*, is a voluntary standard, which includes marketing, packaging, labeling, and warning requirements for adult magnet sets with hazardous magnets, which the standard describes as intended for persons 14 years of age and older. The standard identifies hazardous magnets consistent with ASTM F963.

Based on the existing data, staff supports the performance requirements for hazardous magnets specified in ASTM F963, and referenced in the other standards, for the full scope of products included in the draft proposed rule. Staff acknowledges that there is some lack of certainty about a potentially lower flux index bound for ingested magnets to present the internal interaction hazard. However, staff is not aware of conclusive evidence of magnets under $50 \text{ kG}^2 \text{ mm}^2$ presenting this hazard. Detailed in Tab D, staff has tested numerous samples of a specific magnet set involved in internal interaction injuries, which had magnets above and below $50 \text{ kG}^2 \text{ mm}^2$, and it is unknown if the specific magnets involved in the injuries would have resulted in internal interaction injuries absent the involvement of the magnets $50 \text{ kG}^2 \text{ mm}^2$ or greater. Consistent with ASTM F963, the draft proposed rule requires that every loose or separable magnet in the set must be less than $50 \text{ kG}^2 \text{ mm}^2$ if it fits entirely within the small parts cylinder, meaning this product would not be compliant. In addition, by establishing a limit of less than $50 \text{ kG}^2 \text{ mm}^2$, staff recognizes that in order for manufacturers to account for manufacturing variance/tolerance, firms complying with the rule are likely to produce magnets below this limit. Staff notes too that the identification and prohibition of hazardous magnets per ASTM F963, including the exemption for magnetic/electrical experimental sets, was determined by consensus, supported in other international standards, including the European standard, EN 71-1:2014, *Safety of Toys; Part 1: Mechanical and Physical Properties*, and ISO 8124-1:2018, *Safety of Toys — Part 1: Safety Aspects Related to Mechanical and Physical Properties*, and implemented by regulators in other countries, as discussed above.

Due to the lack of product-identifying information in the majority of the incident reports, staff is unable to comment with certainty regarding compliance with these standards; however, staff has found that relatively few of the known products involved in internal interaction incidents (2010 through 2020) were toys subject to ASTM F963, which likely supports its effectiveness for children's toys. Furthermore, as discussed above, CPSC's recalls of children's toys due to hazardous magnets peaked shortly after the standard was mandated, and have since fallen substantially. ASTM F963 has a limited scope as it excludes the subject magnet products, such as children's jewelry and products intended for amusement of users 14 years and older. Incident

data indicate that these products are commonly involved in magnet ingestion incidents, and that children ingest magnets from products for which they are younger than the intended user age; therefore, staff finds ASTM F963's scope is inadequate to address the hazard. Staff finds the other standards inadequate as well, as they, too, are limited in product scope, and additionally they depend too heavily on safety messaging and packaging requirements, which as discussed below and in Tab C, are ineffective methods by which to address the hazard.

C. Alternative Options to Reduce Risk

Staff considered various alternative options to reduce the risk of the internal interaction hazard, including safety messaging and special packaging, aversive agents to deter ingestion, future ASTM activities, and performance requirements. Tab F discusses the potential costs and benefits associated with alternatives.

Safety Messaging

Strong warnings and marketing pertaining to the hazard and use for adults only may be able to inform and convince some consumers to keep the subject magnet products away from children and teens. However, staff does not find this to be an effective approach to address the hazard. Attempting to protect consumers by warning them about the hazard is inherently inadequate and less effective than designing out the hazard or designing guards against the hazard. This is because safety messaging depends solely on persuading consumers to avoid hazards, and numerous factors, as discussed in Tab C, can impede the likelihood of the safety messaging being read and followed consistently, particularly for the subject magnet products. There have been numerous public outreach efforts by medical associations and other consumer advocacy groups to warn consumers about the internal interaction hazard posed by hazardous magnets used for amusement and jewelry. These groups include the American Academy of Pediatrics (AAP),³⁶ the North American Society for Pediatric Gastroenterology, Hepatology and Nutrition (NASPGHAN),³⁷ Consumer Reports,³⁸ Consumer Federation of America,³⁹ Kids in Danger,⁴⁰ and many others. There have also been articles on the internal interaction hazard from general news sources, including the Washington Post.⁴¹ Even after years of safety messaging efforts from a large variety of sources, magnet ingestion incidents involving the subject magnet products continue to grow in number. Staff's chief concern is that the internal interaction hazard is a hidden hazard, and children, teens, and caregivers are unlikely to anticipate and appreciate the likelihood and severity of the hazard, and the often-accidental nature of the hazard, particularly

³⁶ Magnets safety information on AAP website: <https://services.aap.org/en/search/?k=magnets>.

³⁷ Magnets safety information on NASPGHAN website: <https://www.naspghan.org/content/72/en/Foreign-Body-Ingestion>.

³⁸ Example of 2017 Consumer Reports magnet hazard awareness-raising material on the Consumer Reports website: <https://www.consumerreports.org/product-safety/magnets-marketed-as-toys-could-be-dangerous-to-kids/>.

³⁹ Example of 2012 public outreach article from Consumer Federation of America: <https://consumerfed.org/testimonial/cfa-comments-cpsc-notice-proposed-rulemaking-safety-standard-magnet-sets/>.

⁴⁰ Example of 2011 public outreach article from Kids In Danger: <https://kidsindanger.org/2011/11/cpsc-warns-about-high-powered-magnets/>.

⁴¹ For example, see The Washington Post article on surging magnet ingestion incidents, by Todd Frankel: https://www.washingtonpost.com/business/economy/number-of-children-swallowing-dangerous-magnets-surges-as-industry-largely-polices-itself/2019/12/25/77327812-2295-11ea-86f3-3b5019d451db_story.html.

as it predominantly involves children whom they would not expect to ingest inedible objects, such as magnets. Discussed above, and detailed in Tab C, incident reports demonstrate failures of strong and repeated warnings to deter products, including magnet sets intended for ages 14 years and older, from being given to and used by children. For example, the in-depth investigation report for an incident from April 2020 indicates that the father of an 11-year-old victim believed the adult magnet set was age appropriate for the victim because he did not expect the victim to place magnets inside the victim's mouth while playing, nor ingest the magnets. Furthermore, many incidents indicate magnets were acquired by children without the packaging, such as when shared between children and when found loose in their environment, making on-package warnings immaterial in these incidents.

Special Packaging

In theory, special packaging for the subject magnet products can be used to help consumers control access to the products, and may act as reminders for consumers that the products contain hazardous magnets. As part of the ASTM F15.77 subcommittee, as well as staff's 2020 informational briefing package regarding magnet sets,¹² staff considered child resistant features and methods for identifying visually if all of the magnets have been collected in the package. Discussed in Tab C, staff finds that such features may help prevent some children and teens from accessing hazardous magnets; however, ultimately, staff does not find, for a number of reasons, special packaging to be an adequate method to address this hazard. For example, child resistant features, such as those consistent with the Poison Prevention Packaging Act (PPPA),⁴² would need to be used correctly and consistently, which staff finds unlikely for these products intended for amusement and jewelry; even then, such packaging may only prevent access to children under 5 years of age, ages that represent only a minority of the victims in the incident data. As stated above, many incidents involved children acquiring magnets without packaging, such as from friends and classmates, and therefore, special packaging features are immaterial in these incidents. Another concern is that the small size, and in some cases large quantity, of the magnets in the subject magnet products can make locating and counting the magnets after every use infeasible, and increase the costs of compliance, such as time and effort, beyond the actions consumers can and are willing to take. For example, some manufacturers of magnet sets recommend creating a structure, such as a 6 by 6 by 6 cube (216 magnets), to verify that all of the magnets are present, but the child and caregiver may not have the time, capability, or willingness to do this after every use. The subject magnet products include building sets and fidget toys, and consumers may prefer not to disassemble creations after each assembly, nor repackage all of the magnets after each use. For example, an in-depth investigation report for one incident from May 2020 indicates that the 6-year-old victim and her 12-year-old sister typically left their magnet set magnets out of their packaging, distributed on furniture pieces in various locations around the house.

Aversive Agents

Warnings may be employed that use sensory modalities other than vision to make loose or separable hazardous magnets less appealing for children and teens to put in their mouths.

⁴² 16 CFR parts 1700, 1701, 1702. For more information, see the CPSC webpage on "Poison Prevention Packaging Act": <https://www.cpsc.gov/Regulations-Laws--Standards/Statutes/Poison-Prevention-Packaging-Act/>.

Discussed in Tab C and staff's 2014 package on magnet sets,⁹ aversive agents, such as foul odors or bitterants, may dissuade some children and teens from placing hazardous magnets into their mouths; however, ultimately, such features would not be effective universally, and CPSC has found that aversive agents do not adequately deter or prevent ingestions. Although the use of aversive agents might discourage some children from placing additional magnets in their mouths, incident reports indicate that serious injury is possible when one ingests as few as two magnets, or one magnet and a ferromagnetic object, and children might ingest multiple magnets before they detect the aversive agent. Children frequently ingest unpalatable substances, such as gasoline, cleaners, and ammonia, indicating that unpleasant taste or odor, alone, is not sufficient to deter children from ingesting items or substances. In addition, some portion of the population, possibly as high as 30 percent, may be insensitive to certain bitterants.

Future ASTM Activities

Detailed in Tab C, staff is continuing to work with the ASTM F15.77 subcommittee on magnets. There appears to be interest in the subcommittee to develop performance requirements for adult magnet sets, such as limitations in size and strength based on the requirements in ASTM F963. Such requirements would address the internal interaction hazard for magnet sets; however, there are considerable risks for delaying staff's draft proposed rule to await these potential revisions, including the following: (1) it is unknown if and when the standard will incorporate adequate performance requirements, (2) compliance with the standard, and any revised standard, is unknown, and (3) the product scope is limited to magnet sets, and may be further limited for performance requirements (such as specific shapes of magnets), and therefore may not adequately address the hazard (while magnet sets are a particular concern, the majority of incidents involve uncertain magnet products).

Additional Alternatives

Tab F discusses several additional alternatives to the draft proposed rule, and the limitations of those alternatives. They include proposing less stringent performance requirements, and applying a longer effective date to the final rule. Tab F also discusses the potential costs and benefits associated with the alternatives.

D. Recommendations

Staff recommends addressing the magnet internal interaction hazard through performance requirements, which limit the capability of ingested magnets to interact internally or limit their ingestion. These performance requirements, which align with the identification and testing of hazardous magnets specified in ASTM F963 – 17 (16 CFR part 1250), would apply to consumer products that are intended for purposes such as amusement and jewelry; purposes that make the products more likely to be accessed by children and used in hazardous manners, such as playing with the magnets in their mouths and using the magnets to simulate oral piercings. The sections that follow explain staff's recommended product scope and performance requirements.

Recommended Scope

Staff recommends that the subject magnet products include products with one or more magnets, which are loose or separable, and designed, marketed, or intended to be used by consumers for entertainment, jewelry (including children's jewelry), mental stimulation, stress relief, or a combination of these purposes. Although the majority of the magnet ingestion incidents lack certainty in product identification, staff concludes, based on the reasons summarized below and detailed in this package, that it is likely that a substantial proportion of these incidents involved magnets from the subject magnet products.

- *Product types and use patterns in incident data:* Staff has found that, where product type was identified or described, incidents typically involved products for purposes of amusement or jewelry, such as magnetic desk toys and magnetic faux piercings/studs. Similarly, where an interaction scenario was reported, incidents overwhelmingly indicated the magnets were played with or used to simulate mouth piercings, at the time of the ingestions. As explained in Tab C, these findings are not surprising, as staff considers it foreseeable that children are more likely to gain access to magnets from products intended for these non-threatening amusement and jewelry purposes, and use the magnets in these common, hazardous manners (for play in and around the mouth and simulating lip, tongue, and cheek piercings). Incidents grouped as “unidentified” had insufficient information to identify the magnet product category although product characteristics and use patterns often shared commonalities with subject magnet products. Reports for these unidentified products typically describe the involved magnets as small balls, which is the most common shape used for magnet sets. Considering the trends in ingestions relative to the 2014 rule and the effectiveness of ASTM F963, among other factors, staff finds it reasonable to conclude that the incidents grouped as “unidentified” most likely involved magnets from the subject magnet products. Magnet sets are a particularly concerning, significant subset of the subject magnet products. Magnet sets are one of the most common products identified in NEISS reports, and the most common product identified in CPSRMS reports. These products typically contain hundreds to even thousands of loose, hazardous magnets, and incidents involving these products demonstrate that children and teens continue to access and ingest these magnets despite strong safety messaging aimed at persuading them and their caregivers to avoid the hazard.
- *Magnet ingestion incidents relative to the 2014 rule on magnet sets:* Staff and other researchers found a strong relationship between the 2014 rule on magnet sets and the numbers of magnet ingestions (NEISS and CPSRMS) and magnet exposure calls (NPDS). The data show that magnet-related incidents dropped substantially while the rule was in place, and rose substantially after it was vacated. Staff and other researchers conclude that this strong relationship is likely indicative of the success of the 2014 rule in reducing the number of magnet-related incidents while the rule was in place. This decline and subsequent increase in magnet ingestions surrounding the magnet sets rule also indicates that the resurgence of incidents after the rule was vacated likely involved magnet sets, since they were the products subject to the rule.

- *Alignment with consumer advocacy groups and foreign regulators:* Numerous consumer advocacy groups, including medical associations, have struggled to convey to the public the serious risks of harm posed by hazardous magnets in products used for amusement and jewelry, particularly magnet sets. In addition, foreign regulators have adopted prohibitions for magnet sets and hazardous magnets in other products in order to address this hazard. Staff agrees with these groups that the dangers of having loose or separable hazardous magnets in the subject magnet products outweigh the utility they add to amusement and jewelry. As discussed in Tab E, staff is aware of magnet sets compliant with the draft proposed rule, which are marketed for the same purposes as their noncompliant counterparts. Additionally, there are other products, such as magnetic desk sculptures (large magnetic base with ferromagnetic pieces), which fulfill similar purposes and do not present the magnet internal interaction hazard.

Staff excluded from the scope of the draft proposed rule home and kitchen products, such as shower curtains and hardware (magnets for fastening items together), and products intended only for education and research, such as science kits used at schools or universities because these products do not meet the above criteria for the subject magnet products. While these product types may also present risk of the internal interaction hazard, children and teens are less likely to acquire and use them for amusement and jewelry because these products have a functional utility and a different purpose than amusement/jewelry. Staff did not find any incident reports that identified or described products intended only for education and research except for perhaps one incident that described a magnet product as a “science kit;” this incident did not have information about intended use or user of the product, and therefore it may have involved a subject magnet product. While staff did find incident reports involving home/kitchen products, only reports for two incidents indicated that surgery was required as a result of the magnet ingestion, and only one incident had evidence of internal interaction through tissue. Furthermore, staff observed only one incident reporting the use of magnets from home/kitchen products as jewelry.

Children’s toys subject to ASTM F963 are also excluded from the scope of the draft proposed rule, as these products are already subject to requirements for magnet size and strength that are consistent with the draft proposed rule. Since the toy standard was mandated, children’s magnet toys have rarely been involved in incidents resulting in internal interaction injuries, and recalls involving children’s toys have diminished, as well. Therefore, staff concludes that most children’s toys on the market are compliant with ASTM F963 and that the incident reports discussed above are likely due to subject magnet products including amusement/jewelry and unidentified product categories, not children’s toys.

Recommended Performance Requirements

Staff recommends using for the subject magnet products the magnet size and strength requirements established by ASTM F963 to effectively reduce the likelihood of children and teens ingesting hazardous magnets. Under the draft proposed rule, any loose or separable magnets in the subject magnet products must meet the following criteria: (1) each magnet must be too large to fit entirely within the small parts cylinder described in 16 CFR 1501.4; or (2) each magnet must have a flux index of less than $50 \text{ kG}^2 \text{ mm}^2$, as measured by the procedures for determining the magnetic attractive force described in ASTM F963.

Detailed in Tab D, staff finds these size and strength limitations are the most widely-accepted methods to address hazardous magnets. They were developed by consensus of experts in the field; they are enforced domestically for children's toys (16 CFR 1250); and they are incorporated in international standards and foreign regulations. Staff concludes that these size and strength limitations have been effective for addressing hazardous magnets in children's toys. Discussed above, children's toys were rarely identified in incident reports describing internal interaction dating back to 2010, and the incidents of internal interaction involved products not compliant with the toy standard (such as recalled magnetic tile sets). In the years immediately following the prohibition of hazardous magnets in ASTM F963 (2006 to 2009), there were a large number of recalls of children's toys with hazardous magnets.⁴³ The number of children's toy recalls has since diminished substantially, and staff attributes this decline to the effectiveness of ASTM F963.

As discussed above, similar limitations were incorporated in the 2014 rule on magnet sets (79 FR 59962), and staff and other researchers conclude the substantial decrease in magnet-related incidents (exhibited in NEISS, CPSRMS, and NPDS) around the 2014 rule, and the substantial increase in incidents after the rule was vacated, are likely indicative of the success of the 2014 rule in reducing appreciably the number of magnet-related incidents while it was active.

The most common magnets staff identified in incident reports are 3 to 6 mm (typically 5 mm) in diameter and have flux indexes of 300 to 400 kG² mm². Therefore, limiting the flux index to less than 50 kG² mm² would address many of these products, and manufacturers complying with the rule are likely to produce magnets below this limit to account for manufacturing variability. Staff acknowledges that there is inconclusive evidence of smaller magnets with flux indexes below 50 kG² mm² potentially presenting the internal interaction hazard and resulting in injuries, and recommends soliciting comments from the public on this matter (section F, below).

Certification and Notice of Requirements

The CPSA defines a "children's product" as "a consumer product designed or intended primarily for children 12 years of age or younger" and states that, when determining whether a product is primarily intended for children 12 years and younger, to consider the following factors:

- (1) manufacturer statements about the intended use of the product, including a label on the product if such statement is reasonable;
- (2) whether the product is represented in its packaging, display, promotion, or advertising as appropriate for use by children 12 years of age or younger;
- (3) whether the product is commonly recognized by consumers as being intended for use by a child 12 years of age or younger; and
- (4) the Age Determination Guidelines issued by CPSC staff in September 2002, and any

⁴³ Examples of children's magnet toy recalls include the following: (1) <https://www.cpsc.gov/Recalls/2006/childs-death-prompts-replacement-program-of-magnetic-building-sets>, (2) <https://www.cpsc.gov/Recalls/2007/magnetix-magnetic-building-set-recall-expanded-serious-injuries-continue-to-be-reported>, (3) <https://www.cpsc.gov/Recalls/2006/serious-injuries-prompt-recall-of-mattels-polly-pocket-magnetic-play-sets>, and (4) <https://www.cpsc.gov/Recalls/2007/additional-reports-of-magnets-detaching-from-polly-pocket-play-sets-prompts-expanded>.

successor to such guidelines.⁴⁴

Some subject magnet products are marketed, packaged, displayed, promoted, and/or advertised as intended for children 12 years old and younger and, therefore, are “children’s products.” For example, children’s jewelry is a subject magnet product and is intended for users 12 years and younger. However, most subject magnet products are not children’s products.

Section 14(a) of the CPSA includes requirements for certifying that children’s products and nonchildren’s products comply with applicable mandatory standards. Section 14(a)(1) addresses required certifications for non-children’s products, and sections 14(a)(2) and (a)(3) address certification requirements specific to “children’s products.”

The Commission interpreted these statutory provisions in its regulation 16 CFR part 1200, which provides further detail. This regulation includes specific examples involving jewelry in § 1200.2(d)(3). Although some subject magnet products, including jewelry, meet the definition of a “children’s product,” many do not. If the Commission issues a final rule for the subject magnet products, manufacturers or importers of subject magnet products that are non-children’s products must test products to the rule and issue a General Certificate of Conformity (GCC) demonstrating compliance, and manufacturers of subject magnet products that are children’s products must have products third-party tested by a CPSC-accepted laboratory, and issue a Children’s Product Certificate (CPC) demonstrating compliance with the rule. The Commission’s regulation on requirements for certificates of compliance is codified in 16 CFR part 1110.

Section 14(a)(1) of the CPSA requires every manufacturer of a non-children’s product, which includes the importer, that is subject to a consumer product safety rule under the CPSA or a similar rule, ban, standard, or regulation under any other law enforced by the Commission and which is imported for consumption or warehousing or distributed in commerce, to issue a certificate. The manufacturer must certify, based on a test of each product or upon a reasonable testing program, that the product complies with all rules, bans, standards, or regulations applicable to the product under the CPSA or any other law enforced by the Commission. The certificate must specify each such rule, ban, standard, or regulation that applies to the product.

For children’s products, section 14(a)(2) of the CPSA states that, before importing for consumption or warehousing or distributing in commerce any children’s product that is subject to a children’s product safety rule, the manufacturer (including the importer) must submit sufficient samples of the children’s product, or samples that are identical in all material respects to the product, to a CPSC-recognized third party conformity assessment body accredited under section 14(a)(3) of the CPSA (“recognized third party test laboratory”). The recognized third-party test laboratory must test the children’s product for compliance with such children’s product safety rule. Based on the testing, the manufacturer (or private labeler) must issue a certificate that certifies that the children’s product complies with the children’s product safety rule based on the assessment of a recognized third-party laboratory accredited to conduct such tests. The Commission’s requirements for testing and labeling children’s products is codified in 16 CFR part 1107. Additionally, part 1109 sets forth requirements for using the testing of component

⁴⁴ Current 2020 Guidelines can be accessed via https://www.cpsc.gov/s3fs-public/pdfs/blk_media_adg.pdf.

parts to meet the testing and certification requirements for both children's and non-children's products.

Section 14(a)(3)(A) of the CPSA states that the third-party testing requirement applies to any children's product manufactured more than 90 days after the Commission has established and published a "notice of requirements" (NOR) for the accreditation of third-party conformity assessment bodies to assess conformity with a children's product safety rule. The Commission published a final rule regarding Requirements Pertaining to Third Party Conformity Assessment Bodies, codified in 16 CFR part 1112. 78 Fed. Reg. 15836 (Mar. 12, 2013). Part 1112 establishes the requirements for accreditation and acceptance of third-party testing laboratories to test for compliance with a children's product safety rule. The final rule also codifies a list of all of the NORs that CPSC has published, to date, for children's product safety rules. All new children's product safety rules require an amendment to part 1112 to be added to the list of NORs.

For subject magnet products that are children's products, staff recommends that the Commission propose to amend part 1112 to include subject magnet products that are children's products in the list of children's product safety rules for which CPSC has issued NORs. Commission approval of accreditation requirements for the testing of subject magnet products that are children's products will make effective the third-party testing and certification requirement for subject magnet products that are children's products manufactured more than 90 days after the Commission has established and published an NOR for the accreditation of third-party conformity assessment bodies to assess conformity with the children's product safety rule for subject magnet products.

Effective Date

The draft proposed rule includes an effective date of 180 days after the final rule is published in the Federal Register. That would give manufacturers approximately 6 months to understand the requirements, and modify, replace, or discontinue noncompliant subject magnet products. Staff is aware of magnet products that comply with the draft proposed standard and, therefore, considers this a reasonable effective date because many products would not require modification to comply with the draft proposed rule and because already compliant products demonstrate the feasibility and existence of compliant technology.

E. Economic Assessment of Draft Proposed Rule

Tab E contains the preliminary regulatory analysis, and Tab F contains the Initial Regulatory Flexibility Analysis, which discusses the potential impact of the draft proposed rule on small entities.

The preliminary regulatory analysis (Tab E), which discusses the benefits and costs of the draft proposed rule, is conducted from a societal perspective, considering all of the significant costs and health outcomes. Benefits and costs are preliminarily calculated on a per-product in-use basis, an approach that has been found useful at the CPSC. The expected benefits of the draft proposed rule would be the reduction in the societal costs that would have been associated with

those products. The costs would consist of the lost utility to consumers because they would no longer be able to purchase and use the magnets (lost consumer surplus), and the lost income of producers who would no longer be able to produce and sell the subject magnets (lost producer surplus).

Estimated Benefits of the Draft Proposed Rule

The expected benefits of the rule are a reduction in the risk of death and serious injury to children and teens due to ingestion of magnets from the subject magnet products. The Directorate for Economic Analysis (EC) considered estimates of the injuries and the societal costs associated with ingestions that involved the subject magnet products based on NEISS cases categorized by staff as “magnet sets,” “magnet toy,” or “jewelry.” Staff combined these groupings under the name “Amusement/Jewelry.” EC used the CPSC’s Injury Cost Model (ICM) to estimate the societal costs of injuries initially treated in hospital EDs, as well as in other medical settings, such as, physicians’ offices, clinics, and ambulatory surgery centers. Societal costs associated with magnet ingestion injuries include the following considerations, among others:

- Medical costs: (1) medical and hospital costs associated with treating the injury victim during the initial recovery period and in the long run, including the costs associated with corrective surgery, the treatment of chronic injuries, and rehabilitation services; (2) ancillary costs, such as costs for prescriptions, medical equipment, and ambulance transport; and (3) costs of health insurance claims processing.
- Work loss estimates: (1) the forgone earnings of the victim, including lost wage work and household work, (2) the forgone earnings of parents and visitors, including lost wage work and household work, (3) imputed long term work losses of the victim that would be associated with permanent impairment, and (4) employer productivity losses, such as the costs incurred when employers spend time juggling schedules or training replacement workers.
- Intangible, or non-economic, costs of injury: the physical and emotional trauma of injury as well as the mental anguish of victims and caregivers.

Based on the NEISS data for 2017 through 2020 (years following revocation of the previous mandatory rule), the ICM projects there may have been an estimated total of about 3,255 medically-treated injuries annually involving the subject magnet products from 2017 through 2020. Based on ICM estimates, these injuries resulted in annual societal costs of about \$47.6 million (in 2018 dollars) during the 2017 through 2020 time period, excluding cases involving unidentified magnet products. Based on ICM estimates for unidentified magnet products involved in ingestion injuries, average annual societal costs for 2017 through 2020 totaled \$151.8 million. Consequently, to the extent that the unidentified magnet products were products that would be covered by the draft proposed rule, the Table 1 results could substantially understate the societal costs associated with the magnet products subject to the draft rule.

The annual expected benefits of the rule depend upon the exposure to risk associated with the subject magnet products, as well as the estimated societal costs described above. Although most of the subject magnet products retain much of their magnetism for many years, it is likely that many are discarded well before that time. The actual expected product life of the subject magnet

products is uncertain; therefore, EC presents in Tab E a range of potential benefit estimates under an assumed product life of one-and-one-half, two, and three years. Annual sales of subject magnet products are based on producer-reported annual magnet set sales collected by the Office of Compliance and Field Operations up through mid-2012, and assumptions of annual sales of all subject magnet products through 2020. EC used the CPSC's Product Population Model to project the average number of products in use and societal costs per unit.

Because the rule would limit sales to compliant products, the first order estimate of benefits would be equal to the present value of societal costs per unit, preliminarily estimated to range from about \$154 (with a 1.5-year product life and a 7 percent discount rate) to \$190 (with a 3-year product life and a 3 percent discount rate).

Estimated Costs of the Draft Proposed Rule

Both consumers and producers benefit from the production and sale of consumer products. The consuming public obtains the use value or utility associated with the consumption of products; producers obtain income and profits from the production and sale of products. Consequently, the costs of a rule would predominantly consist of the following: (1) the lost use value experienced by consumers who would no longer be able to purchase magnets that do not meet the standard at any price; and (2) the lost income and profits to firms that could not produce and sell non-complying products in the future. Both consumer and producer surplus depend upon, among other things, product sales. However, unit sales of subject magnet products are unknown. Therefore, EC preliminarily considers possible costs associated with a wide range of annual sales of subject magnet products.

Lost Utility to Consumers. Magnet sets, which likely comprise the vast majority of subject magnet products on the market and involved in magnet ingestion incidents, have been cited as having usefulness as a manipulative or construction item for entertainment, such as puzzle working, sculpture building, mental stimulation, or stress relief. Discussed in Tab C, staff also notes that use of magnets from magnet sets as jewelry is a common hazard pattern. The individual magnets might also have utility uses for other purposes, such as "refrigerator magnets." This information demonstrates that consumers derive utility from magnet sets and other subject magnet products from a wide variety of uses, even those not promoted by sellers.

Conceptually, consumers' use value includes the amount of consumer expenditures for the product, plus what is called "consumer surplus." Consumer expenditures represent the minimum value that consumers would expect to get from these products. Consumer surplus will vary for individual consumers, but it represents a benefit to consumers over and above what they had to pay. The consumer surplus would be, at most, the prospective *loss* in use value associated with the draft proposed rule. This is because consumers would no longer be able to obtain utility from the non-compliant products, but they would, nevertheless, still have the value of consumer expenditures for the products, money which could be used to buy other products providing use-value.

EC has no information regarding aggregate consumer surplus; and hence, the amount of utility that would be lost as a result of the draft proposed rule. However, if, for example, consumers who purchased the non-complying subject magnet products at an average price of \$20 would

have been willing to spend, on average, \$35 to \$45 per product (*i.e.*, an additional \$15 to \$25 per set), the lost utility might amount to about \$7.5 million (*i.e.*, [$\$35-\20] \times 500,000 units annually) to \$12.5 million (*i.e.*, [$\$45-\20] \times 500,000 units annually) on an annual basis. This calculation represents the maximum loss of consumer utility from the draft proposed rule, because consumers are likely to gain some amount of consumer surplus from products that are purchased as an alternative to those subject magnet products that would no longer be available because of the rule. If, for example, there were close substitutes (*e.g.*, products that are almost as satisfying and similarly priced) for the subject magnet products, that do meet the standard, the overall loss in consumer surplus (and, hence, the costs of the draft proposed rule) would tend to be small. On the other hand, if there are no close substitutes, the costs of the rule would tend to be higher. EC discusses known and potential substitutes for hazardous magnet products in more detail in Tab E.

Lost Benefits to Producers. The lost benefits to firms resulting from a rule are measured by a loss in what is called *producer surplus*. Producer surplus is a profit measure that is somewhat analogous to consumer surplus. Whereas consumer surplus is a measure of benefits received by individuals who consume products, net of the cost of purchasing the products, producer surplus is a measure of the benefits accruing to firms that produce and sell products, net of the costs of producing them. More formally, producer surplus is the total revenue (TR) of firms selling the magnets, less the total variable costs (TVC) of production. Variable costs are costs that vary with the level of output and usually include expenditures for raw materials, wages, distribution of the product, and the like. Apart from the import costs of the magnets, the variable costs of production are probably relatively small. Based on average revenue of \$20 per unit, EC preliminarily estimates that producer surplus would amount to about \$2.5 million to \$5 million annually for annual sales of 500,000 units, depending on the level of variable costs above the costs of importing the magnets. Staff notes that while this information is specifically related to magnet sets, a similar relationship could apply to other subject magnet products affected by the draft standard.

Actual sales levels of non-complying subject magnet products are unknown. Additionally, EC has no hard estimates of either consumer surplus or producer surplus. EC made rough preliminary estimates of the possible costs of the rule, for various hypothetical sales levels ranging from 250,000 to 1 million products annually. Based on this wide range of sales, the costs of the draft proposed rule, in the form of lost consumer surplus plus lost producer surplus, could range from \$5 to \$8.75 million (if sales amount to about 250,000 products annually), to about \$20 to \$35 million (if sales amount to about 1 million products annually).

Manufacturers/importers of subject magnet products would likely incur some additional costs to certify that their products meet the requirements of the draft proposed rule as required by Section 14 of the CPSA. The certification must be based on a test of each product or a reasonable testing program. The costs of the testing might be minimal, especially for small manufacturers that currently have product testing done for products subject to the requirements in ASTM F963, *Standard Consumer Safety Specification for Toy Safety*, which is mandated by 16 CFR part 1250. Importers may also rely upon testing completed by other parties, such as their foreign suppliers, if those tests provide sufficient information for the manufacturers or importers to certify that the magnets in their products comply with the draft proposed rule. As noted above, for subject magnet products that could be considered to be children's products, such

as children's jewelry, the certification must be based on testing by an accredited third-party conformity assessment body, at somewhat higher costs.

Summary of Preliminary Regulatory Analysis Results

Preliminarily estimated aggregate annual societal costs from ingestion injuries involving subject magnet products for 2017 through 2020 totaled \$47.6 million (excluding ingestion injuries involving unidentified magnet products). Assumptions about annual product sales and expected product life of one-and-one-half, two, and three years yields estimated numbers of products in use during those years ranging from 444,000 to 701,000. The estimated present value of societal injury costs per subject magnet product (at a 3% discount rate) ranges from \$160 per unit (at a 1.5-year expected life) to \$190 per unit (at a 3-year expected life). On the cost side, estimates of consumer and producer surplus were uncertain, but might range from about \$5-\$8.75 million to about \$20-\$35 million, based on unit sales ranging from 250,000 to 1 million. For illustrative purposes, considering annual unit sales of non-complying subject magnet products of 500,000, expected aggregate benefits could total \$80 to \$95 million annually; costs (lost consumer and producer surplus) could range from \$10 million to \$17.5 million annually. Thus, although both the benefits and costs of the draft proposed rule are uncertain, based on a range of assumptions, EC's estimates suggest that the benefits of the draft proposed rule may easily exceed the costs. Furthermore, these estimates exclude cases involving unidentified magnet products; therefore, to the extent that the unidentified magnet products were products that would be covered by the draft proposed rule, the benefits may be substantially greater due to understating the societal costs associated with the products subject to the draft proposed rule.

F. Comments to Solicit

There are additional considerations for staff's recommended product scope, flux index methodology, and flux index limit, for which input from the public is sought. These considerations for public comment include the following:

- Whether there is a more appropriate methodology, flux index limit, or both, for identifying magnets as hazardous. Staff is interested particularly in flux density measurement of 2 to 3 mm diameter spherical magnets, including difficulties in identifying pole surfaces. Staff finds it important to consider statistical sampling or similar methods by which to address products with multiple magnets, given variances identified by staff between like-magnets from the same magnet product/set. Similarly, staff recommends seeking comment on whether the rule should, instead, specify that a "representative sample" or at least one "representative sample" of each shape and size in a subject magnet product be tested, and how firms may satisfy such a requirement.
- Whether alternative performance requirements are appropriate, such as pertaining to specific magnet shapes.
- Whether to include testing considerations for magnets liberated from the subject magnet products, such as specified in ASTM F963.
- Whether the product scope is adequate, particularly regarding the current exemptions for loose or separable hazardous magnets in home/kitchen products and products intended for education/research, which do not also have purposes consistent with the subject

magnet products.

- Whether requirements for safety messaging and packaging are necessary for the subject magnet products with loose or separable small parts magnets, regardless of their magnetic flux index, or to a specified magnetic flux index below $50 \text{ kG}^2 \text{ mm}^2$.
- Information on the impact of the draft proposed rule on small businesses, including data on unit sales information for magnet sets and non-magnet set products with loose or separable hazardous magnets.
- Whether the Commission should consider anti-stockpiling provisions pertaining to the subject magnet products not compliant with the draft proposed rule, and any relevant supporting information.
- Additional data pertaining to magnet ingestions and the internal interaction hazard.
- Comments regarding the reasonableness of the 180-day effective date and recommendations for a different effective date, if justified. Comments recommending a longer effective date should clearly describe the problems associated with meeting the shorter effective date and the justification for a longer one.

III. Conclusion

Staff recommends that the Commission publish an NPR in the *Federal Register* that proposes to extend to the subject magnet products the magnet size and strength requirements established by ASTM F963; specifically, under the draft proposed rule, any loose or separable magnets in the subject magnet products must meet the following criteria: (1) each magnet must be too large to fit entirely within the small parts cylinder described in 16 CFR 1501.4; or (2) each magnet must have a flux index of less than $50 \text{ kG}^2 \text{ mm}^2$, as measured by the procedures for determining the magnetic attractive force described in ASTM F963. Staff also recommends that the Commission propose to amend part 1112 to include subject magnet products that are children's products in the list of children's product safety rules for which CPSC has issued NORs. Through these performance requirements staff seeks to effectively reduce the likelihood of children and teens ingesting hazardous magnets, and consequently reduce the risks of death and serious injuries associated with the internal interaction hazard. Staff considered existing standards and regulations, and alternative options for reducing the risk of this hazard, and concludes that the requirements recommended in this package are reasonably necessary to adequately address the hazard.

TAB A: Health Outcomes Following Exposure to Hazardous Magnets and Associated Medical Considerations



UNITED STATES
CONSUMER PRODUCT SAFETY COMMISSION
BETHESDA, MARYLAND 20814

Memorandum

Date: September 24, 2021

TO : Stephen Harsanyi, Engineering Psychologist
Hazardous Magnet Products Project Manager
Directorate for Engineering Sciences

THROUGH: Stefanie Marques, Ph.D., Supervisory Scientist
Division of Pharmacology and Physiology Assessment

FROM : John N. Stabley, Ph.D., Physiologist
Division of Pharmacology and Physiology Assessment

SUBJECT : Health Outcomes Following Exposure to Hazardous Magnets and Associated
Medical Considerations

I. Introduction

The particular focus of the draft notice of proposed rulemaking (NPR) is to address the threat of internal interaction hazards consequent to the introduction of small, powerful magnets (“hazardous magnets”; see Tab D, Paul 2021) into the body. For the purpose of the draft NPR, subject magnet products are hazardous magnets in products with one or more magnets that are loose or separable and designed, marketed, or intended to be used by consumers for entertainment, jewelry (including children’s jewelry), mental stimulation, stress relief, or a combination of these applications (see Executive Summary by Harsanyi 2021a). Additional explanation of the product scope and magnet characteristics relevant to the present NPR are available in the briefing memorandum (Boniface and Harsanyi 2021).

The subject magnet products addressed in this briefing package may be made from a composite of neodymium, iron, and boron (NIB). NIB magnets impart strong attractive forces relative to their size (Croat et al. 1984, Sagawa et al. 1984, Otjen et al. 2013, Kramer et al. 2015). In addition to rare-earth magnets (e.g., NIB composite, samarium cobalt composite), ferrite and hematite magnets have also been involved in the internal interaction injuries that are the focus of the draft NPR. Indeed, the same threat of injury and subsequent medical management exist with non-rare earth magnets (Otjen et al. 2013, Kramer et al. 2015). The aim of the draft NPR is to mitigate the risk of adverse health outcomes associated with subject magnet products, especially the internal interaction hazards associated with their ingestion, particularly among children and teenagers.

For the present memorandum, staff from the Directorate for Health Sciences (HS) at the U.S. Consumer Product Safety Commission (CPSC) describes injuries, treatments, and other medical factors related to the subject hazard that may occur as a consequence of internal interactions

between distinct elements of the subject products that are facilitated by their intrinsic magnetic properties. Briefly, the memorandum discusses the hazards associated with the ingestion of magnets, associated health outcomes, and corresponding medical treatments and interventions. Examples from the medical literature and select CPSC In-Depth Investigation (IDI) and Injury or Potential Injury Incident (IPII) reports are also used to illustrate possible health outcomes.

II. Background

Identification of Hazardous Magnets. In response to an increasing utilization of rare-earth magnets and their novel incorporation into consumer products, ASTM F963-07, *Standard Consumer Safety Specification for Toy Safety*, published in May 2007, introduced the notion of a hazardous magnet that could be identified by calculating the magnetic flux index from measurements of magnetic induction, also known as magnetic flux density (in kiloGauss, kG), and the area of the magnet pole surface (in millimeters squared). The magnetic flux index is the mathematical product of magnetic induction squared and the area of the magnetic pole about which the magnetic induction is measured. Hazardous magnets and hazardous magnet components are identified by ASTM F963 by the property of a magnetic flux index greater than or equal to $50 \text{ kG}^2 \text{ mm}^2$ (ASTM F963-16).⁴⁵ The CPSC toy standard (16 CFR part 1250) mandates compliance with ASTM F963-17.

Relationship Between Magnet Set Availability and Magnet Ingestions. Past activities regarding magnet ingestions at the CPSC [79 FR 59961 (October 3, 2014), 82 FR 46740 (October 6, 2017)] have focused on a subset of subject magnet products named magnet sets that are characterized as a collection of many small identical magnets. Population-based data from the National Electronic Injury Surveillance System (NEISS) demonstrate that trends in magnet set magnet ingestions among children aged 0-17 years old corresponds with availability of magnet sets in the marketplace (refer to the Briefing Memorandum by Boniface and Harsanyi 2021). Analysis revealed significant increases in small, round magnet ingestions and multiple magnet ingestions since 2016 when established CPSC regulations were vacated and the magnet sets again became available in the marketplace (Reeves et al. 2020). A separate evaluation of NEISS data revealed similar relationships between magnet set availability in the marketplace and the number of emergency department visits for magnet ingestions among children aged 0-17 years old (Flaherty et al. 2020). Although less specific to magnet set magnets and covering 0-19-year-old children, a separate population-based data set from the National Poison Data System confirmed the observed correspondence between marketplace availability and incidence of injury following magnet ingestion (Middelberg et al. 2021).

Foreign Bodies. Foreign body ingestion is relatively common (Arango et al. 2011, Lee 2018) and the types of foreign bodies ingested may vary according to the age of the involved individual (Arango et al. 2011). Most ingested foreign bodies pass naturally (Arango et al. 2011, Lee 2018, Otjen et al. 2013), but those that do not pass naturally most commonly result in lacerations, perforations, impactions, and obstructions of the alimentary canal that depend on the type of foreign body ingested and its configuration relative to the intrinsic anatomical features across the length of the gastrointestinal (GI) tract (Arango et al. 2011). For example, the North American Society for Pediatric Gastroenterology, Hepatology & Nutrition indicates that it is mandatory to

⁴⁵ ASTM committee F15 on consumer products established a magnetic flux index performance threshold of $50 \text{ kG}^2 \text{ mm}^2$ to identify hazardous magnets in 2007 (ASTM F963-07).

remove foreign bodies located in the esophagus and that most of these esophageal foreign bodies require removal within two hours of presentation (Kramer et al. 2015).

Subject Hazard. Magnets are unique among ingested foreign bodies because of their intrinsic ability to attract to one another or to ferromagnetic objects. Assuming the same elemental composition, a magnet with large physical dimensions and mass can exhibit stronger attractive forces than a magnet with small physical dimensions and mass. Similarly, individual magnets coupled together can exhibit greater attractive strengths than individual magnets alone. Distinct aggregations of multiple individual magnets have been observed in medically-treated internal interaction injuries (see IPII I18C0106A). Edwards and Edwards (2017) noted a unique characteristic of small spherical NIB magnets of a type common in magnet sets wherein spherical magnets that are initially repulsive spontaneously reorient until they attract to each other. Such a relationship may increase the likelihood of internal magnet interaction. McCormick et al. (2002) outlined a mechanism of injury following magnet ingestion wherein separate magnets in adjacent tissue walls (*e.g.*, from distinct loops of bowel) attract to each other and trap tissue in between the magnets. The mechanism of injury is the same for a single hazardous magnet and a ferromagnetic object that might interact internally. As discussed by staff from the Division of Human Factors in the Directorate for Engineering Sciences at the CPSC, Health Canada's restriction on hazardous magnets in children's toys and other magnet products covers individual magnets due to the health risks posed by individual subject magnet products (Tab C, Harsanyi 2021b). Congruent with the apparent hazard, most work by CPSC staff thus far has focused on internal magnet interactions leading to pressure necrosis injuries that occur in the alimentary canal (*e.g.*, 79 FR 59961, 82 FR 46740). Necrosis is a process of cell death secondary to injury that undermines cell membrane integrity (Guyton and Hall 2006) and involves intricate cell signaling responses (Vanlangenakker et al. 2008). In the case of internal magnet interactions, the injury leading to necrosis is a pressure on the involved biological tissues that exceeds local capillary pressure and engenders ischemia (Agrawal and Chauhan 2012). Although previous work by HS staff focused on hazards associated with magnet sets (Inkster 2008, Inkster 2012, Inkster 2020), the scope of the draft NPR is expanded (refer to the Briefing Memorandum by Boniface and Harsanyi 2021) while the internal magnet interaction hazard and associated injury mechanism remain unchanged in principle.

III. Discussion

A. Health Outcomes Associated with the Subject Hazard

The variety of health threats posed by magnet ingestion have been discussed in detail in previous work by HS staff (Inkster 2012, Inkster 2020) and include volvulus, bowel obstruction, bleeding, pressure necrosis, fistulae, ischemia, inflammation, perforation, peritonitis, sepsis, ileus, ulceration, aspiration, and death among others. Furthermore, the normal functions of the GI tract including peristalsis are not likely to dislodge magnets that are attracted to each other through component tissues. In Australia, an 18-month-old child died after ingesting multiple magnets (Australian Competition and Consumer Commission 2012). Ambiguous symptomatology following magnet ingestion that results in an internal interaction injury may complicate the timely delivery of medical care (Hodges et al. 2017). Symptoms related to magnet ingestion may be characterized as flu-like and include vomiting, fever, and abdominal pain among others

(Hodges et al. 2017, see IDI 051213CCC3192). For example, symptomatology following magnet ingestion has been mistaken for a virus (IDI 140115CAA2304), ear infection, and bronchitis (see IDI 110311HCC3475). The presence or absence of a first-hand account (*e.g.*, reported by the victim or witnessed and reported by sibling, parent, friend, or other individual) of magnet ingestion may also impact the delivery of timely medical care (Hodges et al. 2017).

1. Internal Magnet Interaction Injuries

Volvulus is an obstructive twisting of the gastrointestinal tract that is also a possible outcome of magnet ingestion (İlçe et al. 2007). Volvulus following magnet ingestion has been linked to fatal outcomes. A 20-month-old male died following ingestion of magnets from a toy construction set that caused volvulus (IDI 051213CCC3192). An 8-year-old male died in Warsaw, Poland due to small intestine ischemia secondary to volvulus after ingesting magnets that resulted in necrosis, toxemia (blood poisoning), hypovolemic shock, and eventually cardiopulmonary failure (Olczak and Skrzypek 2015). A 2-year-old male died at home from small intestine ischemia secondary to volvulus following multiple magnet ingestion (IDI 181206CCC2102). Volvulus is often accompanied by abdominal pain, distended abdomen, vomiting, constipation, and bloody stools. Volvulus may lead to bowel ischemia, perforation, peritonitis, and death if left untreated (Le et al. 2021). Small intestine ischemia was implicated in the death of a 19-month-old female following ingestion of multiple magnets (IDI 140115CAA2304). Similar to outcomes related to volvulus, small bowel ischemia can lead to local tissue necrosis, perforation, and subsequent peritonitis (Diamond et al. 2019, Umphrey et al. 2008). Bowel obstruction, often a consequence of volvulus, is associated with abdominal cramps, vomiting, constipation, and distention (Kulaylat and Doerr 2001).

HS staff previously discussed the relationships among local capillary and intraluminal pressures and magnet ingestions (Inkster 2008). Subsequent outcomes include possible blockage of local blood and nutrient supply; progressive pressure necrosis of the involved tissues; and local inflammation, ulceration, and tissue death with putative outcomes such as perforation (hole) or fistula in the GI tract. If left untreated or otherwise unnoticed, such events can progress into infection, sepsis, and death (Inkster 2008). The obstruction from the trapped tissue can elicit vomiting, and the local mucosa irritation may stimulate diarrhea. Advancing pressure necrosis of the involved tissues can lead to necrosis and subsequent leakage of the bowel contents into the peritoneal cavity (McCormick et al. 2002). Taher et al. (2019) described the discovery of several fistulae in the intestines of an asymptomatic 4-year-old child that required surgical repair. Fistulae are abnormal passages between channels in the body (Falconi and Pederzoli 2001, Farooqi and Tuma 2021) that are associated with increased mortality (Falconi and Pederzoli 2001). Fistulae may enable the leakage of gut contents into adjacent tissue structures or abdominal cavities (Falconi and Pederzoli 2001) that can lead to infection, inflammation, perforation, sepsis, and possibly death (Farooqi and Tuma 2021). Fistulae may also bypass portions of the GI tract thus undermining normal GI function.

IPII report X2080913A describes a 28-month-old male that experienced stomach ulcerations following the ingestion of 10 small round magnets that were treated via medication after the endoscopic removal and natural passage of involved magnets. Untreated ulcers may require surgical intervention if they progress to perforation (Woolf and Rose 2021), and a perforated bowel may lead to leakage from the GI tract. Indeed, several accounts from CPSC reports

highlight the threat of perforation (e.g., IDI 191114CFE0001, IDI 200129CCC2236, IPII I12C0007A, IPII I1540449A) with possible outcomes such as peritonitis and death. A 15-month-old child died due to apparent cardiac arrest secondary to perforated bowel caused by ingested magnets (IPII I2180479A), and a 43-year-old male died from acute peritonitis following small bowel perforation associated with ingested magnets (IPII X2070057A). Peritonitis is an inflammation of the peritoneum, a membrane lining of the abdominal cavity, that may be associated with leakage from the GI tract that can lead to sepsis (Holzheimer 2001). Sepsis is the body's response to severe infection, and it is associated with elevated rates of morbidity and mortality that can be mitigated with prompt treatment (Canadian Agency for Drugs and Technologies in Health 2017, El-Wiher et al. 2011). Accordingly, treatment of abdominal sepsis may require repair of a leaky GI tract (Merrell and Latifi 2001).

IDI 210211CCC1373 is directly associated with a case reported in the medical literature (see Powers et al. 2021). A 3-year-old male ingested multiple small spherical magnets, two of which were found attracting to each other on opposing surfaces of the pharyngoepiglottic fold in the throat thus presenting an immediate aspiration threat due to the proximity to the airway (Powers et al. 2021). Aspiration of magnets has also been reported elsewhere in the medical literature (Solis et al. 2020, Xu et al. 2015). Foreign body aspiration presents a risk of airway obstruction, ventilatory difficulty, choking, hypoxic-ischemic brain injury, pulmonary hemorrhage, and death among others (Cramer et al. 2021).

2. Other Magnet Health Outcomes and Injuries

Foreign Body Irritation of the Gastrointestinal Tract. Ingested magnets that are not attracting to each other through tissue walls may still cause harm such as irritation of the GI mucosa (IDI 200707CCC3656) in the form of erythematous (mucosal redden; see IDI 190412CCC1369), mucosal inflammation (IDI 191015CCC1039), and minor tears (IDI 191114CFE0001). Ingested magnets embedded in the bowel may be associated with multiple days of hospitalization (IDI 190716CFE0001). A foreign body lodged in the GI tract can also cause mucosal wall deterioration, migration, and perforation. Comorbidities such as eosinophilic esophagitis, gastroesophageal reflux disease, GI anomalies, and neuromuscular disorders can all exacerbate the incidence of deleterious outcomes (Jaan and Mulita 2021). The wall of the esophagus is susceptible to edema and weakening that increase the risk of bleeding and perforation in the presence of foreign bodies (Jaan and Mulita 2021, Kim et al. 2017). Foreign body irritation of the GI tract may also prompt local mucosal irritation that can stimulate diarrhea (McCormick et al. 2002).

Toxicity. During their investigation of a medical device containing magnets to facilitate percutaneous gastrostomy, Grier et al. (1995) observed that neodymium is not likely to be toxic to the GI tract and that it is poorly absorbed there. Furthermore, a literature review by Rim et al. (2013) indicates that there is a low to moderate toxicity associated with neodymium compounds. The threat of strontium toxicity after ingestion of strontium ferrite magnets was considered in the clinic when a 22-year-old male swallowed several flexible adhesive magnets. Urine strontium levels were well above reference ranges but no apparent acute toxicity was noted, the magnets passed naturally, and urine strontium levels normalized within one week. The authors did not rule out the possibility of long-term strontium toxicity (Kirrane et al. 2006).

Other Magnet Interaction Injuries. The simulation of ear, nose, mouth, and genital piercings with subject magnets presents external magnet interaction risks that are unique but similar to internal magnet interaction injuries (McCormick et al. 2002). A 10-year-old male with attention deficit hyperactivity disorder (ADHD) experienced erosion of the nasal septum (a hole) subsequent to simulation of nose piercings and after failing to report the magnet interaction inside his nose for several weeks. Shortly after discovery of the magnets (two NIB magnets that were 2.5 mm in diameter and spherical in shape) via an unrelated orthodontic x-ray radiography exam, the magnets were removed with forceps in the presence of general anesthesia, and a hole in the nasal septum was expected to heal on its own. Notably, the initial application of suction to retrieve the magnets failed. Prior to removal, the male experienced headache and several nose bleeds (IDI 210223CCC3580). McCormick et al. (2002) also reported that the removal of magnets from body parts such as the nose and genitalia caused extensive pain and required sedation or general anesthesia to enable retrieval in some instances.

Medical Device Interference. Consumer magnets also may interfere with medical devices. For example, it is possible for magnets, including those containing neodymium (Wolber et al. 2007), to interfere with the normal operation of cardiac pacemakers (Jongnaragnsin et al. 2009, Ryf et al. 2018) and implantable cardioverter-defibrillators (see Jongnaragnsin et al. 2009). Pääkkönen and Korpinen (2018) presented data indicating that the distance between a magnetic object and an implanted medical device is an important factor driving interference such that the closer a magnetic object is to the implanted medical device, the more likely the potential for interference. In addition, toy magnets were shown to disrupt the normal function of a programmable Codman valve used to reduce the subdural pooling of cerebrospinal fluid following surgery to treat hydrocephalus (fluid buildup in the brain) in a 2-year-old male (Anderson et al. 2004).

3. Health Outcome Considerations

The impact of possible contemporaneous physiological and/or medical health states on deleterious, equivocal, or otherwise consequential health outcomes related to magnet ingestion incidents is complex. Certain comorbidities may be physiologically linked to deleterious outcomes following magnet ingestion injuries. For example, an increased risk of magnet ingestion has been associated with behavioral problems, developmental delays (Midgett et al. 2006, Oestreich 2009), history of pica (Oestreich 2009), autism (IDI 190412CCC1369, IDI 180718CFE0001, Midgett et al. 2006, Oestreich 2009, Otjen et al. 2013), attention deficit hyperactivity disorder (IDI 210223CCC3580, Midgett et al. 2006), down syndrome or trisomy 21 (Tachecí et al. 2006), intellectual disability, blindness (Henretig and Shannon 1998), learning disability (IDI 181212CBB3124), schizophrenia (Kirrane et al. 2006, Oestreich 2009), and depression (Otjen et al. 2013) among others (Oestreich 2009). Past medical history of abdominal surgery or surgery involving the bowel may also increase the risk of medical efforts to treat ingested magnets (IDI 181212CBB3124).

Anthropometry and Magnet Physical Characteristics. American Society for Gastrointestinal Endoscopy (ASGE) guidelines for pediatric endoscopy acknowledge the importance of physiologic age versus chronological age in the determination of treatment approaches as they relate to the size of anatomical structures and the size of ingested foreign bodies including magnets (Lightdale et al. 2014). For example, the anatomical and anthropometric features of distinct individuals of the same chronological age may not be the same due to intrinsic variations

in patterns of growth and development. With increasing size an ingested magnet alone or in aggregate after ingestion presents a threat of obstruction (Otjen et al. 2013, Mirza et al. 2015) or volvulus (Otjen et al. 2013). The possibility of obstruction, especially in the duodenum and jejunum, increases with the smaller anatomical dimensions associated with younger age (Vijaysadan et al. 2006). In general, foreign body ingestion and increasing age may be associated with an increased risk of complications such as bleeding mucosa or ulceration (Kim et al. 2017).

Time to Health Outcomes. The time between magnet ingestion and injury is variable and likely depends on a variety of factors including, but not limited to, the number of ingested magnets, awareness of the magnet ingestion by caregivers, awareness of the subject hazard by individuals or caregivers, whether or not multiple ingested magnets interact with each other inside of the body through tissue structures, and the configuration of coupled magnets relative to involved tissue structures. For example, a 20-month-old male died from volvulus secondary to magnet ingestion after approximately two days of reported flu-like symptoms (IDI 051213CCC3192). Elsewhere, a 12-year-old female who ingested magnets while simulating mouth piercings recovered following laparotomy and enterotomy to retrieve the magnets two days after ingestion (IDI 120321CWE2021). Medical professionals who become aware of the magnet ingestion (e.g., via oral report of the ingestion or diagnosis via x-ray radiography) may be able to minimize or avoid injury by way of prompt removal (e.g., via endoscopy; IDI 181212CBB3124, IDI 210208CCC1333). There have been several efforts to develop medical devices using magnets to deliberately compress and necrose target tissue and create healthy anastomoses (openings/passages) that connect or reconnect distinct channels in the body (Ersoz et al. 2016, Graves et al. 2017, Kamada et al. 2021, Pichakron et al. 2011, Toselli et al. 2017) including separate loops of bowel for certain surgical procedures. Although not pathological examples, the length of time required for successful anastomoses in preclinical medical device development settings ranged from multiple days (Wall et al. 2013) to weeks (Myers et al. 2010, Pichakron et al. 2011) as evaluated by necropsy (Myers et al. 2010) and passage of the magnet (Pichakron et al. 2011, Wall et al. 2013) after anastomosis formation. In a human trial, magnets passed naturally multiple weeks after placement to create healthy anastomoses (Graves et al. 2017). The preceding studies provide examples of the time to tissue necrosis in a controlled environment when magnetic compression is involved.

B. Medical Care for Subject Hazard Health Outcomes

The presence or absence of a first-hand account of magnet ingestion may impact the delivery of timely medical care (Hodges et al. 2017). Accordingly, the medical community has responded with proposed algorithms to help guide the management of these dangerous medical situations (Hussain et al. 2012, Otjen et al. 2013). In addition, the ASGE recommends removal of all ingested magnets that are accessible via endoscopy (Ikenberry et al. 2011). Similarly, more recent guidance from the ASGE recommends emergent removal when two or more rare-earth neodymium magnets have been ingested in the pediatric patient (Lightdale et al. 2014). The ASGE further notes that the complexities unique to distinct clinical cases will ultimately direct the course of care (Ikenberry et al. 2011, Lightdale et al. 2014). The use of medical procedures and surgery to treat magnet ingestions and/or associated injuries suggests that the intrinsic risk of surgery or other medical procedures is less than the risk of no medical intervention (see Chand et al. 2007).

1. Medical Procedures

According to incident reports, medical imaging is routinely deployed during treatment of magnet ingestions. Current imaging diagnostic capabilities may be able to identify ingested foreign bodies, but they do not allow for the definitive identification of magnets in the body. Concurrent and verified reports of magnet ingestion may improve the utility of medical imaging to identify magnets in the body. McCormick et al. (2002) reported that metal detectors were previously useful to locate ingested metallic objects including magnets, but that their utility decreased with a decrease in size of ingested magnets. In their review of the literature about GI injury subsequent to magnet ingestion, Liu and colleagues (2012) suggested the use of a compass held close to the abdomen to aid in the identification of unknown foreign bodies.

Medical Imaging. Without an oral history specifically identifying magnet ingestion, it may be difficult to conclude from medical imaging alone that the foreign bodies are magnets (Otjen et al. 2013). It may also be difficult to utilize medical imaging to determine if magnets are interacting internally through tissue structures (Otjen et al. 2013). For example, x-ray radiography reports early in the treatment course for a foreign body ingestion in a 10-year-old female described a “foreign body likely representing swallowed jewelry” in the bowel. Several magnets were later removed from the alimentary canal via two endoscopic procedures (IDI 181212CBB3124). X-ray radiography may be the most common medical imaging procedure used to monitor ingested magnets. Serial x-ray radiography is useful for monitoring the progress of a magnet or magnets through the GI tract. In the absence of symptoms, the magnet may be monitored until it passes naturally. If the passage of the magnets through the GI tract is arrested or if symptoms manifest, then endoscopic or surgical intervention may be indicated. Otjen et al. (2013) described a case in which a 10-year-old female swallowed two small spherical magnets that were first considered for endoscopic retrieval. Instead, the coupled magnets were monitored via x-ray radiography and passed naturally in the absence of symptomatology. Fluoroscopy is frequently used intraoperatively to augment efforts to retrieve ingested magnets, but it can also be used as an adjunct to x-ray radiography for monitoring the position of ingested magnets (see Otjen et al. 2013). Computed tomography (CT) scans may also be used to monitor ingested magnets (see İlçe et al. 2007). For example, CT scans of a 7-year-old male identified the location of an ingested magnet that could not be fully defined via x-ray radiography (Otjen et al. 2013). Kim et al. (2017) suggest that CT scans may be particularly useful if perforation is suspected. CT scans may also be useful in the management of bowel obstruction (Kulaylat and Doerr 2001). However, according to the U.S. Food and Drug Administration (FDA 2020a), the ionizing radiation associated with x-ray radiography has the potential to damage DNA and perhaps drive the development of cancer later in life. The risks from CT scans are similar while prolonged fluoroscopy – often used during surgery or medical procedures such as endoscopy – may contribute to the development of cataracts, skin reddening, and/or hair loss. Physicians used ultrasound to locate magnets in the appendix of a 5-year-old male prior to laparoscopic appendectomy to retrieve them (IDI 191015CCC1039). Ultrasound was also used to augment treatment of a 2-year-old female who ingested hematite magnets (Mirza et al. 2015), and ultrasound may be useful for diagnosing bowel obstruction (Kulaylat and Doerr 2001). According to the FDA (2020b), ultrasound, or sonography, is relatively safe. Ultrasound energy may heat tissue or produce pockets of gas in body fluids or tissues. Magnetic resonance imaging (MRI) must be avoided if overt magnet ingestion is suspected because of the powerful magnetic fields used for MRI that could interact with ingested magnets (Otjen et al. 2013). Avoiding the

use of MRI for the treatment of ingested magnets has also been noted by others (IDI 181212CBB3124, Taher et al. 2019).

Bowel Cleanout. Bowel cleanout, or bowel preparation, procedures that use laxatives such as polyethylene glycol may be used to try to flush ingested magnets out of the GI tract (IDI 200707CCC3655, IDI 200707CCC3656) and/or to prepare patients for endoscopy or other medical procedures (Dabaja et al. 2021). Bowel cleanout is not often associated with risk in the pediatric population, but dehydration is the most common adverse event that occurs (Pall et al. 2014). In certain instances, bowel cleanout laxatives may be delivered via nasogastric tube (IDI 200707CCC3655, IDI 200707CCC3656). There are rare reports of life-threatening aspiration of laxative solutions delivered via nasogastric tubes especially in older populations with certain comorbidities (Marschall and Bartels 1998).

Endoscopy. Endoscopy may be used to retrieve ingested magnets from the stomach (IPII I1440063A, IPII H1540133A), duodenum (IPII I17C0176A), esophagus, pylorus (IDI 180823CCC2979), and cecum (via colonoscopy, IDI 191114CFE0001) among other portions of the alimentary canal. Endoscopy may also be used to treat bowel obstruction (Kulaylat and Doerr 2001) secondary to magnet ingestion. Endoscopy is associated with a risk of bleeding from mucosal shearing or tearing that is elevated in the presence of anemia. There is also risk of adverse cardiopulmonary events (e.g., oxygen desaturation, aspiration, respiratory arrest, shock, myocardial infarction) as a result of sedation and anesthesia; perforation from procedure instruments; infection from contaminated equipment or from a perturbed endogenous source; and procedural risks largely associated with instances of comorbidities such as obesity, cardiac disease, and diabetes among others (Lightdale et al. 2019). The most important comorbidities that might complicate endoscopy are cardiopulmonary disorders, blood disorders, allergies, sepsis, and immunocompromise. Associated adverse events that require cessation of procedures include hypotension, hypertension, dysrhythmia, cardiac arrest, hypoxia, bronchospasm, and infection among others (Cotton et al. 2010). Colonoscopy is a common endoscopic procedure performed via the anus, and accordingly it shares many of the same risks as endoscopy in general (Kothari et al. 2019). Laryngoscopy is a medical procedure to evaluate the upper aerodigestive tract. Laryngoscopy was used to investigate suspected magnets lodged in the throat of a 3-year-old male (IDI 210211CCC1373 and Powers et al. 2021). Associated risks of laryngoscopy include esophageal perforation, airway compromise, bleeding, dysphagia, and fever among others (Hendrix et al. 1994). Nasal endoscopy may be useful to treat magnets embedded in the nose (IDI 210223CCC3580). Nasal endoscopy is associated with risks of mucosal irritation, minor hemorrhage, and overt hemorrhage (Mori et al. 2008).

2. Surgery

Surgical interventions may be used to treat magnet ingestions when less invasive procedures such as endoscopy or bowel cleanout prove clinically inappropriate or less successful (IDI 210309CCC1552). Accordingly, medical procedures may be converted into surgical procedures to improve medical treatment outcomes. The American College of Surgeons states that “surgery is performed for the purpose of structurally altering the human body by the incision or destruction of tissues and is a part of the practice of medicine” (American College of Surgeons 2007). This definition is reaffirmed by way of adoption by the American Medical Association in Policy H-475.98, Definition of Surgery.

When endoscopy failed to retrieve all of the ingested magnets from a 5-year-old male, the remaining magnets were recovered via laparotomy with appendectomy in one incident (see IDI 210309CCC1552). Abdominal surgeries such as laparotomy (abdominal incision) and laparoscopy (fiber-optic visualization of the viscera via abdominal incision) that involve abdominal incisions and manipulation of abdominal organs are associated with the risk of adhesions that can cause pain, bowel obstructions that may require additional surgical intervention, female infertility, and bowel injury (Okabayashi et al. 2014). Six months after enterotomy and gastrostomy to remove 26 rare-earth magnets from the jejunum and stomach, a 2-year-old female developed bowel adhesions that caused obstructions and required treatment with surgical adhesiolysis (Mandhan et al. 2014) to cut the adhesions (Nahirniak and Tuma 2021). In general, laparoscopy procedures may be associated with reduced incidents of wound infection, pneumonia, decreased procedure time, and decreased length of hospital stay compared to more invasive laparotomy procedures (Hajibandeh et al. 2016). Laparotomy alone is associated with complications such as pain; fever; nausea; infection of the surgical site; wound dehiscence (rupture); respiratory tract infection; complications involving the heart, kidney, and GI tract; and septicemia. In addition, emergency laparotomies may be more prone to complications than elective laparotomies (Ravishankar et al. 2020). Possible complications associated with laparotomy include pneumonia, cardiac complications, surgical site infection, urinary tract infection, venous thromboembolism, kidney failure, and death (Burgess et al. 2017). Indeed, a 6-year-old female underwent a 20-day hospital stay to treat surgical wound infections following exploratory laparotomy with small bowel resection and appendectomy to retrieve 20 ingested magnets (IPII I18B0438A). Appendectomy is commonly achieved via laparotomy (IDI 120321CWE2021) or laparoscopy. Pain, wound infections, and intra-abdominal abscesses are possible following both laparoscopic and open appendectomies (Jaschinski et al. 2018). Laparotomy may be accompanied by incisions of the stomach (gastrostomy; see IDI 200204CCC3277) or intestines (enterotomy; see IDI 120321CWE2021) to retrieve ingested magnets. Complications from surgical enterotomies, or incisions into the intestine, may be similar to those of inadvertent enterotomies that can occur during anastomosis procedures and might include leakage, mortality, and intra-abdominal abscesses (see Goulder 2012).

Surgical resection of the bowel may be performed to remove necrotic portions of the bowel secondary to magnet ingestion (IPII H19A0102A, IPII I1990335A, IPII I18B0438A). Small bowel resection is associated with risks of infection, fistulae, peritonitis, abscess, sepsis, and wound dehiscence secondary to leaky anastomoses. There is also the possibility of impairment to the intrinsic nutrient absorption functions of the bowel depending on the resection location (Clatterbuck and Moore 2020). End-to-end surgical anastomoses used to restore bowel continuity following resection are associated with the risk of leakage, intra-abdominal abscess, and mortality (Goulder 2012).

Complications associated with surgery to treat magnet ingestion have also included pancreatitis and additional hospitalization (IDI 120713CAA3752), additional surgery to treat incisional hernia (IDI 140115CAA1287), and the need for a lifelong feeding tube (IDI 200211CFE0002) among others (IDI 120419CBB3615). Endotracheal general anesthesia may be required for surgical treatments of magnet ingestion (IDI 210223CCC3580). Possible complications associated with general anesthesia include nausea, vomiting, sore throat, dental damage,

myocardial ischemia or infarction, heart failure, cardiac arrest, arrhythmia, atelectasis (lung collapse), aspiration, bronchospasm, neurological effects, and renal effects among others (Harris and Chung 2013).

3. Medical Care Considerations

Ingested magnets present unique challenges for medical professionals. McCormick et al. (2002) noted that technical precision was reduced and technical difficulty was increased when ingested magnets attracted to the metallic instruments used to retrieve them. For example, ingested magnets in the throat of a 3-year-old male suddenly attracted to the optic graspers inserted to retrieve the foreign bodies (Powers et al. 2021 and IDI 210211CCC1373). In a separate incident, a 9-year-old male was evaluated at a local emergency department after ingesting more than 100 three-millimeter (3 mm) diameter magnets. Shortly thereafter, the male was transferred by helicopter to a medical facility with more advanced medical care options. Health care providers instructed the flight crew to refrain from using metal clasps or buckles to secure the male in order to avoid possible interaction with the ingested magnets (IDI 200204CCC3227).

IV. Summary

HS staff recognizes the health threats associated with hazardous magnets, especially when the magnets are ingested and attracted to each other or to ferromagnetic objects through internal tissue structures. According to the available information, the ingestion of magnets is associated with medical treatments such as x-ray radiography, bowel cleanout, endoscopy, exploratory laparotomy, gastrotomy, fluoroscopy, and GI surgery among others. Certain medical procedures may be associated with health risks such as bleeding, infection, tissue injury, or adverse cardiopulmonary events among others. Related health outcomes possible with magnet ingestion include mucosal inflammation, volvulus, bowel obstruction, pressure necrosis, fistulae, tissue ischemia, inflammation, perforation, peritonitis, sepsis, ileus, ulceration, aspiration, and death among others. The possibility also exists for ingested magnets to pass naturally through the GI tract without medical intervention especially if only one magnet is ingested alone or if magnets are coupled together prior to ingestion. Prompt recognition of magnet ingestion and the associated hazard enable swift medical treatment that can mitigate adverse health outcomes such as injury or death. Delays between recognition of the magnet ingestion and appropriate medical treatment may occur due to the absence of first-hand reports or ambiguous symptomatology (Hodges et al. 2017). Contemporaneous physiological states and/or medical conditions may influence exposure to the magnet ingestion hazard (*e.g.*, learning disabilities) and physiological responses to treatment or injuries (*e.g.*, anemia).

V. References

- Agrawal, K. and Chauhan, N. Pressure ulcers: Back to the basics. *Indian Journal of Plastic Surgery: Official Publication of the Association of Plastic Surgeons of India*. 45(2):244-254, 2012.
- American College of Surgeons. Statement on surgery using lasers, pulsed light, radiofrequency devices, or other techniques. *Bulletin of the American College of Surgeons*. 92(4):37-38, 2007.
- Anderson, R. C., Walker, M. L., Viner, J. M., and Kestle, J. R. Adjustment and malfunction of a programmable valve after exposure to toy magnets: case report. *Journal of Neurosurgery: Pediatrics*. 101(2):222-225, 2004.
- Arango, L. A. Á., León Sierra, L. P., Martínez Gutiérrez, D. C., and Jurado Grisales, M. Incidental foreign body in the gastrointestinal tract: Report of three cases and literature review. *Revista Colombiana de Gastroenterología*. 26(4):316-327, 2011.
- ASTM International. *F963-07 Standard Consumer Safety Specification for Toy Safety*. DOI: 10.1520/F0963-07, 2007.
- ASTM International. *F963-16 Standard Consumer Safety Specification for Toy Safety*. DOI: 10.1520/F0963-16, 2016.
- ASTM International. *F963-17 Standard Consumer Safety Specification for Toy Safety*. DOI: 10.1520/F0963-17, 2017.
- Australian Competition and Consumer Commission. (2012, August 23). *WA: Dangerous magnets banned after child death and injuries*. Australian Competition and Consumer Commission. Retrieved September 23, 2021 from <https://www.productsafety.gov.au/news/wa-dangerous-magnets-banned-after-child-death-and-injuries>
- Boniface, D. and Harsanyi, S. Briefing Memorandum. *Notice of Proposed Rule for Hazardous Magnets*. Bethesda, MD: Office of Hazard Identification and Reduction, U.S. Consumer Product Safety Commission, 2021.
- Burgess, J. R., Smith, B., Britt, R., Weireter, L., and Polk, T. Predicting postoperative complications for acute care surgery patients using the ACS NSQIP surgical risk calculator. *The American Surgeon*. 83(7):733-738, 2017.
- Canadian Agency for Drugs and Technologies in Health. Recognition and Diagnosis of Sepsis in Adults: A Review of Evidence-Based Guidelines [Internet]. Ottawa, ON: Canadian Agency for Drugs and Technologies in Health; 2017 Jan 13.
- Chand, M., Armstrong, T., Britton, G., and Nash, G. F. How and why do we measure surgical risk? *Journal of the Royal Society of Medicine*. 100(11):508-512, 2007.
- Clatterbuck, B. and Moore, L. Small Bowel Resection. *StatPearls [Internet]*. Treasure Island (FL): StatPearls Publishing, 2020.

Cotton, P. B., Eisen, G. M., Aabakken, L., Baron, T. H., Hutter, M. M., Jacobson, B. C., Mergener, K., Nemcek, A., Petersen, B. T., Petrini, J. L., Pike, I. M., Rabeneck, L., Romagnuolo, J., and Vargo, J. J. A lexicon for endoscopic adverse events: report of an ASGE workshop. *Gastrointestinal Endoscopy*. 71(3):446-454, 2010.

Cramer, N., Jabbour, N., Tavarez, M. M., and Taylor, R. S. Foreign Body Aspiration. In: *StatPearls [Internet]*. Treasure Island, FL: StatPearls Publishing, 2021.

Croat, J. J., Herbst, J. F., Lee, R. W., and Pinkerton, F. E. Pr-Fe and Nd-Fe-based materials: A new class of high-performance permanent magnets. *Journal of Applied Physics*. 55(6):2078-2082, 1984.

Dabaja, A., Dabaja, A., and Abbas, M. Polyethylene Glycol. In: *StatPearls [Internet]*. Treasure Island, FL: StatPearls Publishing, 2021.

Diamond, M., Lee, J., and LeBedis, C. A. Small bowel obstruction and ischemia. *Radiol Clin North Am*. 57(4):689-703, 2019.

Edwards, B. F. and Edwards, J. M. Dynamical interactions between two uniformly magnetized spheres. *European Journal of Physics*. 38(1):015205, 2017.

El-Wiher, N., Cornell, T. T., Kissoon, N., and Shanley, T. P. Management and Treatment Guidelines for Sepsis in Pediatric Patients. *The Open Inflammation Journal*. 4(Suppl 1-M11):101–109, 2011.

Ersoz, G., Tekin, F., Bozkaya, H., Parildar, M., Turan, I., Karasu, Z., Ozutemiz, O., and Tekesin, O. Magnetic compression anastomosis for patients with a disconnected bile duct after living-donor related liver transplantation: a pilot study. *Endoscopy*. 48(07):652-656, 2016.

Falconi, M. and Pederzoli, P. The relevance of gastrointestinal fistulae in clinical practice: a review. *Gut*. 49(suppl 4):iv2-iv10, 2001.

Farooqi, N., and Tuma, F. Intestinal Fistula. In: *StatPearls [Internet]*. Treasure Island, FL: StatPearls Publishing, 2021.

Flaherty, M. R., Buchmiller, T., Vangel, M., and Lee, L. K. Pediatric magnet ingestions after federal rule changes, 2009-2019. *JAMA*. 324(20):2102-2104, 2020.

Graves, C. E., Co, C., Hsi, R. S., Kwiat, D., Imamura-Ching, J., Harrison, M. R., and Stoller, M. L. Magnetic compression anastomosis (magnamosis): first-in-human trial. *Journal of the American College of Surgeons*. 225(5):676-681, 2017.

Goulder, F. Bowel anastomoses: the theory, the practice and the evidence base. *World Journal of Gastrointestinal Surgery*. 4(9):208-213, 2012.

Grier, J. F., Ibach, M. B., Grafton, W. D., & Gholson, C. F. Ischemia-induced tissue remodeling: Magnetic enteral gastrostomy in a porcine model. *Gastrointestinal Endoscopy*. 42(4):354-357, 1995.

Guyton, A. and Hall, J. Textbook of medical physiology, 11th ed. Elsevier Inc., Philadelphia, Pennsylvania. 2006.

Hajibandeh, S., Hajibandeh, S., Gumber, A. O., and Wong, C. S. Laparoscopy versus laparotomy for the management of penetrating abdominal trauma: a systematic review and meta-analysis. *International Journal of Surgery*. 34:127-136, 2016.

Harris, M. and Chung, F. Complications of general anesthesia. *Clinics in Plastic Surgery*. 40(4):503-513, 2013.

Harsanyi, S. Executive summary. *Notice of Proposed Rule for Hazardous Magnets*. Bethesda, MD: Office of Hazard Identification and Reduction, U.S. Consumer Product Safety Commission, 2021.

Harsanyi, S. TAB C, Human factors assessment of hazardous magnet products. *Notice of Proposed Rule for Hazardous Magnets*. Bethesda, MD: Directorate for Engineering Sciences, U.S. Consumer Product Safety Commission, 2021.

Hussain, S. Z., Bousvaros, A., Gilger, M., Mamula, P., Gupta, S., Kramer, R., and Noel, R. A. Management of ingested magnets in children. *Journal of Pediatric Gastroenterology and Nutrition*. 55(3):239-242, 2012.

Hendrix, R. A., Ferouz, A., and Bacon, C. K. Admission planning and complications of direct laryngoscopy. *Otolaryngology—Head and Neck Surgery*. 110(6):510-516, 1994.

Henretig, F. and Shannon, M. An 11-year-old boy develops vomiting, weakness, weight loss and a neck mass. *Internet Journal of Medical Toxicology*. 1(2):13-15, 1998.

Hodges, N. L., Denny, S. A., and Smith, G. A. Rare-Earth Magnet Ingestion–Related Injuries in the Pediatric Population: A Review. *American Journal of Lifestyle Medicine*. 11(3):259-263, 2017.

Holzheimer, R. G. Management of secondary peritonitis. In: Holzheimer, R. G., Mannick, J. A., editors. *Surgical Treatment: Evidence-Based and Problem-Oriented*. Munich: Zuckschwerdt, 2001.

Ikenberry, S. O., Jue, T. L., Anderson, M. A., Appalaneni, V., Banerjee, S., Ben-Menachem, T., Decker, G. A., Fanelli, R. D., Fisher, L. R., Fukami, N., Harrison, M. E., Jain, R., Khan, K. M., Krinsky, M. L., Maple, J. T., Sharaf, R., Strohmeyer, L. and Dornitz, J. A. Management of ingested foreign bodies and food impactions. *Gastrointestinal Endoscopy*. 73(6):1085-1091, 2011.

İlçe, Z., Samsun, H., Mammadov, E., and Celayir, S. Intestinal volvulus and perforation caused by multiple magnet ingestion: report of a case. *Surgery Today*. 37(1):50-52, 2007.

Inkster, S. E. TAB B, Review and analysis of the medical literature on magnet-specific injuries (MSIs); description of the gastrointestinal tract structure and function in relation to an analysis of the likely intestinal injury mechanisms involved in MSIs; comments on existing standards defining hazardous magnets, and suggested future considerations. *HS Memorandum from magnet team status update package for upper management*. Bethesda, MD: Directorate for Health Sciences, U.S. Consumer Product Safety Commission, 2008.

Inkster, S. E. TAB C, Assessment of injuries, complications, and acute and long-term health effects related to ingestion of magnets from magnet sets. *Notice of Proposed Rulemaking for Hazardous Magnet Sets*. Bethesda, MD: Directorate for Health Sciences, U.S. Consumer Product Safety Commission, 2012.

Inkster, S. E. TAB C, Petition Requesting Rulemaking on Magnet Sets: Health Sciences Considerations and Response to Public Comments. *Informational Briefing Package Regarding Magnet Sets*. Bethesda, MD: Directorate for Health Sciences, U.S. Consumer Product Safety Commission, 2020.

Jaan, A. and Mulita, F. Gastrointestinal Foreign Body. *StatPearls [Internet]*. Treasure Island, FL: StatPearls Publishing, 2021.

Jaschinski, T., Mosch, C. G., Eikermann, M., Neugebauer, E. A., and Sauerland, S. Laparoscopic versus open surgery for suspected appendicitis. *Cochrane Database of Systematic Reviews*. (11): Art. No. CD001546, 2018.

Jongnarangsin, K., Thaker, J. P., and Thakur, R. K. Pacemakers and magnets: An arranged marriage. *Heart Rhythm*. 6(10):1437-1438, 2009.

Kamada, T., Ohdaira, H., Takeuchi, H., Takahashi, J., Ito, E., Suzuki, N., Narihio, S., Yoshida, M., Yamanouchi, E., and Suzuki, Y. New Technique for Magnetic Compression Anastomosis Without Incision for Gastrointestinal Obstruction. *Journal of the American College of Surgeons*. 232(2):170-177, 2021.

Kim, S. I., Lee, K. M., Choi, Y. H., and Lee, D. H. Predictive parameters of retained foreign body presence after foreign body swallowing. *Am J Emerg Med*. 35(8):1090-1094, 2017.

Kirrane, B. M., Nelson, L. S., and Hoffman, R. S. Massive strontium ferrite ingestion without acute toxicity. *Basic & Clinical Pharmacology & Toxicology*. 99(5):358-359, 2006.

Kothari, S. T., Huang, R. J., Shaukat, A., Agrawal, D., Buxbaum, J. L., Fehmi, S. M. A., Fishman, D. S., Gurudu, S. R., Khashab, M. A., Jamil, L. H., Jue, T. L., Law, J. K., Lee, J. K., Naveed, M., Qumseya, B. J., Sawhney, M. S., Thosani, N., Yang, J., DeWitt, J. M., and Wani, S. ASGE review of adverse events in colonoscopy. *Gastrointestinal Endoscopy*. 90(6):863-876, 2019.

Kramer, R. E., Lerner, D. G., Lin, T., Manfredi, M., Shah, M., Stephen, T. C., Gibbons, T. E., Pall, H., Sahn, B., McOmber, M., Zacur, G., Friedlander, J., Quiros, A. J., Fishman, D. S., and Mamula, P. Management of ingested foreign bodies in children: a clinical report of the NASPGHAN Endoscopy Committee. *Journal of Pediatric Gastroenterology and Nutrition*. 60(4):562-574, 2015.

Kulaylat, M. N. and Doerr, R. J. Small bowel obstruction. In: Holzheimer, R. G., Mannick, J. A., editors. *Surgical Treatment: Evidence-Based and Problem-Oriented*. Munich, DE: Zuckschwerdt, 2001.

Le, C. K., Nahirniak, P., Anand, S., and Cooper, W. Volvulus. In: *StatPearls [Internet]*. Treasure Island, FL: StatPearls Publishing, 2021.

Lee, J. H. Foreign body ingestion in children. *Clinical Endoscopy*. 51(2):129-136, 2018.

Lightdale, J. R., Acosta, R., Shergill, A. K., Chandrasekhara, V., Chathadi, K., Early, D., Evans, J. A., fanelli, R. D., Fisher, D. A., Fonkalsrud, L., Hwang, J. H., Kashab, M., Muthusamy, V. R., Pasha, S., Saltzman, J. R. and Cash, B. D. Modifications in endoscopic practice for pediatric patients. *Gastrointestinal Endoscopy*. 79(5):699-710, 2014.

Lightdale, J. R., Liu, Q. Y., Sahn, B., Troendle, D. M., Thomson, M., and Fishman, D. S. Pediatric endoscopy and high-risk patients: a clinical report from the NASPGHAN endoscopy committee. *Journal of Pediatric Gastroenterology and Nutrition*. 68(4):595-606, 2019.

- Liu, S., Li, J., and Lv, Y. Gastrointestinal damage caused by swallowing multiple magnets. *Frontiers of Medicine*. 6(3):280-287, 2012.
- Mandhan, P., Alsalihi, M., Mammoo, S., and Ali, M. J. Troubling toys: rare-earth magnet ingestion in children causing bowel perforations. *Case Reports in Pediatrics*. 908730, 2014.
- Marschall, H. U., and Bartels, F. Life-threatening complications of nasogastric administration of polyethylene glycol-electrolyte solutions (Golytely) for bowel cleansing. *Gastrointestinal Endoscopy*. 47(5):408-410, 1998.
- McCormick, S., Brennan, P., Yassa, J., and Shawis, R. Children and mini-magnets: an almost fatal attraction. *Emergency Medicine Journal*. 19(1):71-73, 2002.
- Merrell, R. C., and Latifi, R. The abdomen as a source of sepsis in critically ill patient. In: Holzheimer, R. G., Mannick, J. A., editors. *Surgical Treatment: Evidence-Based and Problem-Oriented*. Munich, DE: Zuckschwerdt, 2001.
- Middelberg, L. K., Funk, A. R., Hays, H. L., McKenzie, L. B., Rudolph, B., and Spiller, H. A. Magnet Injuries in Children: An Analysis of the National Poison Data System from 2008 to 2019. *The Journal of Pediatrics*. 232:251-256, 2021.
- Midgett, J., Inkster, S., Rauchschalbe, R., Gillice, M., and Gilchrist, J. Gastrointestinal injuries from magnet ingestion in children--United States, 2003-2006. *MMWR: Morbidity and Mortality Weekly Report*. 55(48):1296-1300, 2006.
- Mirza, M. B., Bux, N., Talat, N., and Saleem, M. Multiple singing magnet ingestion leading to pressure necrosis of the small bowel. *Journal of Indian Association of Pediatric Surgeons*. 20(2):90-91, 2015.
- Mori, A., Ohashi, N., Maruyama, T., Ito, M., Miyawaki, T., and Okuno, M. A proposal for grading nasomucosal injury as a complication of transnasal endoscopy. *Endoscopy*. 40(S 02):E60-E60, 2008.
- Myers, C., Yellen, B., Evans, J., DeMaria, E., and Pryor, A. Using external magnet guidance and endoscopically placed magnets to create suture-free gastro-enteral anastomoses. *Surgical Endoscopy*. 24(5):1104-1109, 2010.
- Nahirniak, P., and Tuma, F. Adhesiolysis. In: *StatPearls [Internet]*. Treasure Island, FL: StatPearls Publishing, 2021.
- Oestreich, A. E. Worldwide survey of damage from swallowing multiple magnets. *Pediatric Radiology*. 39(2):142-147, 2009.
- Okabayashi, K., Ashrafian, H., Zacharakis, E., Hasegawa, H., Kitagawa, Y., Athanasiou, T., and Darzi, A. Adhesions after abdominal surgery: a systematic review of the incidence, distribution and severity. *Surgery Today*. 44(3):405-420, 2014.
- Olczak, M. and Skrzypek, E. A case of child death caused by intestinal volvulus following magnetic toy ingestion. *Legal Medicine*. 17(3):184-187, 2015.
- Otjen, J. P., Rohrmann, C. A., and Iyer, R. S. Imaging pediatric magnet ingestion with surgical-pathological correlation. *Pediatric Radiology*. 43(7):851-859, 2013.

Pääkkönen, R., and Korpinen, L. 1322 Exposure to static magnetic fields and disturbances of active implantable medical devices. *Occupational and Environmental Medicine*. 75(Suppl_2), 2018.

Pall, H., Zacur, G. M., Kramer, R. E., Lirio, R. A., Manfredi, M., Shah, M., Stephen, T. C., Tucker, N., Gibbons, T. E., Sahn, B., McOmber, M., Friedlander, J., Quiros, J.A., Fishman, D. S., and Mamula, P. Bowel preparation for pediatric colonoscopy: report of the NASPGHAN endoscopy and procedures committee. *Journal of Pediatric Gastroenterology and Nutrition*. 59(3):409-416, 2014.

Paul, C. TAB D, Recommended Performance Requirements to Address Ingestion Injuries Associated with Hazardous Magnets. *Notice of Proposed Rulemaking for Hazardous Magnets*. Bethesda, MD: Directorate for Engineering Sciences, U.S. Consumer Product Safety Commission, 2021.

Pichakron, K. O., Jelin, E. B., Hirose, S., Curran, P. F., Jamshidi, R., Stephenson, J. T., Fechter, R., Strange, M. and Harrison, M. R. Magnamosis II: magnetic compression anastomosis for minimally invasive gastrojejunostomy and jejunajejunostomy. *Journal of the American College of Surgeons*. 212(1):42-49, 2011.

Powers, E., Oluabunwa, E., Salehi, P. P., and Baum, C. R. Small Rare Earth Magnets Adhered to Pharyngeal Tissue in a Pediatric Emergency Department Patient. *The Journal of Emergency Medicine*. 60(4):e85-e88, 2021.

Ravishankar, N., Sah, S. K., Shivkumar, S., Arjun, M., and Shenoy, M. Comparative study of postoperative complications in elective versus emergency laparotomy at JSS hospital. *International Journal of Surgery*. 4(2):233-236, 2020.

Reeves, P. T., Rudolph, B., and Nylund, C. M. Magnet Ingestions in Children Presenting to Emergency Departments in the United States 2009–2019: A Problem in Flux. *Journal of Pediatric Gastroenterology and Nutrition*. 71(6):699-703, 2020.

Rim, K. T., Koo, K. H., and Park, J. S. (2013). Toxicological evaluations of rare earths and their health impacts to workers: a literature review. *Safety and Health at Work*. 4(1):12-26, 2013.

Ryf, S., Wolber, T., Duru, F., & Luechinger, R. Interference of neodymium magnets with cardiac pacemakers and implantable cardioverter-defibrillators: an in vitro study. *Technology and Health Care*. 16(1):13-18, 2008.

Sagawa, M., Fujimura, S., Togawa, N., Yamamoto, H., and Matsuura, Y. New material for permanent magnets on a base of Nd and Fe. *Journal of Applied Physics*. 55(6):2083-2087, 1984.

Solis, R. N., Lenes-Voit, F., Mitchell, R. B., and Shah, G. Rare earth metal magnets: an unusual airway foreign body. *Ear, Nose & Throat Journal*. 99(8):NP87-NP88, 2020.

Tachecí, I., Králová, M., Osoha, V., and Bureš, J. Ingestion of multiple magnets in a child with Down syndrome. *Folia Gastroenterol Hepatol*. 4(4):171-174, 2006.

Taher, H., Azzam, A., Khowailed, O., Elseoudi, M., Shaban, M., and Eltagy, G. A case report of an asymptomatic male child with multiple entero-enteric fistulae post multiple magnet ingestion. *International Journal of Surgery Case Reports*. 58:50-53, 2019.

Toselli, L., Martinez-Ferro, M., Cervio, G., Kwiat, D., Imamura-Ching, J., Graves, C. E., Gaston, B., and Harrison, M. Magnetic compression anastomosis (magnamosis) for functional undiversion of ileostomy in

pediatric patients. *Journal of Laparoendoscopic & Advanced Surgical Techniques*. 27(12):1314-1317, 2017.

Umphrey, H., Canon, C. L., and Lockhart, M. E. Differential diagnosis of small bowel ischemia. *Radiologic Clinics of North America*. 46(5):943-952, 2008.

U.S. Food and Drug Administration. Medical X-ray Imaging. 2020 September 28.
<https://www.fda.gov/radiation-emitting-products/medical-imaging/medical-x-ray-imaging>

U.S. Food and Drug Administration. Ultrasound Imaging: FDA. 2020 September 28.
<https://www.fda.gov/radiation-emitting-products/medical-imaging/ultrasound-imaging>

Vanlangenakker, N., Berghe, T. V., Krysko, D. V., Festjens, N., and Vandenamee, P. Molecular mechanisms and pathophysiology of necrotic cell death. *Current Molecular Medicine*. 8(3):207-220, 2008.

Vijaysadan, V., Perez, M., and Kuo, D. Revisiting swallowed troubles: intestinal complications caused by two magnets—a case report, review and proposed revision to the algorithm for the management of foreign body ingestion. *The Journal of the American Board of Family Medicine*. 19(5):511-516, 2006.

Wall, J., Diana, M., Leroy, J., Deruijter, V., Gonzales, K. D., Lindner, V., Harrison, M., and Marescaux, J. MAGNAMOSIS IV: Magnetic compression anastomosis for minimally invasive colorectal surgery. *Endoscopy*. 45(08):643-648, 2013.

Wolber, T., Ryf, S., Binggeli, C., Holzmeister, J., Brunckhorst, C., Luechinger, R., and Duru, F. Potential interference of small neodymium magnets with cardiac pacemakers and implantable cardioverter-defibrillators. *Heart Rhythm*. 4:e1-4, 2007.

Woolf, A., and Rose, R. Gastric Ulcer. In: *StatPearls [Internet]*. Treasure Island, FL: StatPearls Publishing, 2021.

Xu, J., Liu, D., Huang, Z., and Ke, K. Small magnet aspiration as a pediatric emergency: a case report. *International Journal of Clinical and Experimental Medicine*. 8(10):19561–19565, 2015.

**TAB B: NEISS Estimates and Analysis of CPSRMS Reported Incidents
Related to Ingestion of Magnets**



UNITED STATES
CONSUMER PRODUCT SAFETY COMMISSION
BETHESDA, MARYLAND 20814

Memorandum

Date: September 12, 2021

TO : Stephen Harsanyi
Hazardous Magnet Products Project Manager
Directorate for Engineering Sciences

THROUGH : Risana Chowdhury
Director, Division of Hazard Analysis
Directorate for Epidemiology

FROM : John Topping
Mathematical Statistician
Division of Hazard Analysis

SUBJECT : NEISS Estimates and Analysis of CPSRMS Reported Incidents Related to
Ingestion of Magnets

I. Introduction

Staff of the U.S. Consumer Product Safety Commission (CPSC) recommends addressing, through rulemaking, the internal interaction hazard associated with the ingestion of hazardous magnets by children and teens. This memorandum provides estimates for emergency department-treated, magnet-related ingestions from January 1, 2010 through December 31, 2020, obtained through the National Electronic Injury Surveillance System (NEISS).⁴⁶ This memorandum also characterizes attributes of various magnet ingestions, as described in reports collected in the Consumer Product Safety Risk Management System (CPSRMS)⁴⁷ database, with incident dates of January 1, 2010 through December 31, 2020. The data were extracted on January 8, 2021.

⁴⁶ Data from NEISS is based on a nationally representative probability sample of about 100 hospitals in the United States and its territories. NEISS data can be accessed from the CPSC webpage under the "Access NEISS" link at: <https://www.cpsc.gov/Research--Statistics/NEISS-Injury-Data>.

⁴⁷ CPSRMS is the epidemiological database that houses all anecdotal reports of incidents received by CPSC, "external cause"-based death certificates purchased by CPSC, all in-depth investigations of these anecdotal reports, as well as investigations of select NEISS injuries. Examples of documents in CPSRMS include: hotline reports, Internet reports, news reports, medical examiner's reports, death certificates, retailer/manufacturer reports, and documents sent by state/local authorities, among others.

Staff recommends addressing hazards associated with products with one or more magnets that are loose or separable, and designed, marketed, or intended to be used by consumers for entertainment, jewelry (including children’s jewelry), mental stimulation, stress relief, or a combination of these purposes (“subject magnet products”). The subject magnet products do not include “children’s toys,” subject to the requirements specified in ASTM F963 (16 CFR part 1250).⁴⁸ In addition, because “subject magnet products” are limited to products intended for amusement and jewelry, products, such as home and kitchen magnets (*e.g.*, hardware magnets and magnetic shower curtains), and magnet products intended only for education and research, are also out-of-scope of the draft proposed rule.

Discussed in this memorandum, and assessed further in the memorandum from staff of the Division of Human Factors, Directorate for Engineering Sciences (ESHF), Tab C, staff found that although some of the incident data identify the involved products with a reasonable degree of certainty, such as magnet sets intended for adult amusement,⁴⁹ much of the incident data lack certainty in identification of involved products. Unlike many other products under CPSC’s jurisdiction, often it is not readily identifiable what product was the source of injury in a magnet ingestion case—medical providers or caregivers may know that one or more magnet(s) was/were ingested, but may not know the product the magnet(s) came from. In general, where product type was identified or described, incidents typically involved products for used for amusement or as jewelry, such as magnetic desk toys and magnetic faux piercings/studs. Similarly, where an interaction scenario was reported, incident reports overwhelmingly indicated that victims were playing with the magnets or were using them to simulate mouth piercings at the time of the ingestions. Staff is particularly concerned about magnet sets, because their involvement in ingestion injuries is well-documented, including in previous CPSC staff packages, such as the 2014 rule on magnet sets (79 FR 59962) and the 2020 informational briefing package regarding magnet sets.⁵⁰

This memorandum considers all magnet ingestion injuries and magnet ingestion incidents, excluding products categorized by staff as out-of-scope of the draft proposed rule, because it is not possible to determine the exact product characteristics for every known magnet ingestion. The products and classifications discussed in this memorandum expand beyond what was discussed in prior rulemaking efforts on magnet sets. Therefore, this memorandum, and the terms used, should not be confused with prior staff memoranda, such as the 2012 memorandum, “*NEISS estimates and analysis of reported incidents related to ingestion of small, strong magnets that are part of a set of magnets of various sizes*” (Garland, 2012).

⁴⁸ ASTM F963, *Standard Consumer Safety Specification for Toy Safety*, which is mandated by 16 CFR part 1250, has requirements pertaining to objects designed, manufactured, or marketed as a plaything for children under 14 years of age. This mandatory standard includes requirements pertaining to “hazardous magnets,” which are identified as being small enough to fit entirely within the small parts cylinder specified in the standard and having a flux index of 50 kG² mm² or higher.

⁴⁹ Consistent with the 2014 rule on magnet sets (79 FR 59962), magnet sets are aggregations of separable magnetic objects that are marketed or commonly used as a manipulative or construction item for entertainment, such as puzzle working, sculpture building, mental stimulation, or stress relief. See Briefing Package: Final Rule on Safety Standard for Magnet Sets (2014): https://cpsc.gov/s3fs-public/pdfs/foia_SafetyStandardforMagnetSets-FinalRule.pdf.

⁵⁰ CPSC staff’s informational briefing package regarding magnet sets, “Staff Briefing Package In Response to Petition CP 17-1, Requesting Rulemaking Regarding Magnet Sets,” dated June 3, 2020: [https://cpsc.gov/s3fs-public/Informational Briefing Package Regarding Magnet Sets.pdf?FKVcZpHmPKWCZNb7JE16Ir0a31WV72PI](https://cpsc.gov/s3fs-public/Informational%20Briefing%20Package%20Regarding%20Magnet%20Sets.pdf?FKVcZpHmPKWCZNb7JE16Ir0a31WV72PI).

Although more details are provided in the body of this memorandum, some findings follow:

NEISS Estimates 2010-2020 Summary:

- There were an estimated 23,700 emergency department-treated magnet ingestions involving magnet products of various types.
- About 5 percent of these cases indicated categories of magnets not the subject of this rulemaking, and therefore, they were excluded from most further analyses, which focus on the estimated remaining 22,500 magnet ingestions.
- An estimated 4,200 victims (19% of 22,500) were hospitalized or transferred to another hospital after treatment.
- The middle 3 years (2014 through 2016)⁵¹ show significantly fewer of these magnet ingestions (estimated 1,300 per year) compared with earlier and more recent years (*e.g.*, compared with 2,300 per year from 2010 through 2013 and 2,300 per year from 2017 through 2020).

CPSRMS Reported Incidents 2010-2020 Summary:

- Staff received 284 reports of magnet ingestions.
- Of all 284 reported incidents, 3 (1.1%) resulted in death,⁵² and 184 (65.8%) resulted in hospitalization.
- At least 11 incidents (3.9%) involved victims 14 years or older.
- Only 27 of the 284 (9.5%) reported magnet ingestions could be determined as not involving products in the scope of this rulemaking.
- The remaining 257 (90.5%) involve magnets for which the subject products could not be ruled out based on available reports and investigations.

II. Discussion

NEISS Estimates Analysis

Staff considered magnet-related ingestion cases in the NEISS database with treatment dates from January 1, 2010 through December 31, 2020, before removing cases determined irrelevant or too uncertain (using the criteria below). To gather all possible data related to the magnets of interest, staff implemented a keyword search and considered any case that mentioned “magnet” or other keywords⁵³ in the narrative field. This was completed across all products. Unless otherwise noted, all estimates span the 2010 through 2020 timeframe. From this master set, cases were *excluded* from the analysis, if any of the following applied:

⁵¹ These middle 3 years include a period that the 2014 rule was in effect before the court vacated the rule. Potential implications of these findings are discussed in Tabs C and E.

⁵² Deaths outside the United States and deaths that occurred outside this 2010 through 2020 period are not included here, but they are discussed by other memoranda in this briefing package.

⁵³ Other keywords searched include “science kit,” “experiment,” and some specific brand product names of known subject magnet products. Staff searched for cases referring to “science kit” and “experiment” to determine potential involvement in ingestion incidents of out-of-scope products subject to ASTM F963; ASTM F963 currently exempts from performance requirements products identified in the standard as “magnetic/electrical experimental sets,” which are sometimes referred to as “science kits.”

- Any case that could not be determined to be magnet related, for example, “5YOF, acc swallowed dog toy vs magnet . . .”;
- Any case with no ingestion, or with uncertainty as to whether any ingestion actually occurred;
- Any case with ambiguity about whether what was ingested included at least one *magnet*.

Consequently, cases describing “possible ingestion” or “may have ingested” are excluded, unless a final diagnosis confirming ingestion was explicit. Staff also excluded a few cases involving a magnet and a diagnosed ingestion, when staff was unable to discern whether the magnet was the object ingested. Collectively, the above criteria may have excluded some ingestions of in-scope magnets.

CPSC staff categorized the resulting data set to assess the involvement of specific magnet product types in magnet ingestion cases. Based on the identification and/or description of the products involved in the cases, staff organized the cases into the following magnet categories: “magnet set,” “magnet toy,” “jewelry,” “science kit,” “home/kitchen,” “F963 magnet toy,” and “unidentified,” as described below.

- *Magnet Set*: Magnets from sets of loose-as-received ingestible magnets that are marketed or commonly used as a manipulative or construction item for entertainment, such as puzzle working, sculpture building, mental stimulation, or stress relief. These items met at least one of the following criteria: referred to as a magnet set or identified as a magnet set through product name. This excludes building sets with plastic and/or ferromagnetic components, unless otherwise identified as a magnet set. This also excludes products reasonably identified as belonging to the other product types described below (e.g., a magnetic clasp from a necklace).
- *Magnet Toy*: Magnets from products referred to as toys or games. This count includes products for which the manufacturer-intended user of the toy was an adult or unknown, and it excludes cases that positively identified toys subject to ASTM F963 (i.e., excludes products confirmed to have been designed, manufactured, or marketed as playthings for children under 14 years of age).
- *Jewelry*: Magnets described as jewelry and not definitively identified as a magnet set. Most of these cases involve magnets described as a bracelet, necklace, or piercing jewelry.
- *Science Kit*: Magnets from products identified as a science kit or magnetic/electrical experimental set.⁵⁴
- *Home/Kitchen*: Magnets from products such as non-toy magnet decorations, shower curtains, hardware, and kitchen products. Many of these cases specifically refer to the magnets as “kitchen magnets.”

⁵⁴ Detailed in Tab C, staff reviewed the incident reports for the involvement of products subject to the performance requirements exemption in ASTM F963 for magnetic/electrical experimental sets, which therefore, would be considered out-of-scope of the draft proposed rule. These children’s toys, which combine magnetism and electricity, such as electrical motors and doorbells, are sometimes referred to as “science kits.” Staff identified in the data one case that vaguely referred to a “science kit.”

- *F963 Magnet Toy*: Magnets from toys subject to ASTM F963 (*i.e.*, products designed, manufactured, or marketed as playthings for children under 14 years of age). Reports for these cases included brand names or other information sufficient for staff to identify the involved products as toys subject to ASTM F963.
- *Unidentified*: Magnets from unidentified products, although product characteristics and use patterns typically shared commonalities with subject magnet products.

Shown in **Tables 1** and **2** below, CPSC staff combined cases in the above magnet categories into groupings, as follows:

- “Amusement/Jewelry” – Cases involving “magnet sets,” “magnet toys,” or “jewelry”;
- “Unidentified” – Cases involving “unidentified” magnet products;
- “Exclusions” – Cases involving “home/kitchen” products, “F963 magnet toys,” or “science kits.”

Cases grouped as “amusement/jewelry” involved products identified or described consistent with the subject magnet products, such as magnetic desk toys and faux piercings/studs. Staff considered the use of the product in determining the most appropriate grouping. For example, magnets described as piercing jewelry, but with no other information, were considered “jewelry”; although some portion of these cases may have involved a magnet set or other magnet product.

Cases grouped as “unidentified” had insufficient information to identify the magnet product category, although product characteristics and use patterns may share commonalities with subject magnet products. Staff was conservative in grouping the majority of the NEISS cases as “unidentified.” These cases typically lacked product identifying information beyond the ingested object being a magnet, such as a small, round magnet; however, considering the distributions among these and other categories, staff finds it likely that a substantial proportion of the unidentified magnet products were subject magnet products.

Cases grouped as “exclusions” involved products identified or described to be for purposes other than for amusement or jewelry, or that are already subject to ASTM F963, and therefore, are excluded from the draft proposed rule. For example, many of the “home/kitchen” products were shower curtains with a single magnet that was liberated and swallowed. As explained in Tab C, “home/kitchen” products and “F963 magnet toys” were rarely involved in internal interaction incidents and the common hazard pattern of use as jewelry. There was a single case involving a product referred to as a “science kit,” and staff finds it plausible that the product was intended for education and research, and may have been a children’s toy subject to ASTM F963 (explained in Tab C, magnetic/electrical experimental sets subject to ASTM F963 are often referred to as “science kits”).

Table 1 provides the number of cases for each original category and how they were combined; and **Table 2** provides the overall estimates of emergency department-treated ingestions for the combined categories.

Table 1: Count of Magnet Ingestion Cases Treated in NEISS Hospital Emergency Departments by Magnet Category, 2010—2020

Original Magnet Category	N (Original)	Combined Magnet Category	N (Combined)
Magnet Set	58	Amusement/Jewelry	221
Jewelry*	53		
Magnet Toy	110		
Unidentified	793	Unidentified	793
Science Kit	1	Exclusions	58
F963 magnet toy	11		
Home/Kitchen	46		
Total	1,072	Total	1,072

*includes cases of uncertain product classification for which the magnets were being used as or like jewelry. Source: NEISS, CPSC.

Table 2: Estimated Number of Magnet-Related Ingestions Treated in Hospital Emergency Departments by Magnet Category, 2010—2020

Magnet Category	Estimate	CV	N
Amusement/Jewelry	4,400	0.17	221
Unidentified	18,100	0.14	793
Exclusions	1,300	0.20	58
Total	23,700	0.21	1,072

Source: NEISS, CPSC. Estimates rounded to the nearest 100. Throughout this section, summations of estimates may not add to the total estimates provided in the tables, due to rounding. Estimates are derived from data in the NEISS sample. Estimates spanning periods of multiple years (such as the 11 years from 2010 to 2020) are *not* annual averages.

Of the 23,700 magnet ingestions overall, at least an estimated 4,400 (18%) correspond to cases associated with Amusement/Jewelry, and an estimated 18,100 (76%) correspond to the Unidentified category. It is unknown what proportion of these are subject products. However, the estimated 1,300 (5%) injuries corresponding to exclusions (*i.e.*, identifying science kits, F963 magnet toys, or home kitchen products) can be presumed non-subject products. Combining only the Amusement/Jewelry and Unidentified categories, and omitting Exclusions, leaves us with a remaining total of 22,500 magnet ingestions, as shown in Table 3.

Table 3: Estimated Number of In-Scope Magnet-Related Ingestions Treated in Hospital Emergency Departments by Magnet Category, 2010—2020

Magnet Category	Estimate	CV	N
Amusement/Jewelry	4,400	0.17	221
Unidentified	18,100	0.14	793
Total	22,500	0.14	1,014

*Source: NEISS, CPSC.

Table 4 provides the annual estimates for these emergency department-treated, magnet-related ingestions by year from 2010 through 2020. Some of the year-to-year changes may be attributable to random variation in the sample; however, some differences are statistically

significant. Analysis of the NEISS data finds these estimated magnet ingestions in 2015 to be significantly less than for any of the years 2010, 2011, 2012, 2017, and 2018 (p-values = 0.037, 0.0066, 0.0129, 0.0285, 0.0046). Such analysis similarly finds these estimated magnet ingestions in 2016 to be significantly less than for any of the years 2011, 2017, and 2018 (p-values = 0.0319, 0.0202, 0.0271).

Table 4: Estimated Number of In-Scope* Magnet-Related Ingestions Treated in Hospital Emergency Departments by Year

Year	Estimate	CV	N
2010	1,900 ^a	0.18	91
2011	2,500 ^{a,b}	0.18	101
2012	2,700 ^a	0.26	115
2013	2,000	0.21	88
2014	**	**	62
2015	1,200	0.24	61
2016	1,400	0.24	77
2017	2,900 ^{a,b}	0.25	112
2018	2,400 ^{a,b}	0.18	120
2019	1,800	0.22	91
2020	2,200	0.21	96
Total	22,500	0.14	1,014

^a Estimate is significantly greater than for the year 2015 (p-value<0.05).

^b Estimate is significantly greater than for the year 2016 (p-value<0.05).

*These estimates exclude cases identifying non-subject-product-type magnets, and therefore, do *not* represent *all* magnet ingestions treated in hospital emergency departments.

**This estimate does not meet NEISS reporting criteria. For a NEISS estimate to satisfy all reporting criteria, the coefficient of variation (CV) cannot exceed 0.33, there must be at least 20 sample cases, and there must be at least 1,200 estimated injuries.

Source: NEISS, CPSC; estimates rounded to nearest 100.

These magnet ingestion estimates are lowest during the middle 3 years (2014-2016). Table 5 compares these middle 3 years against the earliest and most recent 4-year periods (2010-2013 and 2017-2020, respectively). Given these periods are not all of equivalent duration, annual averages are estimated, to support fair comparisons.

Table 5: Estimated Number of In-Scope Magnet-Related Ingestions Treated in Hospital Emergency Departments by Period

Period	Annual Average Estimate	CV	N (not an average)	Years in Period
2010 - 2013	2,300	0.16	395	4
2014 - 2016	1,300	0.20	200	3
2017 - 2020	2,300	0.15	419	4
2010 - 2020	2,000	0.14	1,014	11

Source: NEISS, CPSC; estimates rounded to nearest 100.

In the following tables, estimates are shown for the entire 11-year timeframe 2010 through 2020.⁵⁵ **Table 6** presents the breakdown by age group.

Table 6: Estimated Number of In-Scope Magnet-Related Ingestions Treated in Hospital Emergency Departments by Age Group, 2010—2020

Age Group	Estimate	CV	N
Under 2 years	2,700	0.19	120
2 years	2,300	0.27	89
3-4 years	4,700	0.16	196
5-7 years	4,300	0.14	207
8-10 years	3,900	0.19	179
11-13 years	3,400	0.17	182
14 or More years	**	**	41
Total	22,500	0.14	1,014

**This estimate does not meet NEISS reporting criteria.

Source: NEISS, CPSC; estimates are rounded to nearest 100.

The estimated number of these magnet-related, emergency department-treated ingestions by sex, is provided in **Table 7**.

Table 7: Estimated Number of In-Scope Magnet-Related Ingestions Treated in Hospital Emergency Departments by Sex, 2010—2020

Sex	Estimate	CV	N
Female	9,100	0.15	421
Male	13,300	0.14	593
Total	22,500	0.14	1,014

Source: NEISS, CPSC; estimates are rounded to nearest 100. Estimates do not always add to Total due to rounding.

Table 8 cross tabulates sex against whether the victim is under the age of 8 or older. Victims' ages are split between younger than 8 years and 8 years or older, because, as discussed in Tab C, various standards organizations include allowances for hazardous magnets in certain children's toys intended for ages 8 years and older, if the products include specified warnings.

⁵⁵ Collapsing all 11 years together allows some estimates to be reported that may not be fully reportable over shorter periods (e.g., annual, tri-annual, or otherwise). This is the case, for example, for various estimates by age group.

Table 8: Estimated Number of In-Scope Magnet-Related Ingestions Treated in Hospital Emergency Departments by Sex and Age Group, 2010—2020

Sex	Age Group		Total
	Under 8 Years	8 or More Years	
Female	5,600	3,500	9,100
Male	8,400	4,900	13,300
Total	14,000	8,500	22,500

NEISS, CPSC; estimates are rounded to nearest 100. Estimates do not always add to Total due to rounding.

An estimated 4,200 (19% of 22,500) are hospitalized or transferred to another hospital, and an estimated 18,000 (80%) are treated and released, as shown in **Table 9**. Discussed in Tab C, some portion of cases resulting in victims “treated and released” may have resulted in further hospitalization, because victims complaining of magnet ingestions are often sent home initially to monitor for natural passage, and the NEISS data typically capture only one part of the treatment process (the emergency department visit), and do not show information on treatment after the initial visit.

Table 9: Estimated Number of In-Scope Magnet-Related Ingestions Treated in Hospital Emergency Departments by Disposition, 2010—2020

Disposition	Estimate	CV	N
Hospitalized/Transferred	4,200	0.19	264
Treated and Released	18,000	0.14	735
Other *	**	**	15
Total	22,500	0.14	1,014

*Dispositions observed among the “other” category in the sample cases include “Held for observation (includes admitted for observation)” and “Left without being seen/Left against medical advice.”

**This estimate does not meet reporting criteria.

Source: NEISS, CPSC; estimates are rounded to nearest 100.

*CPSRMS Reported Incidents Analysis*⁵⁶

In total, staff found reports for 284 CPSRMS-reported magnet ingestion incidents. Staff grouped these incidents similarly to the NEISS-reported cases. However, there are slight changes to the criteria given that CPSRMS reports typically contain more product-specific information than the NEISS reports. This is likely because NEISS reports are provided by hospitals, where the medical provider’s focus is on treatment, rather than product-specific information. In contrast, CPSRMS reports commonly come from manufacturers or consumers, who are better able to identify the product and provide information about it. CPSRMS reports may provide photos and

⁵⁶CPSC staff considers CPSRMS reports to be anecdotal, because, unlike NEISS data, they cannot be used to identify statistical estimates or year-to-year trend analysis, and because incident reports CPSC receives in CPSRMS can range in hazard severity, including incidents with only the potential to cause injury. Although these anecdotal data do not provide for statistical analyses, they often provide rich data with important information to identify hazard patterns, as well as provide a minimum count of certain injuries and deaths.

websites with detailed narratives and medical documents. On the other hand, NEISS reports contain only brief narratives from the emergency department visit. The categories and their criteria are provided below:

- *Magnet Set*: Magnets from sets of loose-as-received ingestible magnets that are marketed or commonly used as a manipulative or construction item for entertainment, such as puzzle working, sculpture building, mental stimulation, or stress relief. These items met at least one of the following criteria:
 - referred to as a magnet set,
 - identified as a magnet set through product name,
 - included photos identifying the product, or
 - other available information providing staff reasonable certainty that the involved product was a magnet set (*e.g.*, products described identically to known magnet sets, such as desk toys consisting of 216 loose, magnetic balls).

Brand was indicated for most of these incidents. Incidents were excluded from this grouping if a medical professional identified the product as a magnet set, but the investigator and victim indicated that they were unable to identify the product as a magnet set.

- *Magnet Toy*: Magnets from products referred to as toys or games. This count includes products for which the manufacturer-intended user of the toy was an adult or unknown, and it excludes cases that positively identified toys subject to ASTM F963 (*i.e.*, excludes products confirmed to have been designed, manufactured, or marketed as playthings for children under 14 years of age).
- *Jewelry*: Magnets described as jewelry and not definitively identified as a magnet set. Most of these cases involve magnets described as a bracelet, necklace, or piercing jewelry.
- *Science Kit*: Magnets from products identified as a science kit or magnetic/electrical experimental set.⁵⁷
- *Home/Kitchen*: Magnets from products such as non-toy magnet decorations, shower curtains, hardware, and kitchen products.
- *F963 Magnet Toy*: Magnets from toys subject to ASTM F963 (*i.e.*, products designed, manufactured, or marketed as playthings for children under 14 years of age). Reports for these incidents included brand names or other information sufficient for staff to identify the products involved as toys subject to ASTM F963. The majority of these cases involved magnetic building sets with magnets encased in plastic.
- *Unidentified*: Magnets from unidentified products, although product characteristics and use patterns typically shared commonalities with subject magnet products.

Consistent with the NEISS data analysis, staff further sorted incidents, as follows:

- “Amusement/Jewelry” – Incidents involving “magnet sets,” “magnet toys,” or “jewelry”;
- “Unidentified” – Incidents involving “unidentified” magnet products;
- “Exclusions” – Incidents involving “home/kitchen” products, “F963 magnet toys,” or “science kits.”

⁵⁷ No reported incidents were found to satisfy this category.

As with the NEISS-reported data, many of the cases in these groupings include a degree of uncertainty in product identification (such as a “magnet toy” actually involving a “magnet set”), and staff finds it likely that a substantial proportion of the magnet ingestion incidents in which there was insufficient information to identify the product, involved subject magnet products. Regarding the “exclusions,” none of the incident reports identified or described science kits or other products presumably used for education and research only.

Table 10 breaks down the number of reported magnet-related ingestions in each category. The plurality of reported incidents is in the *Magnet Set* category (47.2%), as compared to other categories: “*Magnet toy*” (17.3%), “*Jewelry*” (10.9%), and *Unidentified* (15.1%), which likely involve the subject products. Fewer cases involved products in the known out-of-scope categories: “*Science Kit*” (0%), “*F963 Magnet Toy*” (7.4%) and “*Home/Kitchen*” (2.1%).

Table 10: Magnet Category and Scope for Reported Magnet-Ingestions, January 2010—December 2020*

Magnet Category	Incidents	Proportion	Scope	Incidents	Proportion
Magnet Set	134	47.2%	Amusement/ Jewelry	214	75.4%
Magnet toy	49	17.3%			
Jewelry	31	10.9%			
Unidentified	43	15.1%	Unidentified	43	15.1%
Science Kit	0	0%	Exclusions	27	9.5%
F963 Magnet Toy	21	7.4%			
Home/Kitchen	6	2.1%			
Total	284	100.0%	Total	284	100.0%

*

CPSRMS reporting for the years 2019-2020 is ongoing.

Figure 1 shows the year of incident by magnet category. The first four categories (which include products either in-scope or likely in-scope) are graphed separately above a graph of the latter two categories (all determined *out* of the scope of this draft rulemaking). In part because reporting to the CPSRMS databases may be influenced by media reports and because reporting for any year is never “closed,” this anecdotal reporting cannot be used to draw conclusions about trends in the number of cases occurring, but represents the number of reports that CPSC has received, to date.⁵⁸ Reporting is not complete, especially for the years 2019-2020. Therefore, counts for reported incidents in those years may increase as CPSC continues to collect data. In addition, some incidents may never be reported, and staff cannot determine how the frequency of unreported incidents may vary from year to year. The data reflect what has been reported to CPSC and are not a reflection of *all* incidents that have actually occurred. They do, however, provide at least a minimum number for magnet-ingestion incidents during the timeframe covered.

⁵⁸ For trend information, see the *NEISS Estimates* section of this memorandum.

Figure 1: Histogram by Incident Year and Magnet Category for Reported Magnet-Ingestions, January 2010—December 2020*

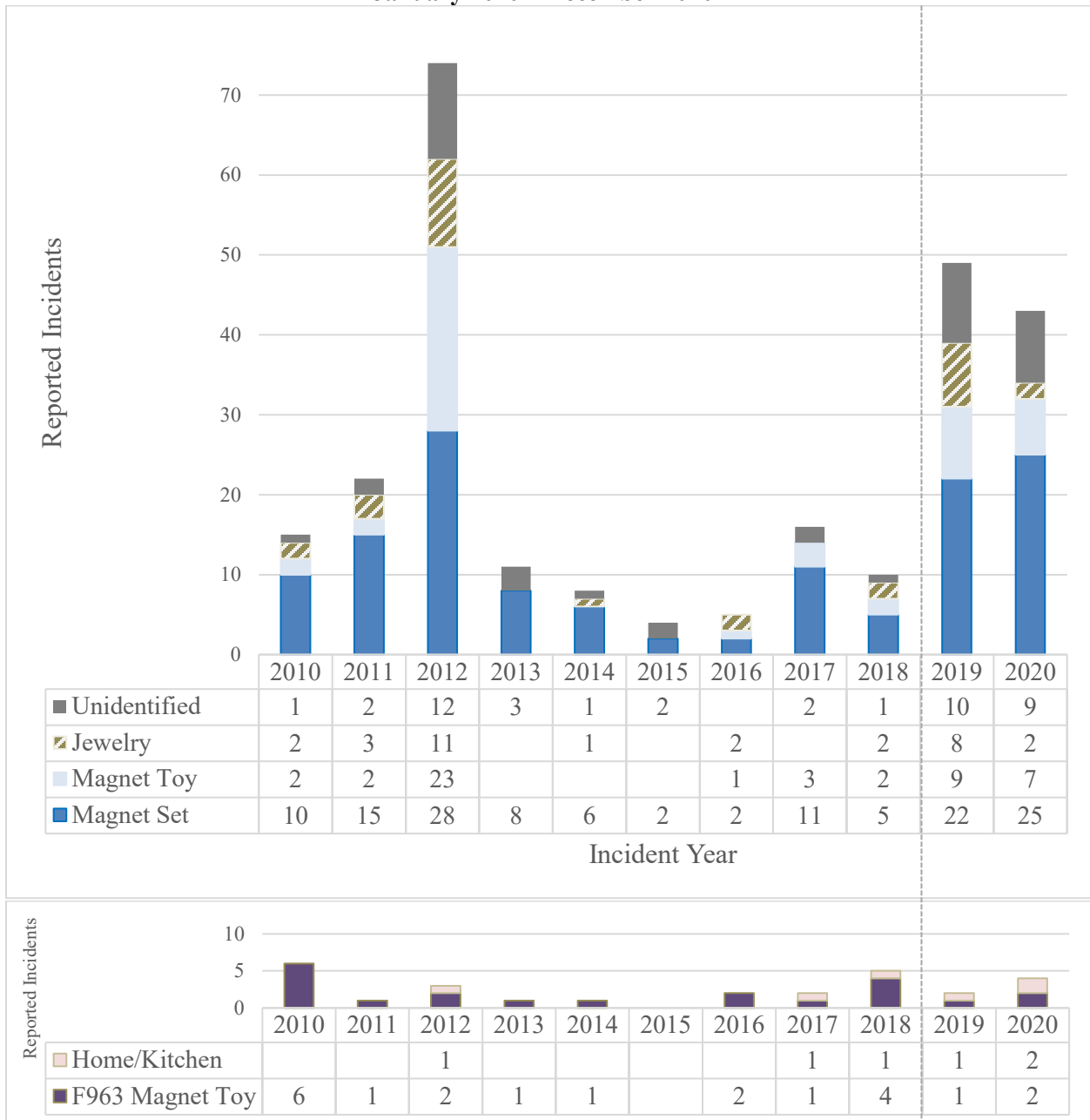

*CPSRMS reporting for the years 2019-2020 is ongoing, and counts for those years may increase as reporting continues.

Figure 2 is a histogram showing reported magnet ingestions by age of individuals, within each magnet category (with known out of scope products in a separate graph below). The overall observed distribution is bimodal (e.g., two frequently indicated ages), with one mode at 2 years of age and the other mode at 9 years of age.

Figure 2: Histogram by Victim Age* and Magnet Category for Reported Magnet-Ingestions, January 2010—December 2020**

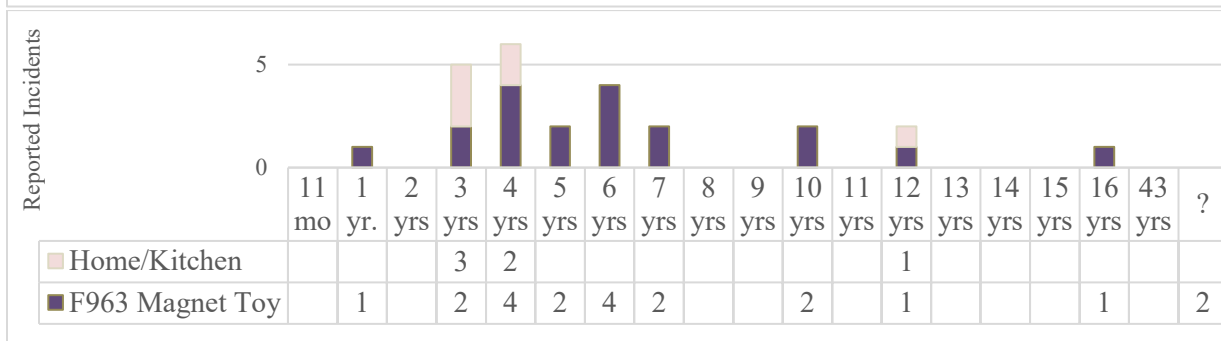
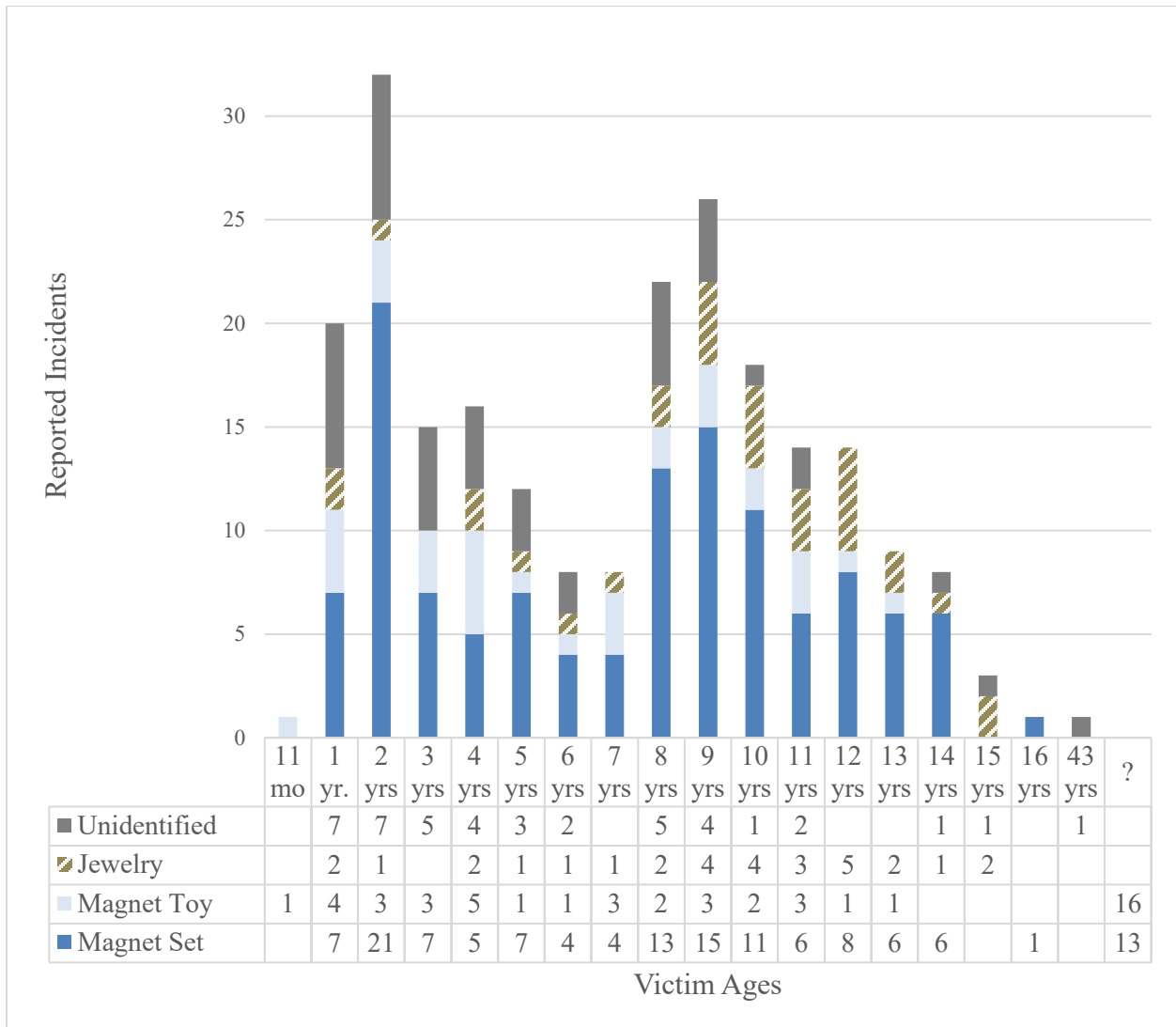

* Incidents of unknown victim age are not graphed but counted under “?” in the final age column. One child is counted as age 15 years, based on the assessment of the conflicting information reported; although it could not be ruled out the child may have been age 16 years instead.

**CPSRMS reporting for the years 2019-2020 is ongoing.

Table 11 provides the number of reported incidents by disposition of the incident (*e.g.*, severity of outcome) and magnet category. Of the 284 reported ingestions, 187 (65.8%) resulted in hospitalization, and 3 (1.1%) resulted in death.

Table 11: Disposition by Magnet Category for Reported Magnet-Ingestions, January 2010—December 2020*

Magnet Category	Disposition			Total
	Death	Hospitalization	Other	
Magnet Set	-	88	46	134
Magnet toy	-	36	13	49
Jewelry	-	21	10	31
Unidentified	3	27	13	43
F963 toy	-	10	11	21
Home/Kitchen	-	5	1	6
Total	3	187	94	284

*CPSRMS reporting for the years 2019-2020 is ongoing. “Other” includes all remaining incidents reported *without indicating* hospitalization or death.

III. References

Garland, S. (2012). Memorandum, Subject: *NEISS estimates and analysis of reported incidents related to ingestion of small, strong magnets that are part of a set of magnets of various sizes*. Bethesda, MD: Division of Hazard Analysis, Directorate for Epidemiology, U.S. Consumer Product Safety Commission.

Garland, S. (2014). Memorandum, Subject: *Update to NEISS estimates and reported incidents related to ingestion of magnets from high-powered magnet sets*. Bethesda, MD: Division of Hazard Analysis, Directorate for Epidemiology, U.S. Consumer Product Safety Commission.

Schroeder, T. *Trend Analysis of NEISS Data*. February 2000. U.S. Consumer Product Safety Commission.

Schroeder, T. and Ault, K. (2001b). https://www.cpsc.gov/s3fs-public/pdfs/blk_media_2001d011-6b6.pdf. June 2001. U.S. Consumer Product Safety Commission.

TAB C: Human Factors Assessment of Hazardous Magnet Products



UNITED STATES
CONSUMER PRODUCT SAFETY COMMISSION
BETHESDA, MARYLAND 20814

Memorandum

Date: September 12, 2021

TO: The Hazardous Magnet Products Rulemaking Project File

THROUGH: Mark Kumagai, Associate Executive Director,
Directorate for Engineering Sciences

Rana Balci-Sinha, Director
Division of Human Factors,
Directorate for Engineering Sciences

FROM: Stephen Harsanyi, Engineering Psychologist
Division of Human Factors,
Directorate for Engineering Sciences

SUBJECT: Human Factors Assessment of Hazardous Magnet Products

I. Introduction

Staff of the U.S. Consumer Product Safety Commission (CPSC) recommends addressing through rulemaking the internal interaction hazard associated with the ingestion of small, powerful magnets (“hazardous magnets”) by children and teens. Hazardous magnets are small enough to fit entirely within the small parts cylinder,⁵⁹ and also strong enough to interact through body tissue, posing risks of death and acute- and long-term adverse health consequences from volvulus injuries, fistulae, and perforations. Detailed below, the internal interaction hazard posed by hazardous magnets in consumer products has been well-documented for over a decade by CPSC, foreign regulators, medical associations, and various consumer advocacy groups. Staff estimates 23,700 emergency department-treated ingestions of magnets from January 1, 2010 through December 31, 2020. Magnet ingestions have risen considerably in recent years and typically involve children and teens ages 16 years and younger.

Staff recommends addressing magnet ingestion-related injuries involving consumer products by mandating performance requirements for consumer products that include one or more magnets that are loose or separable, and designed, marketed, or intended to be used by consumers for entertainment, jewelry (including children’s jewelry), mental stimulation, stress relief, or a

⁵⁹ The small parts cylinder referenced in the draft proposed rule is specified in 16 CFR part 1501—Method for Identifying Toys and Other Articles Intended for Use by Children Under 3 Years of Age Which Present Choking, Aspiration, or Ingestion Hazards Because of Small Parts.

combination of these purposes (“subject magnet products”). The subject magnet products do not include “children’s toys” subject to the requirements in ASTM F963, *Standard Consumer Safety Specification for Toy Safety*, which is mandated by 16 CFR part 1250,⁶⁰ or magnet products intended for education and research and/or home and kitchen (such as shower curtains and magnetic closures) purposes, which do not also fit the criteria of the subject magnet products; for example, a magnet product intended only for education and research at a university, and not intended for amusement or jewelry, would be excluded from the scope of the draft proposed rule. The draft proposed rule extends the magnet size and strength requirements established by ASTM F963 to the subject magnet products; specifically, under the draft proposed rule, any loose or separable magnets in the subject magnet products must meet the following criteria: (1) each magnet must be too large to fit entirely within the small parts cylinder described in 16 CFR 1501.4; or (2) each magnet must have a flux index of less than 50 kG² mm², as measured by the procedures for determining the magnetic attractive force described in ASTM F963.⁶¹

In this memorandum, staff provides the following information: (1) analysis of hazard patterns, (2) discussion of existing standards and the effectiveness of safety messaging and packaging requirements for the subject magnet products, (3) review of prohibitions in other countries pertaining to hazardous magnets in consumer products, and (4) explanation of staff’s recommended requirements for addressing the internal interaction hazard.

II. Discussion

Magnet ingestion incidents have been on the rise since the previous rule on magnet sets (79 FR 59962)⁶² was vacated in 2016. Staff’s estimates of emergency department-treated magnet ingestions (Tab B; Topping, 2021) show a strong relationship between magnet ingestions and the previous rule on magnet sets, demonstrating cases falling appreciably in the full years of the announcement (October 2014), publication (April 2015), and removal of the rule (November 2016), before rising again appreciably the years following the year it was removed. Staff had similar findings with non-statistical (*i.e.*, anecdotal) data from CPSC’s Consumer Product Safety Risk Management System (CPSRMS): of the CPSRMS-reported magnet ingestions from 2010 through 2020 (excluding known out-of-scope incidents), 47.5 percent of the ingestions occurred prior to the year the rule was announced (2010 – 2013), only about 6.6 percent of the ingestions occurred in the full-year period from rule announcement to rule removal (2014 – 2016), and about 45.9 percent of the ingestions occurred in the years since the removal (2017 – 2020). Detailed in the briefing memorandum, other researchers had similar findings regarding the NEISS data and magnet exposure call data from the National Poison Data System (NPDS). These trends, although correlational, support the findings from staff and other researchers that the announcement and publication of the 2014 rule on magnet sets likely caused a substantial reduction in magnet ingestions, and that incidents are rising substantially again because the rule was removed.⁶³

⁶⁰ ASTM F963 – 17 defines a “toy” as “any object designed, manufactured, or marketed as a plaything for children under 14 years of age.”

⁶¹ The flux index (magnetic force) of a magnet is calculated by multiplying the square of the magnet’s surface flux density (in KGauss) by its maximum cross-sectional area (in mm²).

⁶² See Briefing Package: Final Rule on Safety Standard for Magnet Sets (2014): https://cpsc.gov/s3fs-public/pdfs/foia_SafetyStandardforMagnetSets-FinalRule.pdf.

⁶³ Such findings are correlational, and therefore subject to extraneous variables that may have instead caused or contributed to this relationship.

Magnet ingestion incidents have usually involved children and teens ages 16 years and younger ingesting magnets while playing with the magnets or using them as jewelry. If ingested, some magnets, as a consequence of their properties, are powerful enough to interact internally with one another, or with ferromagnetic objects (materials that attract to magnets), through body tissue, and resist natural bodily forces to separate the magnets. This interaction has led to deaths and serious injuries, typically by causing intestinal twisting (volvulus injuries), fistulae, and perforations.

In total, CPSC is aware of seven deaths involving the ingestion of hazardous magnets between November 24, 2005 and January 5, 2021. Five of these deaths occurred in the United States. In 2005, a 20-month-old child's death involved ingestion of magnets from a children's toy building set with plastic-encased magnets; the product was later recalled.⁶⁴ In 2013, a 19-month-old child's death involved multi-colored, 5 mm diameter spherical magnets from an unidentified product. In 2018, a 2-year-old child's death involved multi-colored, 3-5 mm (estimated) diameter spherical magnets with indications that the product likely was a magnet set (*i.e.*, described as a magnet fidget toy building set). In 2020, a 43-year-old adult's death involved unknown magnets. In 2021, a 15-month-old-child's death involved a magnet set of an unknown brand. In addition, CPSC is aware of two deaths in other countries that involved ingestion of hazardous, 5 mm diameter, spherical NIB magnets. In Australia in 2011, an 18-month-old child's death involved a product that included indications that it may have been a magnet set; and in Poland in 2014, an 8-year-old child's death involved a product that appeared likely to be a magnet set. While only one of these seven incidents identifies explicitly that a magnet set was involved, most of these incidents identify products consistent with magnet sets, and staff finds it plausible that they would be subject to the draft proposed rule.

Staff recommends addressing this hazard through performance requirements that effectively reduce the likelihood of children and teens ingesting hazardous magnets.

A. Subject Magnet Products

The subject magnet products are products with one or more magnets, which are loose or separable, and designed, marketed, or intended to be used by consumers for entertainment, jewelry (including children's jewelry), mental stimulation, stress relief, or a combination of these purposes (purposes abbreviated below as "amusement or jewelry"). Examples of the subject magnet products include magnet sets intended for adults (users 14 years and older),⁶⁵ other types of magnet toys marketed to adults (such as other products commonly referred to as "executive toys" and "adult desk toys"), and jewelry with separable magnets (such as jewelry making sets and faux magnetic piercings/studs). Jewelry with non-removable magnets, such as a necklace with a magnetic clasp, would not be considered a subject magnet product. Although most

⁶⁴ The children's toy associated with the death of the 20-month-old child in 2005 was recalled in 2006. See press release #06-127: <https://www.cpsc.gov/Recalls/2006/childs-death-prompts-replacement-program-of-magnetic-building-sets>.

⁶⁵ Although CPSC generally considers "adults" to be age 18 years and older, in this package, "adults" is used to refer to products intended for consumers ages 14 years and older, because these products are not subject to the existing regulation for children's toys (ASTM F963 mandated by 16 CFR part 1250).

subject magnet products are intended for users 14 years or older, some subject magnet products, such as children’s jewelry, would be considered “children’s products.”⁶⁶ Figure 1 below shows images of some products considered in-scope of the draft proposed rule.



Figure 1. Examples of a magnet set executive desk toy (left), a decompression magnet pen toy (middle-left), rock magnet fidget toy (middle-right), and a magnetic jewelry set (right).

The subject magnet products do not include the following types of products:

- home and kitchen products, such as shower curtains and hardware, unless they meet the criteria for the subject magnet products;
- magnet products intended only for education and research, such as science kits for schools and universities; and
- children’s toys subject to ASTM F963.

Staff analyzed the incident data, behavioral patterns, and ability to access and use the products, and considered available literature, international actions, and stakeholder contributions through the voluntary standards process. Staff determined that the magnet products that are within scope of the draft proposed rule carry the highest risk for children and teens in terms of ingestion-related outcomes. Staff is particularly concerned about magnet sets, because their involvement in ingestion injuries is well-documented, including in previous CPSC staff packages, such as the 2014 rule on magnet sets (79 FR 59962) and the 2020 informational briefing package regarding magnet sets. Consistent with the 2014 rule, “magnet sets” are aggregations of separable magnetic objects that are marketed or commonly used as manipulative or construction items for entertainment, such as puzzle working, sculpture building, mental stimulation, or stress relief. Magnet sets often contain hundreds to thousands of loose, hazardous magnets. Numerous countries have regulations specific to magnet sets because they acknowledge the serious risk of injury associated with these products. Some countries, such as Australia, include in their hazardous magnet prohibitions other magnet products, similar to those specified in the draft proposed rule, addressing the hazard patterns, such as ingestion while playing with magnets and using magnets as jewelry, and acting preemptively rather than reactionary regarding products not currently on the market or identified with certainty in the data, which pose the hazard.

⁶⁶ The Consumer Product Safety Act defines “children’s products” as products designed or intended primarily for children 12 years or younger. 15 U.S.C. 2052(a)(2). The designation of a product as a children’s product is based on manufacturer statements about intended use (including labeling); whether the product is packaged, displayed, promoted, or advertised as appropriate for 12 and younger; whether it is commonly recognized by consumers as being intended for 12 and under; and the CPSC Age Determination Guidelines. Guidelines can be accessed via https://www.cpsc.gov/s3fs-public/pdfs/blk_media_adg.pdf.

The subject magnet products are not limited by magnet composition. Staff has found that various magnet compositions have been involved in internal interaction incidents, such as Neodymium-Iron-Boron (NIB), typically found in the smaller magnets used in magnet sets and magnetic jewelry sets, and ferrite/hematite, as typically found in larger magnets, such as rock-shaped magnet toys (Figure 1). Discussed in Tab D (Paul, 2021), staff found that 5 mm diameter NIB magnets, which are the most common size identified in magnet ingestion incidents, typically measured between 300 and 400 kG² mm², and ferrite rock magnets measured upwards of 700 kG² mm². Magnets involved in incidents include a variety of shapes, such as spheres, cubes, rods, and rocks, among others. It is important to note that most incident reports lack specific information pertaining to the shape, size, and composition of magnets involved in ingestion incidents, which is why strength and size requirements are necessary to limit the capability of magnets from the subject magnet products to be ingested and result in internal interaction injuries.

B. Analysis of Hazard Patterns

Discussed in Tab B, an estimated 23,700 magnet-related ingestions were treated in hospital emergency departments from January 1, 2010 through December 31, 2020, based on the 1,072 magnet ingestion reports extracted from the National Electronic Injury Surveillance System (NEISS) on January 8, 2021. Of these 23,700 ingestions, staff estimates that 1,300 ingestions involved products that are not subject to the draft proposed rule (*i.e.*, education/research products and home/kitchen products not intended for amusement or jewelry, and children's toys subject to ASTM F963). Excluding these out-of-scope cases, staff estimates 22,500 ingestions occurred from 2010 through 2020, including ingestions involving magnets for which the subject products could not be ruled out on a case-by-case basis. Excluding known out-of-scope cases, staff estimates that 18,000 ingestions resulted in victims being treated and released, and an estimated 4,200 ingestions resulted in victims being immediately hospitalized or transferred. Patients presenting to emergency departments and other hospitals for foreign body ingestion of magnets are often sent home initially after primary diagnostic procedures (such as x-rays) to monitor for natural passage of the magnets. The NEISS reports capture one part of the treatment process (the emergency department visit), and typically do not show information on treatment after the initial visit. Therefore, the number of victims ultimately hospitalized may be significantly higher than captured in the above estimates.

Of the 22,500 magnet ingestions excluding known out-of-scope cases, an estimated 4,400 ingestions involved products identified or described for amusement and/or jewelry purposes, and an estimated 18,100 ingestions involved unidentified magnet products. Based on the magnet-related incident trends relative to the 2014 rule on magnet sets, and additional reasons discussed below, staff finds it likely that a substantial proportion of the magnet ingestion incidents in which there was insufficient information to identify the product, involved subject magnet products.

Staff also analyzed CPSRMS-reported incident data. The CPSRMS data cover incident reports from consumers, doctors, retailers, manufacturers, and other sources. Staff examined CPSRMS reports for 284 magnet ingestion incidents that occurred from January 1, 2010 through December 31, 2020. The reported incidents in the CPSRMS database do not provide a complete count of

all incidents that occurred during the period of interest and cannot be used for statistical estimates. However, they do provide a minimum number for the incidents occurring during this period, and the reports generally provide more information about the incidents, involved products, and victims than reported in the NEISS data. Through the CPSRMS data, staff is aware that at least 124 incidents resulted in some form of surgery (including laparoscopy, laparotomy, appendectomy, cecostomy, enterotomy, colostomy, cecectomy, gastrotomy, jejunostomy, resection, and transplant). Numerous other incidents resulted in procedures less invasive than surgery, such as endoscopies and colonoscopies, and may have eventually resulted in surgery had the magnets or some of the magnets not been retrieved in a timely manner (*e.g.*, some reports describe doctors managing to non-surgically retrieve one of two groups of separated magnets before they could interact with one another). At least 108 incidents involved internal interaction through body tissue. Detailed in Tab A, common medical interventions for magnet ingestion may present risks of injury, such as bleeding and infection from tears during endoscopy and surgery, and adverse cardiopulmonary events as a result of sedation and anesthesia. Regardless of injury in the specific incidents, the magnet ingestion incidents demonstrate common hazard patterns that remain prevalent.

Among other pertinent factors, staff considered in the data: magnet product category, victims' ages, victim and caregiver behavioral patterns, and sources of access to the magnets. Unless otherwise specified, references to NEISS data below are based on the number of cases examined by staff (1,072 NEISS cases), and do *not* take estimates into consideration. For NEISS estimates, as discussed in Tab A, considerations are made to numerous variables, including the data sources and relative weights of the data, such as the number of participating children's hospitals.

Magnet Product Categories

Based on the identification and/or description of the products involved in the incidents, staff organized the incidents into the following magnet categories: "magnet set," "magnet toy," "jewelry," "science kit," "home/kitchen," "F963 magnet toy," and "unidentified." Tables 1 and 2, below, provide the descriptions of these magnet categories, and criteria staff used to categorize incidents into them. The descriptions vary a small amount between these tables because the CPSRMS reports typically contain more product-specific information than the NEISS reports; for example, CPSRMS reports may provide photos, websites, detailed narratives, and medical documents, whereas NEISS reports contain only brief narratives culled from medical records developed during the emergency department visit.

Table 1. Magnet categories in the 1,072 NEISS-reported magnet ingestions. The percentages in this table are rounded to the nearest tenth.

Magnet Category	Count	Percentage of Magnet Ingestions	Description
Magnet Set	58	5.4%	Magnets from sets of loose-as-received ingestible magnets that are marketed or commonly used as a manipulative or construction item for entertainment, such as puzzle working, sculpture building, mental stimulation, or stress relief. Referred to as a magnet set or identified as a magnet set through product name. Excludes: <ul style="list-style-type: none"> • Building sets with plastic and/or ferromagnetic components, unless otherwise identified as a magnet set. • Products reasonably identified as belonging to the other product types such as a magnetic clasp from a necklace.
Magnet Toy	110	10.3%	Magnets from products referred to as toys or games. This count includes products for which the manufacturer-intended user of the toy was an adult or unknown age, and it excludes cases that positively identified toys subject to ASTM F963 (<i>i.e.</i> , excludes products confirmed to have been designed, manufactured, or marketed as playthings for children under 14 years of age).
Jewelry	53	4.9%	Magnets described as jewelry and not definitively identified as a magnet set. Most of these cases involve magnets described as a bracelet, necklace, or piercing jewelry.
Science Kit	1	0.1%	Magnets from products identified as a science kit or magnetic/electrical experimental set.
Home/Kitchen	46	4.3%	Magnets from products such as non-toy magnet decorations, shower curtains, hardware, and kitchen products. Many of these cases specifically refer to the magnets as “kitchen magnets.”
F963 Magnet Toy	11	1%	Magnets from toys subject to ASTM F963 (<i>i.e.</i> , products designed, manufactured, or marketed as playthings for children under 14 years of age). Reports for these cases included brand names or other information sufficient for staff to identify the involved products as toys subject to ASTM F963. The majority of these cases involved the magnetic tip of a children’s magnetic stylus toy.
Unidentified	793	74%	Magnets from unidentified products, although product characteristics and use patterns typically shared commonalities with subject magnet products.
Total	1,072		

Table 2. Magnet categories in the 284 CPSRMS-reported magnet ingestions. The percentages in this table are rounded to the nearest tenth.

Magnet Category	Count	Percentage of Magnet Ingestions	Description
Magnet Set	134	47.2%	<p>Magnets from sets of loose-as-received ingestible magnets that are marketed or commonly used as a manipulative or construction item for entertainment, such as puzzle working, sculpture building, mental stimulation, or stress relief. These items met at least one of the following criteria:</p> <ul style="list-style-type: none"> referred to as a magnet set, identified as a magnet set through product name, included photos identifying the product, or other information provided to claim with reasonable certainty that the involved product was a magnet set (<i>e.g.</i>, products described identically to known magnet sets, such as desk toys consisting of 216 loose, magnetic balls). <p>Brand was indicated for most of these incidents. Incidents were excluded from this grouping if a medical professional identified the product as a magnet set, but the investigator and victim indicated that they were unable to identify the product as a magnet set.</p>
Magnet Toy	49	17.3%	<p>Magnets from products referred to as toys or games. This count includes products for which the manufacturer-intended user of the toy was an adult or unknown, and it excludes incidents that positively identified toys subject to ASTM F963 (<i>i.e.</i>, excludes products confirmed to have been designed, manufactured, or marketed as playthings for children under 14 years of age).</p>
Jewelry	31	10.9%	<p>Magnets described as jewelry and not definitively identified as a magnet set. Most of these incidents involve magnets described as a bracelet, necklace, or piercing jewelry.</p>
Science Kit	0	0%	<p>Magnets from products identified as a science kit or magnetic/electrical experimental set.</p>
Home/Kitchen	6	2.1%	<p>Magnets from products such as non-toy magnet decorations, shower curtains, hardware, and kitchen products.</p>
F963 Magnet Toy	21	7.4%	<p>Magnets from toys subject to ASTM F963 (<i>i.e.</i>, products designed, manufactured, or marketed as playthings for children under 14 years of age). Reports for these incidents included brand names or other information sufficient for staff to identify the involved products as toys subject to ASTM F963. The majority of these incidents involved magnetic building sets with magnets encased in plastic.</p>
Unidentified	43	15.1%	<p>Magnets from unidentified products, although product characteristics and use patterns typically shared commonalities with subject magnet products.</p>
Total	284		

Staff combined these magnet categories as follows:

- “Amusement/Jewelry” – ingestions of magnets from “magnet sets,” “magnet toys,” or “jewelry” (221 NEISS ingestions and 214 CPSRMS ingestions);
- “Unidentified” – ingestions of magnets from “unidentified” magnet products (793 NEISS ingestions and 43 CPSRMS ingestions);
- “Exclusions” – ingestions of magnets from “science kits,” “home/kitchen” products, or

“F963 magnet toys” (58 NEISS ingestions and 27 CPSRMS ingestions).

Staff found that, in most cases, product identification was uncertain, and therefore, staff considered both positive identification, such as brand name, and product description. For example, many of the “jewelry” ingestions involved magnets described as bracelets, necklaces, and faux piercings/studs, but some portion of these ingestions may have involved magnet sets or other products. Similarly, products were categorized as “magnet toys” based on positive identification and/or description as “toys,” “games,” or similar. Staff attempted to separate from this category products identified as children’s toys subject to ASTM F963 (out-of-scope of the draft proposed rule). As a consequence of uncertainties, some portion of the “magnet toy” ingestions may involve magnet sets or other products. Of the products with positive identification, magnet sets were the most common in each data set. Staff found that ingestions categorized as “amusement/jewelry,” were more common than the “exclusions,” and more likely to have involved surgery and internal interaction through tissue.

Regarding the “exclusions,” staff considered the single ingestion involving a product referred to as a “science kit” to be out-of-scope because staff finds it plausible that the product was intended for education/research, or may have been a children’s toy subject to ASTM F963.⁶⁷ “Home/kitchen” products include important utilities beyond amusement and jewelry, and were rarely involved in ingestions that resulted in surgical intervention. Many of the “home/kitchen” ingestions involved a single shower curtain magnet of unknown strength. Products identified as “F963 magnet toys” were also rarely involved in ingestions resulting in surgical intervention. Most, if not all, of these “F963 magnet toys” that resulted in surgical intervention were products with magnets encased in plastic, and these products did not meet the requirements of ASTM F963 (such as recalled toy magnetic tile building sets).⁶⁸

Based on staff’s analysis of the data (discussed further below), and the trends in magnet-related incidents relative to the 2014 rule on magnet sets, staff finds it reasonable to conclude that the magnet products with uncertain identification most likely involved magnets considered within scope of the draft proposed rule; that is, intended for amusement and/or jewelry. The “unidentified” magnet products typically had characteristics (such as “small ball”) and use patterns consistent with the subject magnet products. In the sections that follow, unless otherwise specified, the counts and percentages exclude the incidents categorized by staff as out-of-scope (“exclusions”).

Victims’ Ages

Tab B provides NEISS estimates for ages involved in magnet ingestion incidents. Table 3, below, shows the age distribution of victims in magnet ingestion incidents, excluding out-of-scope incidents. Victim age is a very important consideration for the magnet ingestion hazard,

⁶⁷ Discussed further below, staff searched the data for incidents involving “science kits,” to determine potential involvement in ingestion incidents of out-of-scope products subject to ASTM F963; ASTM F963 currently exempts from magnet performance requirements products identified in the standard as “magnetic/electrical experimental sets” for ages 8 years and older. These toys are sometimes referred to as “science kits,” and they contain one or more magnets intended for carrying out educational experiments involving both magnetism and electricity.

⁶⁸ Children’s toy magnetic building set recall: <https://www.cpsc.gov/Recalls/2007/magnetix-magnetic-building-set-recall-expanded-serious-injuries-continue-to-be-reported>.

both in terms of hazard patterns and measures by which to address the hazard.

Table 3. Age distribution of NEISS- and CPSRMS-reported magnet ingestion victims. These counts and percentages exclude the incidents categorized as out-of-scope. The percentages in this table are rounded to the nearest tenth.

Victim Age	NEISS (#)	NEISS (%)	CPSRMS (#)	CPSRMS (%)
< 2 yrs	120	11.8%	21	8.2%
2 yrs	89	8.8%	32	12.5%
3 yrs thru 4 yrs	196	19.3%	31	12.1%
5 yrs thru 7 yrs	207	20.4%	28	10.9%
8 yrs thru 10 yrs	179	17.7%	66	25.7%
11 yrs thru 13 yrs	182	18%	37	14.4%
14 yrs thru 16 yrs	30	3%	12	4.7%
> 16 yrs	11	1.1%	1	0.4%
Unknown	0	0%	29	11.3%
Totals:	1,014		257	

The youngest age reported was 6 months, and the oldest age reported was 54 years. The subject magnet products, or at least the loose or separable magnets from these products, have appeal to children and teens, including magnet sets known to be intended for consumers 14 years and older, and therefore not subject to the requirements specified in ASTM F963. The involvement of products not intended for children demonstrates why children’s and teen’s ingestion of magnets cannot be addressed adequately with the toy standard, alone. This universal appeal is due to various reasons. For fidgeting, stress relief, and other purposes of amusement, magnets have tactile appeal, particularly magnets that are smooth. Some magnets capture attention because they are shiny, colorful, or both. They make soft snapping/clicking sounds as one manipulates them. The magnets have properties of novelty, which arouse curiosity; incongruity, which tends to surprise and amuse; and complexity, which tends to challenge and maintain interest. Their strong magnetic properties cause them to behave in unexpected ways, with pieces suddenly snapping together and moving apart. Such behavior is likely to seem magical to younger children, and evoke a degree of awe and amusement among older children and teens.

Approximately 20.6 percent of the NEISS-reported incidents and 20.7 percent of the CPSRMS-reported incidents involved victims under 3 years of age. Typically, foreign body ingestions peak from 6 months to 3 years of age (Green, 2015); and 2-year-olds generally are quite mobile and unlikely to be under direct supervision at all times. Even when supervision is provided, magnet ingestion can be too quick for caregivers to see and intervene. Children of these ages are commonly cited in reports involving ingestion of inedible objects, given their likelihood of orally exploring their environment and their limited capability to comprehend hazards. For these and other reasons, toys with small parts must have a choking hazard warning regarding children under 3 years of age.⁶⁹

⁶⁹ 16 CFR part 1501. For more information, see the CPSC webpage on “Small Parts for Toys and Children’s Products Business Guide”: <https://www.cpsc.gov/Business--Manufacturing/Business-Education/Business-Guidance/Small-Parts-for-Toys-and-Childrens-Products/>.

Approximately 39.9 percent of the NEISS-reported incidents and 32.8 percent of the CPSRMS-reported incidents identified victims under 5 years of age. This age group is important to consider, as one safeguard evaluated by staff is child-resistant (CR) packaging consistent with the Poison Prevention Packaging Act (PPPA).⁷⁰ CR packaging that meets the requirements of the PPPA is designed or constructed to be significantly difficult for children under five years of age to open within a reasonable amount of time. Discussed below, CR packaging is unlikely to address the hazard for the majority of victims, as most incidents involve victims five years of age or older.

Approximately 60.3 percent of the NEISS-reported incidents and 43.7 percent of the CPSRMS-reported incidents identified victims under 8 years of age, and approximately 39.7 percent of NEISS-reported incidents and 45 percent of CPSRMS-reported incidents (approximately 11.3 percent of CPSRMS-reported incidents involved children of unspecified ages) identified victims 8 years of age or older. It is important to note the high percentages of victims 8 years and older, considering that various standards bodies consider these ages to be capable of understanding and following warnings pertaining to hazardous magnets. Discussed below, various standards include exemptions from performance requirements for products intended for children 8 years and older, including magnetic/electrical experimental sets and children's jewelry. Caregivers, older children, and teens are especially unlikely to anticipate and appreciate the likelihood of magnets being ingested by these ages.

Behavioral Patterns

Staff identified in the data distinct patterns in behaviors pertaining to (1) how the magnets were used at the time of ingestion, and (2) how victims and caregivers acted after the magnet ingestion event.

Staff identified the following use patterns at the time of ingestion:

- “Playing” – ingestions of magnets while playing, fidgeting, orally exploring the magnets (examples include testing the attraction through teeth or on braces), or a combination of these actions. If playing involved use of the product as jewelry, the incident was identified as “jewelry.” Excludes incidents involving intentional ingestion.
- “Jewelry” – ingestions involving magnets used as jewelry at the time of the incident, such as bracelets, necklaces, and simulated piercings (examples include magnets used around the tongue, lip, and cheek to look like real piercings).
- “Intentionally ate” – ingestions in which victims reportedly swallowed magnets on purpose (examples include curiosity and mistaking the magnets as edible).
- “Other” – ingestions involving identified actions that do not fit the above use categories (examples include transporting magnets orally, magnets thrown into a victim's mouth when not playing, and magnets placed into a victim's drink).
- “Unknown” – ingestions in which it is unclear what led to the ingestion of magnets.

⁷⁰ 16 CFR parts 1700, 1701, 1702. For more information, see the CPSC webpage on “Poison Prevention Packaging Act”: <https://www.cpsc.gov/Regulations-Laws--Standards/Statutes/Poison-Prevention-Packaging-Act/>.

Table 4. Use patterns identified in NEISS- and CPSRMS-reported magnet ingestions. These counts and percentages exclude the incidents categorized as out-of-scope. The percentages in this table are rounded to the nearest tenth.

Use Category	NEISS (#)	NEISS (%)	CPSRMS (#)	CPSRMS (%)
Playing	143	14.1%	61	23.7%
Jewelry	31	3.1%	43	16.7%
Intentionally Ate	19	1.9%	21	8.2%
Other	10	1%	4	1.6%
Unknown	811	80%	128	49.8%
Totals:	1014		257	

In each data set, of the known use categories, “playing” was the most common followed by “jewelry.” Magnets from only one incident involving a “home/kitchen” product were used as jewelry at the time of the incident, and none of the magnets from incidents involving “F963 magnet toys” were used for this purpose at the time of the incident. Many of the CPSRMS-reported incidents included important details about the victims’ use of the magnets and treatment outcomes. See Figures 2 and 3, below, for the use patterns by age in CPSRMS- and NEISS-reported incidents. Younger children, particularly those under 8 years, were more likely than older children to be involved in reports of intentional magnet ingestion (only four reports of intentional ingestion involved children 8 years and older). However, where use category was identified, the majority of the reports indicated that the magnets were ingested accidentally. Reports for these incidents tended to describe children using the magnets in or around their mouth when the magnets unexpectedly rolled to the back of their throat and were ingested, in at least some cases, by swallow reflex. Exploration is a normal aspect of child development, and children are likely to be drawn to magnets aesthetically, and due to magnets’ invisible attraction and repulsion properties.

Victims 8 years and older were more likely than younger ages to swallow magnets while simulating piercings. Use of magnets as jewelry in or around the mouth is foreseeable for this age group, for whom experimentation and peer influence are common determinants of behavior. Older children and teens often value acceptance by peers more than obeying parental guidelines, and social influences and peer pressure can drive adolescent behavior more strongly than their own independent thought processes (Tomé, et al. 2012; Knoll et al., 2017). The subject magnet products offer a seemingly, but deceptively safe and reversible way to try out lip, tongue, cheek, and nose piercings. If these children see their peers performing this activity, they may feel compelled to act similarly even if they are made aware of the risks. Furthermore, older children and early adolescents are at a developmental stage in which they test limits and bend rules (Brown & Beran, 2008; Vredenburg & Zackowitz, 2006). Staff notes that this trend of using magnets to simulate piercings is continuing. For example, a recent Newsweek article from May 2021 describes accidental ingestion of hazardous magnets by children who were mimicking tongue piercings with the magnets, and explains that online videos demonstrate this unsafe use pattern.⁷¹ It is critical to consider accidental ingestion, in part, because it has serious implications for the perceived credibility of safety messaging, particularly safety messaging

⁷¹ Newsweek article by Soo Kim, dated May 24, 2021: <https://www.msn.com/en-us/lifestyle/lifestyle-buzz/boy-fights-for-life-after-swallowing-magnetic-balls-in-deadly-tiktok-trend/ar-AAKkdj4?ocid=msedgntp>.

intended to protect children above the ages typically associated with the ingestion of inedible objects.

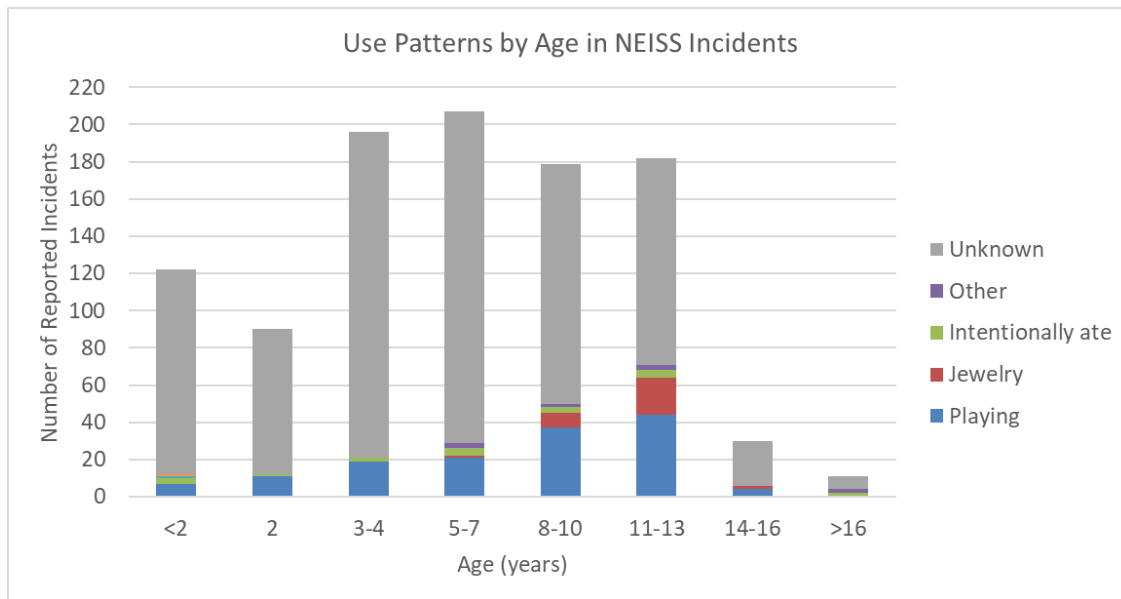

Figure 2. Use patterns by age in NEISS-reported magnet ingestions, excluding incidents categorized as out-of-scope (“exclusions”).

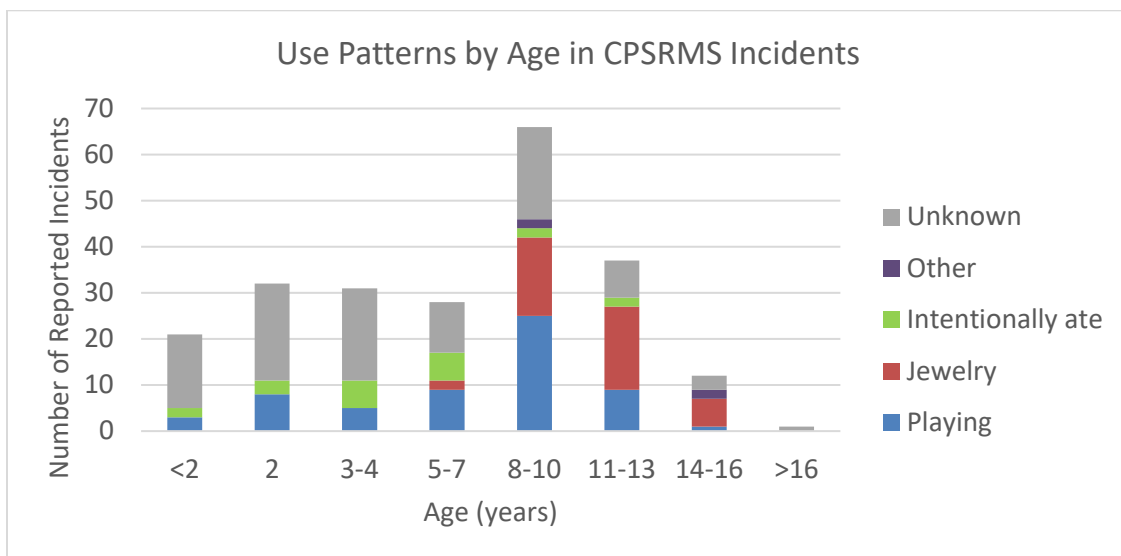

Figure 3. Use patterns by age in CPRSMS-reported magnet ingestions, excluding incidents categorized as out-of-scope (“exclusions”).

In examining use patterns, behaviors after ingestion, and severity of injuries, staff found that the invasiveness of medical interventions was often associated with the length of delay between the ingestion event and correct medical treatment. At least 56 of the CPRSMS-reported incidents (~21.8%) involved a multiday delay between ingestion and correct treatment, with some delays spanning months. At least an additional 16 incidents (~6.2%) involved a delay of one day.

Common causes of delays included: (1) caregivers being unaware of the ingestion event, resulting in delayed hospital visits and subsequent misdiagnoses, and (2) caregivers misunderstanding the hazard, such as expecting the magnets to pass naturally, which may not be the case (this depends on factors including the number of magnets ingested, whether the magnets interact through tissue, and whether the interaction is strong enough to resist natural bodily forces). In many incidents, particularly those involving children under 8 years of age, the use of the magnets at the time of ingestion was unknown. These incidents often involved ingestions that were not witnessed by the victims' caregivers, and the children were unable or unwilling to communicate what happened. One major contributor to delays is that parents and children often fail to make the connection between the magnet ingestion and the symptoms, due, in part, to the frequently seen time lapse between magnet ingestion and symptoms, and because the preliminary symptoms typically are similar to common illnesses (see Tab A). Many reports detail victims/caregivers seeking treatment only after experiencing significant discomfort, at which point substantial internal damage occurred. For example, one report indicates that in January 2017, a 3-year-old victim was found playing with her older brother's magnet set, and she told her father that she had not swallowed any magnets. Days following the incident, she became ill and was misdiagnosed with a stomach virus. Eventually, x-rays were taken, revealing three magnets in her small intestine. The victim lost a portion of her digestive tract and was hospitalized for approximately two weeks to recover after the surgery.

Sources of Access

Staff examined the reports for sources of access; meaning how and from whom the victim acquired the magnets (see Table 5). The majority of the NEISS-reported ingestions (~96.5%) did not include sufficient detail to identify the sources of access. The data below consider only the CPSRMS-reported ingestions (excluding known out-of-scope products).

Table 5. Sources of access identified in CPSRMS-reported magnet ingestions. These counts and percentages exclude the incidents categorized as out-of-scope. The percentages in this table are rounded to the nearest tenth.

Sources of Access	CPSRMS (#)	CPSRMS (%)	Description
Family Owned	59	23%	Magnets belonged to the victim's family. Includes incidents of siblings finding magnets and bringing them home.
Friend/classmate/School/neighbor	41	16%	Magnets belonged to friends, classmates, or neighbors, or found by the victim at daycares or schools.
Purchased for Victim	26	10.1%	Magnet(s) purchased for the victim.
Purchased by Victim	5	1.9%	Magnet(s) purchased by the victim.
Found Outside	4	1.6%	Victim found the magnets outside, such as on a playground. Excludes if sibling found outside and brought home.
Unknown	122	47.5%	Unclear where the magnet was acquired, by whom, or for whom; includes incidents of magnets found in home but product owner unknown.
Totals:	257		

Of the 135 incidents with a known source of access, most of them involved magnets that belonged to family members of the victims (~43.7%), followed by magnets acquired by the victims from friends, classmates, daycares, or schools (~30.4%). Approximately 19.3 percent of the incidents involved magnets purchased for the victim, and a small amount were either purchased by the victim (~3.7%) or found outside by the victim (~3%). Victims under 8 years old typically gained access to magnets that belonged to family members, such as siblings, parents, and relatives. According to reports, magnets from family members were usually found on floors, in or on furniture, in bags, and affixed to surfaces (*e.g.*, refrigerators, wallboards), and in some incidents, magnets were intentionally shared with victims by family members. In contrast, victims ages 8 years and older typically obtained magnets from friends, classmates, or schools, or the magnets were purchased for them. Most of the incidents appear to have involved children and teens acquiring loose magnets, as opposed to accessing the full set or product at the time of ingestion. Given that small, powerful magnets are too small to have legible and complete on-product warnings, and magnets involved in incidents are usually acquired absent packaging, this observation is a critical piece in the determination of whether on-package safety messaging is likely to reach the victims and caregivers. Transmission of magnets outside of the home is also concerning because caregivers cannot easily manage this source of access.

Staff searched the incident reports for information pertaining to product warnings and age labels to determine if they were present and considered by the victims and caregivers. Of the 57 incidents that mentioned if there were product warnings, about 79 percent of these incidents involved magnets with a magnet ingestion warning (*i.e.*, at least 45 incidents). Similarly, of the 60 incidents that mentioned if there were age labels, about 82 percent of these incidents involved magnets with a warning to keep the product away from children (*i.e.*, at least 49 incidents). At least 44 incidents involved products with both magnet ingestion warnings and warnings to keep the product away from children. In most incidents, there was insufficient information to determine if the involved products had warnings, age labels, or both.

Staff finds it important to consider the implications of the number of known incidents involving magnets purchased for victims and by victims, particularly those under 14 years of age. When considering only the 133 incidents with a known source of access and known victim age, about 23.3 percent of these incidents involved magnets purchased for or by victims under 14 years of age. These incidents include products, such as magnet sets, which were not marketed as playthings intended for children under 14 years old, and therefore not subject to the existing regulation (CFR part 1250). For example, there was a recent incident from late 2020 mentioned in Tab A, which involved a 10-year-old child inserting magnets from a magnet set into his nose.⁷² The victim's mother purchased the involved magnet set for the then-9-year-old victim, despite there being clear and repeated warnings about the hazard and to keep the product away from children. The victim had ADHD and had used the magnets for fidgeting until the date of the incident. He reportedly put several of the 2.5 mm diameter spherical magnets in his nose to simulate a nose ring. He was unable to remove two of the magnets, and he developed nose bleeds over the course of several weeks. He did not report the issue to his caregivers, and it was not until he had x-rays for an unrelated procedure (dental braces) that the magnets and a hole in

⁷² This case is not included in the NEISS and CPSRMS datasets discussed in this memorandum, as staff received the report after January 8, 2021, and it did not involve ingestion.

his septum were identified. Staff has examined reports for 16 other incidents involving this magnet set brand, all ingestions, and at least 10 resulting in surgery, including five with clear evidence of internal interaction through tissue.⁷³ In another recent incident (March 2021), this product was given to a 5-year-old by his caregiver, who believed the toy was harmless, and that swallowed magnets would pass naturally. The victim ended up requiring surgery, including an appendectomy, because the magnets had attracted internally through tissue. Children's and teen's ingestion of magnets cannot be adequately addressed with the toy standard, in part, because children and teens purchase, receive, and find magnets from products that are not intended for their ages.

Based on staff's technical analysis and examination of incident reports, online and on-package marketing, and consumer reviews for the subject magnet products, staff attributes these high counts of magnets made accessible to children, to the caregivers and/or victims doing one or more of the following:

- underestimating the potential severity of the hazard;
- receiving social pressures from children, other family members, and friends;
- seeing the subject magnet products or similar products marketed to children;
- seeing other children handling the subject magnet products or similar products without incident;
- reading consumer reviews about other children handling the subject magnet products or similar products without incident; or
- underestimating the likelihood that the victim would ingest a magnet, let alone multiple magnets, or a magnet and a ferromagnetic object.

C. Evaluation of Existing Standards Associated with Hazardous Magnets

Staff evaluated existing domestic standards pertaining to hazardous magnets in consumer products. These standards include one voluntary standard that has been incorporated by reference into a mandatory standard, and three voluntary standards that reference the standard adopted by the mandatory standard. In the sections that follow, staff summarizes and assesses the standards, particularly the recommendations and requirements for safety messaging and packaging, and discusses the effectiveness of safety messaging and packaging requirements for the subject magnet products. Staff provides a more detailed analysis of the performance requirements in Tab D.

Existing Domestic Standards Regarding Hazardous Magnets

Staff identified four domestic standards that address the internal interaction hazard associated with magnets in consumer products.

⁷³ Many of these cases occurred after the NEISS and CPSRMS data extraction are therefore not captured in the datasets discussed in this memorandum. These incidents include reports received up to and including August 22, 2021.

1. ASTM F963 – 17, *Standard Consumer Safety Specification for Toy Safety*

Section 106 of the Consumer Products Safety Improvement Act provides that ASTM F963 is considered a mandatory consumer product safety standard under section 9 of the Consumer Product Safety Act. Consistent with this, ASTM F963 – 17 is incorporated by reference in the mandatory standard for children’s toys (16 CFR part 1250). The standard includes performance and safety messaging requirements for objects designed, manufactured, or marketed as a plaything for children under 14 years of age. This standard identifies magnets and magnetic components as hazardous if they fit entirely within the small parts cylinder specified in the standard and have a flux index of 50 kG² mm² or higher. The standard requires that children’s toys shall not have an as-received hazardous magnet or hazardous magnetic component, nor liberate a hazardous magnet or hazardous magnetic component, per specified testing, with the exception of “magnetic/electrical experimental sets” intended for children 8 years of age and over. Magnetic/electrical experimental sets intended for children 8 years of age and over may contain hazardous magnets or hazardous magnetic components, contingent upon including in the packaging and instructions warnings that address the following text:

WARNING This product contains (a) small magnet(s). Swallowed magnets can stick together across intestines causing serious infections and death. Seek immediate medical attention if magnet(s) are swallowed or inhaled.

Per section A12.4 of ASTM F963 – 17, the intended scope of products subject to this labeling exemption are only those that combine magnetism and electricity, such as electrical motors and doorbells. There are other standards, including the European standard, EN 71-1:2014, *Safety of Toys; Part 1: Mechanical and Physical Properties*, and ISO 8124-1:2018, *Safety of Toys — Part 1: Safety Aspects Related to Mechanical and Physical Properties*, which align with ASTM F963 regarding hazardous magnets and magnetic components for toys intended for children under 14 years old, including the exemption for magnetic/electrical experimental sets. Discussed further, below, other countries, including Canada, Australia, and New Zealand align with ASTM F963 regarding hazardous magnets in toys and the identification of magnets as hazardous. Staff concludes this standard is adequate for children’s toys subject to 16 CFR part 1250; however, it is difficult to comprehensively assess the level of compliance with this standard, in part, due to the lack of product-identifying information in much of the incident data. Staff has found that relatively few of the known products involved in internal interaction incidents were toys subject to ASTM F963, which may support its effectiveness for children’s toys. Furthermore, as discussed in the briefing memorandum, CPSC’s recalls of children’s toys due to hazardous magnets peaked shortly after the standard was mandated, and have since fallen substantially, which is likely indicative of the success of the standard.⁷⁴ However, this standard, on its own, is not adequate because it applies only to toys intended for children under 14 years old, and therefore does not address the various other consumer products commonly involved in magnet ingestion incidents, which include products intended only for consumers 14 years

⁷⁴ The original requirements for toys with magnets were published in ASTM F963-07 and they were strengthened in the 2008 version. These requirements were adopted as mandatory regulations by the CPSC as mandated by the Consumer Product Safety Improvement Act of 2008 (CPSIA).

and older, such as magnet sets, jewelry, and other adult toys. It also does not address children's jewelry, which may be involved in incidents, and foreseeably presents the same risk of injury or greater than adult jewelry with loose or separable, hazardous magnets.

2. ASTM F2923 – 20, *Standard Specification for Consumer Product Safety for Children's Jewelry*

This voluntary standard for children's jewelry includes performance and safety messaging requirements for jewelry designed or intended primarily for children 12 years of age or younger. This standard refers to ASTM F963 for the identification of magnets and magnetic components as hazardous.⁷⁵ This standard requires that children's jewelry shall not have an as-received hazardous magnet or hazardous magnetic component, nor liberate a hazardous magnet or hazardous magnetic component, per testing specified in ASTM F963, with the exemption of children's jewelry intended for children 8 years of age or older consisting of earrings, brooches, necklaces, or bracelets. These products with hazardous magnets, as well as their instructions, if any, shall include warnings that address the following:

[For Earrings:] **WARNING** Contains small magnets. Swallowed or inhaled magnets can attract through and squeeze intestines or other body tissue, causing serious injury or death. Seek immediate medical attention if swallowed or inhaled. Use only on ears. Prolonged wearing can form a hole in body tissue. Change earring position regularly to release pressure. Do not keep on overnight.

[For all other jewelry:] **WARNING** Contains small magnets. Swallowed or inhaled magnets can attract through and squeeze intestines or other body tissue, causing serious injury or death. Seek immediate medical attention if swallowed or inhaled.

Compliance of manufacturers with this standard is uncertain, in part, due to the uncertain product identification in most incidents of magnet ingestion. Staff does not find this standard to be adequate. It includes only jewelry for children 12 years old and under, and therefore excludes other types of the subject magnet products. It includes unsafe exemptions for jewelry intended for children 8 years and older. The exemptions rely only on warnings to address the internal interaction hazard, and as detailed below, staff does not find warnings an adequate measure for preventing the hazard for the subject magnet products. Almost half of the incidents involved victims 8 years and older, above the age specified for these exemptions. In contrast to magnetic/electrical experimental sets subject to ASTM F963, which also have an exemption for children 8 years and older, staff has identified incidents implicating use of jewelry and magnets as jewelry in magnet ingestion incidents. Numerous ingestion incidents involved products described as bracelets, necklaces, piercings, and other jewelry. Use of magnetic jewelry or magnets as jewelry at the time of the incident was especially common for older children and teens, and some incidents involved children younger than 8 years acquiring magnets from products described as jewelry, such as finding the magnets in their environment. While the incident data are unclear regarding the manufacturer-intended ages of the involved products, use of magnets as jewelry and from

⁷⁵ However, the standard specifies that "hazardous magnetic component" does not include chains with a length greater than 6 inches.

jewelry in the mouth and nose is a foreseeable use pattern, and children and caregivers are unlikely to anticipate and appreciate the risk and consequences of ingestion, particularly for children absent a history of mouthing inedible objects.

3. ASTM F2999 – 19, *Standard Consumer Safety Specification for Adult Jewelry*

This voluntary standard for adult jewelry includes safety messaging recommendations for jewelry designed or intended primarily for use by consumers over age 12. This standard identifies a magnet as hazardous if it has a flux index *greater than 50* as measured by the method described in ASTM F963. This standard recommends that adult jewelry containing hazardous magnets as received *should* include a warning statement that addresses the following text:

WARNING. Contains magnets. Prolonged wearing can form a hole in body tissue. Swallowed or inhaled magnets can attract through and squeeze intestines or other body tissue, causing serious injury or death. Seek immediate medical attention if swallowed or inhaled.

Compliance of manufacturers with this standard is uncertain, in part, due to the uncertain product identification in most incidents of magnet ingestion. Staff does not find this standard to be adequate. It includes only jewelry for consumers over 12 years, and therefore excludes the other types of subject magnet products. It addresses the hazard only with a warning, which is recommended rather than required, and as detailed below, staff does not find warnings an adequate measure for preventing the hazard for the subject magnet products. Consistent with staff's concerns above regarding the children's jewelry standard, staff has found that numerous magnet ingestion incidents have involved products described as jewelry and magnets used as jewelry. These incidents include victims 13 years and older, as well as children 12 years and younger. While the incident data is unclear regarding the manufacturer-intended ages of the involved products, use of magnets as jewelry and from jewelry in the mouth and nose is a foreseeable use pattern, and children and caregivers are unlikely to anticipate and appreciate the risk and consequences of ingestion, particularly for children absent a history of mouthing inedible objects. Also, contrary to the current version of ASTM F963 and similar other standards and prohibitions discussed in this memorandum, this standard identifies a magnet as hazardous if it is *greater than 50 kG² mm²* as opposed to *50 kG² mm² or greater*, and staff recommends setting the limit consistent with ASTM F963.

4. ASTM F3458 – 21, *Standard Specification for Marketing, Packaging, and Labeling Adult Magnet Sets Containing Small, Loose, Powerful Magnets (with a Flux Index ≥ 50 kG² mm²)*

This voluntary standard for "adult" magnet sets includes marketing, packaging, labeling, and warning requirements for adult magnet sets with hazardous magnets, which the standard describes as intended for persons 14 years of age and older.⁷⁶ The standard identifies hazardous magnets consistent with ASTM F963. Through various safety messaging

⁷⁶ Regarding the use of "adult" to characterize these magnet sets, CPSC staff does not consider the age of majority to begin at 14 years; however, "adult" is used by ASTM to describe these products, which are not covered by ASTM F963.

requirements, the standard seeks to inform and encourage consumers to avoid the internal interaction hazard posed by these magnet sets. Through packaging requirements, the standard seeks to limit access to these magnet sets by children under 5 years of age. A summary of the requirements is provided below.

- Marking and labeling – Specifies warning statements to include on the outer packaging and required permanent storage containers for the magnet sets. Per section 8.7, at a minimum, the warning statements must include language that addresses the following: “Internal Injury Hazard,” “Keep away from ALL children,” “Swallowed magnets can cause damage to internal organs and have resulted in serious injuries or death,” “Be aware of dropped or separated magnets,” “Keep away from mouth and nose,” and “Seek immediate medical attention if magnet(s) were swallowed or inhaled.” The standard includes an example warning label (Figure 4 in the standard), which shows the following text:

WARNING
INTERNAL INJURY HAZARD

Swallowed magnets can damage internal organs and have resulted in DEATH and SERIOUS INJURIES.

- **Keep away from ALL children.**
- Be aware of dropped or separated magnets.
- NEVER put near mouth or nose.

Seek prompt medical attention if you think magnet(s) were swallowed or inhaled.

- Instructional literature – Specifies required instructions pertaining to assembly, maintenance, cleaning, storage, and use. Required content includes, but is not limited to, the following: the abovementioned warning statements, the manufacturer’s suggested strategy for counting and storing magnets, a description of typical hazard patterns (*e.g.*, young children finding loose magnets and teens putting magnets near their mouth or nose), an illustration of the hazard (example shown in Figure 2 of the standard), and a description of typical symptoms associated with magnet ingestion.
- Packaging – Requires that the product be sold with or in a permanent storage container. Regarding the warning labels for the retail packaging and permanent storage container, this standard specifies the minimum allowable type size for the “Warning” signal word, and for the warning text of the retail packaging. If the permanent storage container is not the retail packaging, then the minimum allowable type sizes for the permanent storage container are smaller. The permanent storage container must include a means for assuring that all magnets have been returned to the container, such as requiring a shape to repackage or directions for accounting for all the magnets. The permanent storage container must include one of three specified means of CR packaging: (1) it requires either two consecutive actions, the first of which must be maintained while the second is carried out, or two separate and independent simultaneous actions to fully release; (2) it requires one motion or action, which requires application of at least 15 lbf to open or alternatively requires at least four inches lbf of torque to open; or (3) it meets the performance requirements of 16 CFR 1700.15 and the testing requirements of 16 CFR

1700.20 (PPPA). The packaging must be re-closeable and maintain its CR features for a minimum of 360 open and close cycles, which are conducted at least 10 seconds apart. Additionally, the outer packaging must include a statement that the product is only for adults.

- Sales and marketing – Requires that manufacturers undertake “reasonable efforts” to ensure that the product is not marketed or displayed as a toy for persons under the age of 14, and that it is not sold to persons under 14 years of age or to anyone known to be buying it for someone under 14 years of age. Per section 5.2, examples of “reasonable efforts” include informing retailers about appropriate merchandizing practices. Specific to online sales direct from the manufacturer, the manufacturer must provide the abovementioned warnings, as well as instructional literature, including information about the hazard pattern.

Compliance of manufacturers with this standard is uncertain, in part, due to the uncertain product identification in most incidents of magnet ingestion, and the recency of the standard (it was approved in February of 2021 and published in March of 2021). Since March 2019, staff has participated actively in the ASTM F15.77 subcommittee on magnets, which developed ASTM F3458.⁷⁷ While staff contributed to the safety messaging and packaging requirements in ASTM F3458 – 21, and finds the required language to be informative, staff ultimately voted against publication of the standard, as staff does not find it adequate to effectively address the internal interaction hazard associated with adult magnet sets. This limited scope also means that the standard does not cover the other types of subject magnet products. Among other concerns identified in staff’s negative ballot letter (see Appendix), staff found that the requirements depended too heavily on unrealistic methods for persuading consumers to avoid the hazard, and the minimum allowable type size for the text of the warnings is too small for this hidden hazard. Staff reiterated throughout the standard development process that performance requirements are needed to prevent or effectively limit access to the hazard rather than only safety messaging and packaging requirements. At this time, a task group has been formed and is considering revising ASTM F3458 – 21 to include performance requirements for adult magnet sets. The subcommittee voted on May 25, 2021 to form the task group, with 15 voting members in favor and three opposed. Ongoing discussions include requiring magnets in adult magnet sets to have a flux index of less than 50 kG² mm² if the magnets are small objects; consistent with the requirements specified in ASTM F963 and this draft proposed rule. Staff is continuing to collaborate with ASTM F15.77; however, the future outcome of this effort is uncertain.

Safety Messaging and Packaging Requirements for the Subject Magnet Products

Staff finds that safety messaging and packaging requirements, in lieu of effective performance requirements, are unlikely to be adequate methods by which to address the internal interaction hazard posed by the ingestion of magnets from the subject magnet products. The following

⁷⁷ CPSC staff participates in various ASTM International (ASTM) subcommittee meetings, including ASTM F15.77 on magnets. ASTM subcommittees consist of members who represent producers, users, consumers, government, and academia. ASTM International website: www.astm.org, About ASTM International.

points include and expand on staff's findings documented in staff's 2020 informational briefing package regarding magnet sets.

Safety Messaging:

In general, safety literature has shown that warnings are the least effective strategy for addressing a hazard, relative to designing out the hazard or designing guards against the hazard (Sanders and McCormick, 1998). This is because safety messaging depends solely on persuading consumers to avoid hazards, and numerous factors, discussed below, can impede the likelihood of the safety messaging being read and followed consistently, particularly for the subject magnet products, as they are intended for amusement, jewelry, or both.

- *Consumers' common perception of low risk associated with the subject magnet products.* The subject magnet products are likely to appear simple, familiar, and non-threatening to children, teens, and caregivers. Incident data involving the subject magnet products, and consumer reviews, demonstrate that consumers commonly recognize these types of magnetic products as suitable playthings for children; this hinders the perceived credibility of warning information that states the magnets are hazardous for children. The marketing and use of similar magnet products may affect children's and caregivers' perceptions of the product. This tendency is referred to as stimulus-response generalization. Consumers tend to generalize across similar products once they become familiar with the products. Studies have found that the more familiar consumers are with a product, the less likely they are to look for, or read, warnings (Wogalter et al., 1999) and instructions (Inaba, Parsons, & Smille, 2004; Robinson, 2009; Schriver, 1997); consequently, it is more likely consumers will discredit or ignore the warnings (Ayres et al., 1986). In staff's 2012 NPR on magnet sets,⁷⁸ Sedney and Smith explained that if caregivers have observed either their child, or their child's peers using the product or a similar product without incident, caregivers may conclude that their child can use the product safely, regardless of what the warnings state (cf. Vredenburgh & Zackowitz, 2006). This is also true for recommendations from others, including online reviews of the subject magnet products, which can influence the likelihood of consumers disregarding the hazard. Staff analyzed numerous consumer reviews associated with subject magnet products, many of which indicated that consumers purchased the product for a child or that their children started playing with it. Similarly, repeated use of the product in or around the mouth without ingesting the magnets or experiencing consequences from ingestion is likely to convince these children and their caregivers that the hazard is not especially likely or is not relevant to them.
- *Misunderstood hazard.* The internal interaction hazard is a hidden hazard, and consumers are unlikely to anticipate and appreciate the vulnerability of children, especially older children and teens, who do not have a history of mouthing or ingesting inedible objects. Of the incidents that identify whether the ingestions were intentional or accidental, the majority describe accidental ingestion, which is much more difficult for consumers to comprehend and prevent. Approximately 39.6 percent of the NEISS-reported incidents and 45.2 percent of the CPSRMS-reported incidents identified victims

⁷⁸ Staff Briefing Package, Notice of Proposed Rulemaking for Hazardous Magnet Sets, August 8, 2012: https://cpsc.gov/s3fs-public/pdfs/foia_magnetstd.pdf.

8 years of age or older. Caregivers are unlikely to choose to keep the subject magnet products away from these populations, regardless of the warning information, and perceive such warnings as not pertaining to these children. This is primarily because they underestimate the potential severity of the hazard; or underestimate the likelihood that their child would ingest a magnet, let alone multiple magnets, or a magnet and a ferromagnetic object. Furthermore, there are developmental factors that predispose older children and teens to disregard warnings and use the subject magnet products in and around their mouth and nose. The hazard is also misunderstood by consumers in terms of the progression of symptoms. As shown in incident reports, many children, teens, and caregivers assume wrongfully that when ingested without any apparent choking episode, magnets may pass through the body without causing any harm. This contributes to delays between ingestion and correct treatment, increasing the risks associated with magnet ingestion.

- *Sources of access.* The subject magnet products are often acquired loose by children and teens from other children and teens, or found in their environment. These sources of access are not easily manageable by caregivers. Additionally, in such cases, any warning information displayed on packaging or instructions becomes immaterial, because children and teens are likely to access the magnets outside the packaging.
- *Historical inadequacy of similar efforts.* Incidents and consumer reviews indicate that children and teens have accessed hazardous magnets from the subject magnet products, even when there are prominent warnings, age labels, instructions, marketing, and packaging that attempt to identify the appropriate user population as adults, and warn about the internal interaction hazard. There are CPSRMS reports dating back to 2010, which indicate that the involved magnet sets had warnings about the hazard and identified adults as the appropriate user population. The following image (Figure 4) is an example of product marketing and warnings included in an incident report from 2011:

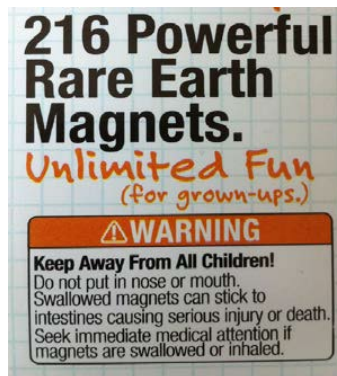

Figure 4. Example of marketing and warnings on retail packaging for a magnet set involved in a 2011 incident report.

In this example, the product was marketed to “grown-ups”; it had a warning to keep the product away from all children; and it included a clear internal interaction warning. Nonetheless, the product was involved in a magnet ingestion incident involving a 9-year-old child. This incident is not unique; staff has found numerous incident reports and

consumer reviews that indicate use by children of products that display similar marketing and warnings to the above image. As discussed above, at least 44 CPSRMS-reported incidents from the 2010 through 2020 time period (extracted on January 8, 2021) involved products with both magnet ingestion warnings and warnings to keep the product away from children. Considering additional cases received through mid-2021, staff has examined reports for 16 incidents involving children ingesting 2.5 mm diameter magnets from a specific magnet set intended for adults, and one incident involving a child inserting these magnets into his nose. These 17 incidents were recent, having occurred between 2018 and mid-2021, and the product had clear and repeated warnings about the hazard and against use by children. In one incident involving this product (April 2020), the victim's father indicated that he did not read any of the information that came with the product, and he believed the toy was age appropriate because he did not expect the victim to place magnets inside the victim's mouth, nor ingest the magnets. Nonetheless, the victim accidentally ingested magnets while playing, and required laparoscopic surgery for removal. Furthermore, in the 2020 informational briefing package regarding magnet sets, staff discussed their findings that of 41 magnet sets acquired from a domestic online marketplace and a domestic online retailer, about 35 percent of consumer reviews mentioned use by children and 68 percent had a magnet ingestion hazard warning.

Staff considered the historical ineffectiveness of other forms of safety messaging. Magnet ingestions involving the subject magnet products have continued an upward trend over the past years, despite over a decade of various consumer awareness raising activities. Since 2006, CPSC has drawn attention to the internal interaction hazard through recalls of children's magnet toys, safety alerts, a public forum, public safety bulletins, and rulemaking activity.⁷⁹ CPSC staff maintains a "Magnets Information Center" webpage on CPSC's website, which has links to recalls and articles, and vivid posters, videos, and written explanations of the internal interaction hazard.⁸⁰ For example, the webpage displays the following, graphic image (Figure 5):



Figure 5. Magnet ingestion warning poster on CPSC website. The message unambiguously implies that magnets are easy to swallow, but may need to be removed through surgery.

⁷⁹ Examples of efforts from the CPSC: in 2007, the CPSC developed a public safety alert about powerful magnets (<https://www.cpsc.gov/s3fs-public/5221.pdf>).

⁸⁰ For example, CPSC staff referred to posters, videos, and written explanations of the magnet ingestion hazard on CPSC's "Magnet Information Center" webpage: <https://www.cpsc.gov/Safety-Education/Safety-Education-Centers/Magnets>.

There have been numerous public outreach efforts by medical associations and other consumer advocacy groups to warn consumers about the internal interaction hazard posed by hazardous magnets used for amusement and jewelry. These groups include the American Academy of Pediatrics (AAP),⁸¹ the North American Society for Pediatric Gastroenterology, Hepatology and Nutrition (NASPGHAN),⁸² Consumer Reports,⁸³ Consumer Federation of America,⁸⁴ Kids in Danger,⁸⁵ and many others. There have also been articles on the internal interaction hazard from general news sources, including the Washington Post.⁸⁶ Even after years of safety messaging efforts from a large variety of sources, magnet ingestion incidents involving the subject magnet products are continuing to grow in number (see Tab B).

Packaging Requirements:

Staff finds that packaging requirements, including those specified in ASTM F3458, are likely to be similarly inadequate at preventing the hazard for the subject magnet products. Discussed above, magnets from the subject magnet products are often acquired loose from other children and teens and found in the environment, making packaging requirements, such as CR features and methods for visual verification of a full set, immaterial. For example, an in-depth investigation report for one incident from May 2020 indicates that the 6-year-old victim and her 12-year-old sister typically left their magnet set magnets out of their packaging, distributed on furniture pieces in various locations around the house. Additional concerns are listed below:

- *Ineffectiveness of CR features for the subject magnet products.* CR features would not be effective for preventing access by the majority of victims involved in magnet ingestion incidents (*i.e.*, those ages 5 years and older), as these children and teens are likely to have cognitive and motor skills beyond the ages for which CR packaging is designed to block access. While CR features may be capable of limiting access by children under 5 years old, the effectiveness would depend, in part, on the magnets being repackaged correctly and in their entirety after every use, which staff finds is unrealistic. Consumers are unlikely to reliably use CR packaging for the subject magnet products because the products are used for entertainment, jewelry, mental stimulation, and similar purposes, making them appear less threatening than the products often involved in chemical and pharmaceutical poisonings, for which inconsistent use of CR packaging by consumers has been problematic. CR packaging can also be perceived as a nuisance, making users less likely to store the magnets in the packaging after every use. For example, some of the subject magnet products, such as magnetic building and design sets intended for adults, are unlikely to be repackaged after every use if doing so requires consumers to

⁸¹ Magnets safety information on AAP website: <https://services.aap.org/en/search/?k=magnets>.

⁸² Magnets safety information on NASPGHAN website: <https://www.naspghan.org/content/72/en/Foreign-Body-Ingestion>.

⁸³ Example of 2017 Consumer Reports magnet hazard awareness-raising material on the Consumer Reports website: <https://www.consumerreports.org/product-safety/magnets-marketed-as-toys-could-be-dangerous-to-kids/>.

⁸⁴ Example of 2012 public outreach article from Consumer Federation of America: <https://consumerfed.org/testimonial/cfa-comments-cpsc-notice-proposed-rulemaking-safety-standard-magnet-sets/>.

⁸⁵ Example of 2011 public outreach article from Kids In Danger: <https://kidsindanger.org/2011/11/cpsc-warns-about-high-powered-magnets/>.

⁸⁶ For example, see The Washington Post article on surging magnet ingestion incidents, by Todd Frankel: https://www.washingtonpost.com/business/economy/number-of-children-swallowing-dangerous-magnets-surges-as-industry-largely-polices-itself/2019/12/25/77327812-2295-11ea-86f3-3b5019d451db_story.html.

disassemble their created designs, particularly if they spent considerable time and effort to build the designs and would prefer to display their designs. The effectiveness of CR packaging is also impacted by the size and quantity of the magnets in the product.

- *Implications of magnet size and quantity.* The subject magnet products are small enough to be swallowed, and some magnet products, particularly magnet sets and jewelry sets, may contain numerous, tiny magnets. In fact, some of these products involved in incident reports come in sets of thousands of 2.5 mm diameter magnets. The small size, and in some cases large quantity, of the magnets can make locating and counting the magnets after every use infeasible, and increase the costs of compliance (for consumers to heed the instructions), such as time and effort, beyond the actions consumers can and are willing to take. For example, some manufacturers of these products recommend creating a structure, such as a cube, to verify that all of the magnets are present, but the child and caregiver may not have the time, capability, or willingness to do this after every use. Research shows that increased costs of compliance with a warning can quickly drive compliance rates to zero (Dingus et al., 1991). In examining hazardous magnets, staff found that it was common for magnets to be flicked away from one another when handling, such as when separating magnets with one's thumb, resulting in magnets being dropped. These actions are foreseeable, particularly for magnets intended for fidgeting and building. The flicking motion may explain incident reports that describe magnets suddenly jumping into children's mouths while children were handling them. In examining magnet sets, staff found that many sets are sold with extra pieces, in part, because losing the magnets is expected by the manufacturer. Accordingly, many incident reports and consumer reviews for magnet sets mentioned lost magnets.

In conclusion, staff does not find safety messaging and packaging requirements to be adequate measures for addressing the hazard involving the subject magnet products. As such, because ASTM F3458 – 21 and ASTM F2999 – 19 include only safety messaging and packaging requirements and recommendations, they do not adequately address the magnet ingestion hazard. Similarly, because ASTM F2923 – 20 allows children's jewelry intended for children 8 years old and older to contain hazardous magnets as long as the products have warning statements, it also does not adequately address the magnet ingestion hazard.

D. Discussion of Prohibitions of Hazardous Magnets in Other Countries

Staff considered similar efforts taken by other countries to address the internal interaction hazard.

Canada's Regulations Regarding Hazardous Magnets

Since 2006, Health Canada has issued several advisories to warn Canadians of the dangers associated with ingesting magnets. Despite these warnings and some manufacturers' efforts to keep these products out of the hands of children, which have included package warnings, instructions on safe use, and guidance to retailers on safe selling practices, these magnets were

accessed and used by children, and incidents continued to occur.^{87,88} Canada addresses the internal interaction hazard associated with hazardous magnets similarly to the requirements recommended in this package, as summarized below.⁸⁹

1. Canada's Toys regulation SOR/2018-138 includes requirements for magnetic toys for use by children under 14 years of age.^{90,91} The requirements are consistent with ASTM F963, EN 71-1, and ISO 8124-1, including the identification and prohibition of hazardous magnets and magnetic components, and the exemption for magnetic/electrical experimental sets. It is important to note that the regulation includes toys with only one magnet to account for attraction to ferromagnetic objects, such as most Canadian coins.
2. Canada's general prohibition under the Canada Consumer Product Safety Act (CCPSA) includes separate requirements for products with hazardous magnets, which are not toys subject to SOR/2018-138.⁹² Paragraphs 7(a) and 8(a) of the CCPSA prohibit the manufacture, importation, advertisement, or sale of any consumer product that is a "danger to human health or safety." The requirements are consistent with ASTM F963, EN 71-1, and ISO 8124-1, including the identification and prohibition of hazardous magnets and hazardous magnetic components. The scope of the requirement includes the following products:
 - Novelty magnet sets, where the set is intended to be manipulated by consumers for entertainment, such as puzzle working, sculpture building, mental stimulation or stress relief;
 - Magnet sets containing more than one small, powerful magnetic piece in spherical, cube or cuboid shapes; and
 - Magnetic products with one or more magnets intended for entertainment or amusement of adults.

Australia's Regulations Regarding Hazardous Magnets

Australian/New Zealand Standard ISO 8124.1 aligns with ASTM F963's identification and prohibition of hazardous magnets in children's toys. This safety standard applies to toys containing magnets (magnetic toys) that are defined as designed or clearly intended for use in

⁸⁷ <https://www.canada.ca/en/health-canada/services/consumer-product-safety/advisories-warnings-recalls/letters-notices-information-industry/information-manufacturers-importers-distributors-retailers-products-containing-small-powerful-magnets.html>.

⁸⁸ <https://healthycanadians.gc.ca/recall-alert-rappel-avis/hc-sc/2013/31619a-eng.php>.

⁸⁹ Staff communicated with representatives from Health Canada's risk management bureau on July 7, 2021, to confirm staff's understanding of Canada's current requirements pertaining to hazardous magnets and Health Canada's justification for the requirements.

⁹⁰ <https://laws-lois.justice.gc.ca/eng/regulations/SOR-2011-17/index.html>.

⁹¹ <https://canadagazette.gc.ca/rp-pr/p2/2018/2018-07-11/html/sor-dors138-eng.html>.

⁹² Staff reviewed two documents from Health Canada, which explain Canada's "Notice of Danger to Human Health or Safety Assessment for Products Containing Small Powerful Magnets." These documents are available from Health Canada upon request.

play by children under 14 years of age and supplied with one or more magnets or magnetic components.

In addition, the Australian Competition & Consumer Commission (ACCC) issued a permanent ban on small, high-powered magnet toys and certain types of magnetic jewelry. The ban became effective on November 15, 2012, and remains in effect (Consumer Protection Notice No.5 of 2012).^{93,94} This ban focuses on separable or loose magnetic objects supplied in multiples of two or more, where the magnetic objects are, among other things, marketed by the supplier as, or supplied for use as, a toy, game, or puzzle (including, but not limited to, an adult desk toy; an educational toy or game; a toy, game, or puzzle for mental stimulation or stress relief), or a construction or modelling kit, or jewelry to be worn in or around the mouth or nose.

New Zealand's Ban on Certain Small, High-Powered Magnets

Australian/New Zealand Standard ISO 8124.1, aligns with ASTM F963's identification and prohibition of hazardous magnets in children's toys. This safety standard applies to toys containing magnets (magnetic toys) that are defined as designed or clearly intended for use in play by children under 14 years of age and supplied with one or more magnets or magnetic components.

New Zealand's Minister of Consumer Affairs also deemed small, high-powered magnets to be hazardous, issuing an Unsafe Goods Notice for magnet sets, which went into effect on January 24, 2013. This action was effective for 18 months and was subsequently converted into a permanent ban using language similar to Australia's ban.^{95,96} The ban applies to the following products:

- The sale and supply of small, strong magnets sold in sets of 2 or more in situations where children are able to access them; and
- New and second-hand small, high-powered magnets that are supplied, or offered or advertised for supply, in sets of 2 or more for personal use. Personal use includes magnet sets that form part of a toy, game or puzzle, construction or modelling kits, or jewelry that is worn around the nose or mouth.

The ban does not include hardware magnets, magnets used for teaching purposes by schools and universities, or those intended to become part of another product.

European Commission and Magnets in Consumer Products

The European Commission also uses for children's toys the requirements specified in EN 71-1. Regarding general use products with hazardous magnets, there is no safety standard under the General Product Safety Directive that would target magnets; however, Member States' market surveillance authorities generally apply EN 71-1 when assessing the risk posed by products that are not marketed as

⁹³ <https://www.productsafety.gov.au/bans/small-high-powered-magnets>.

⁹⁴ <https://www.legislation.gov.au/Details/F2012L02171>.

⁹⁵ <https://productsafety.tradingstandards.govt.nz/for-consumers/safety-with-specific-products/high-powered-magnets/>

⁹⁶ <https://www.consumer.org.nz/articles/high-powered-magnets-banned>

children's toys but are intended for children, and this includes "adult" magnet sets, as they are often bought for and used by children, even if they are marketed as toys for adults.

III. CPSC Staff's Recommended Rule

Staff recommends addressing the magnet internal interaction hazard through performance requirements pertaining to the subject magnet products, which limit the capability of ingested magnets to interact internally or limit their ingestion. As discussed above, safety messaging and packaging requirements are ineffective measures to address the hazard.

Staff also considered the use of aversive agents, which make use of sensory modalities other than vision, to make loose or separable hazardous magnets less appealing for children and teens to put in their mouths. As staff concluded in staff's previous packages on magnet sets, aversive agents, such as foul odors or bitterants, may dissuade some children and teens from placing hazardous magnets into their mouths; however, ultimately, such features would not be effective universally, and CPSC has found that aversive agents do not adequately deter or prevent ingestions.⁹⁷ Although the use of aversive agents might discourage some children from placing additional magnets in their mouth, incident reports indicate that serious injury is possible when one ingests as few as two magnets, or one magnet and a ferromagnetic object, and children might ingest multiple magnets before they detect the aversive agent. Children frequently ingest unpalatable substances, such as gasoline, cleaners, and ammonia, indicating that unpleasant taste or odor, alone, is not sufficient to deter children from ingesting items or substances. In addition, some portion of the population, possibly as high as 30 percent, may be insensitive to certain bitterants.

The sections that follow discuss staff's recommended product scope, performance requirements, and considerations to be solicited in public comments.

A. Recommended Product Scope

Staff recommends the scope include products with one or more magnets, which are loose or separable, and designed, marketed, or intended to be used by consumers for entertainment, jewelry (including children's jewelry), mental stimulation, stress relief, or a combination of these purposes. Although the majority of the magnet ingestion incidents lack certainty in product identification, staff concludes based on the points summarized below that it is reasonable that a substantial proportion of these incidents involved magnets from the subject magnet products.

Staff has found that, where product type was identified or described, incidents typically involved products identified or described for purposes of amusement or jewelry, such as magnetic desk toys and magnetic faux piercings/studs. Similarly, where interaction scenario was reported, incident reports overwhelmingly indicated the magnets were played with or used to simulate mouth piercings, at the time of the ingestions. These findings are not surprising, as staff considers it foreseeable that children are more likely to gain access to magnets intended for these non-threatening purposes of amusement and jewelry, and use the magnets in these common, hazardous manners (for play in and around the mouth and simulating mouth piercings). The

⁹⁷ Staff's previous packages on magnet sets, including staff's 2014 rule on magnet sets and staff's 2020 informational briefing package regarding magnet sets, conclude that aversive agents are unlikely to effectively prevent ingestion of magnets.

majority of the victims in the NEISS and CPSRMS datasets were under the age of 14, which is the cutoff age for children's toys subject to ASTM F963. These incidents include products marketed only to adults and with clear warnings about the hazard and against use by children. Magnet sets are one of the most common products identified in NEISS reports, and the most common product identified in CPSRMS reports. These products typically contain hundreds to even thousands of loose, hazardous magnets, and incidents involving these products demonstrate that children and teens continue to access and ingest these magnets despite strong safety messaging aimed at persuading them and their caregivers to avoid the hazard. Incidents grouped as "unidentified" had insufficient information to identify the magnet product category, although product characteristics and use patterns often shared commonalities with subject magnet products. These "unidentified" incidents typically describe the involved magnets as small balls, which is the most common shape used for magnet sets. CPSC staff finds it reasonable to conclude that incidents grouped as "unidentified" most likely involved magnets from the subject magnet products.

Discussed in the briefing memorandum, staff and other researchers have found that magnet-related incidents dropped substantially while the previous rule on magnet sets was in place, and rose substantially after it was vacated. Staff and other researchers conclude that this strong relationship is likely indicative of the success of the 2014 rule in appreciably reducing the number of magnet-related incidents while it was active. This decline and increase in magnet ingestions surrounding the magnet sets rule also indicates that the resurgence of incidents after the rule was vacated likely involved magnet sets, since they were the products subject to the rule.

Numerous consumer advocacy groups, including medical associations, have struggled to convey to the public the serious risks of harm posed by hazardous magnets in products used for amusement and jewelry, particularly magnet sets. Foreign regulators have prohibitions for magnet sets and hazardous magnets in other products in order to address this hazard. Staff agrees with these groups that the dangers of having loose or separable hazardous magnets in the subject magnet products outweigh the utility they add to amusement and jewelry.

Staff excluded from the scope of the draft proposed rule home/kitchen products, such as shower curtains and hardware, and products intended only for education/research, such as science kits used at schools or universities, contingent on these products not meeting the above criteria for the subject magnet products. While loose or separable hazardous magnets in these product types also present risk of the internal interaction hazard, staff finds the hazard to be less likely to occur with these products, which have functional utility different from amusement and jewelry, and which are therefore less likely to be acquired and used by children and teens for playing and jewelry. Staff did not find any incident reports that identified or described products intended only for education/research.⁹⁸ While staff did find incident reports involving home/kitchen products, only reports for two incidents indicated that surgery was required as a result of the magnet ingestion, and only one incident had evidence of internal interaction through tissue. Furthermore, staff observed only one incident reporting the use of magnets from home/kitchen products as jewelry. Children's toys subject to ASTM F963 are also excluded from the scope of the draft proposed rule. Based on the minimal presence of children's toys in incidents resulting

⁹⁸ There was one incident which alleged involvement of a product vaguely described as a "science kit," which had no information about intended use or user, and which therefore may have been a subject magnet product.

in internal interaction, as well as the very small number of recalls involving children's toys and the effectiveness of the ASTM F963 requirements, staff concludes that most children's toys on the market are compliant with the ASTM F963 and that the incident reports discussed above are likely due to subject magnet products including amusement/jewelry and unidentified product categories, not children's toys.

B. Recommended Performance Requirements

As discussed in Tab D, staff recommends that the subject magnet products comply with the magnet size and strength requirements established by ASTM F963. Under the draft proposed rule, the subject magnet products would comply with the standard if they meet either of the following criteria: (1) each magnet must be too large to fit entirely within the small parts cylinder described in 16 CFR 1501.4; or (2) each magnet must have a flux index of less than $50 \text{ kG}^2 \text{ mm}^2$, as measured by the procedures for determining the magnetic attractive force described in ASTM F963. This strength limit is discussed in Tab D of this briefing package. CPSC uses the small parts cylinder to assess whether an object is small enough for a child to ingest. These criteria pertaining to hazardous magnets were developed by consensus and are reiterated in other international standards, including EN 71-1 and ISO 8124-1.

Staff concludes that these size and strength limitations have been effective for addressing hazardous magnets in children's toys. Children's toys were rarely identified in incident reports describing internal interaction dating back to 2010, and the incidents of internal interaction involved products not compliant with the toy standard (such as recalled magnetic tile sets). In the years following the prohibition of hazardous magnets in ASTM F963 (2006 to 2009), there were a large number of recalls of children's toys with hazardous magnets.⁹⁹ The number of recalls have since diminished substantially (see Tab G), and staff attributes this decline to the effectiveness of ASTM F963.

As discussed above, similar limitations were incorporated in the 2014 rule on magnet sets (79 FR 59962), and staff and other researchers conclude the substantial decrease in magnet-related incidents around the 2014 rule, and the substantial increase in incidents after the rule was vacated, are likely indicative of the success of the 2014 rule in appreciably reducing the number of magnet-related incidents while it was active. Staff's recommended requirements are consistent with similar prohibitions by foreign regulators, such as Health Canada. Staff considered non-performance requirements, including pertaining to safety messaging, packaging, and aversive agents, and as detailed above, staff does not find such requirements, which depend on convincing consumers to avoid the hazard, to be adequate to address this hazard. Staff concludes that the recommended requirements for the draft proposed rule are necessary to effectively reduce the likelihood of injuries and deaths from children and teens ingesting hazardous magnets.

⁹⁹ Examples include the following: <https://www.cpsc.gov/Recalls/2006/childs-death-prompts-replacement-program-of-magnetic-building-sets>, <https://www.cpsc.gov/Recalls/2007/magnetix-magnetic-building-set-recall-expanded-serious-injuries-continue-to-be-reported>, <https://www.cpsc.gov/Recalls/2006/serious-injuries-prompt-recall-of-mattels-polly-pocket-magnetic-play-sets>, and <https://www.cpsc.gov/Recalls/2007/additional-reports-of-magnets-detaching-from-polly-pocket-play-sets-prompts-expanded>.

C. Comments to Solicit from the Public

There are several considerations for staff's recommended requirements, which warrant input from the public, and which may further be investigated through CPSC staff's continued sample testing, data analysis, and participation in ASTM subcommittees pertaining to hazardous magnets. CPSC staff is part of the ASTM F15.77 subcommittee on magnets, and is collaborating with other stakeholders in the development of performance requirements for magnet sets. These considerations for public comment include the following:

- Whether the product scope is adequate: Staff acknowledges that the internal interaction hazard is possible and documented for magnet products excluded from the recommended product scope, including products not intended for amusement and jewelry, such as "home/kitchen" products. Magnet products intended only for education/research are also currently excluded from the scope of the recommended requirements, and these products may, too, foreseeably be subject to the hazardous use patterns observed in the incident data involving the subject magnet products.
- Whether requirements for safety messaging and packaging are necessary: Considering that the lower limit for magnets to interact internally remains uncertain (see Tab D), staff invites public comment on requiring safety messaging and packaging requirements for the subject magnet products with loose or separable small parts magnets, regardless of their magnetic flux index, or to a specified magnetic flux index below 50. Staff is concerned regarding the potential for hazardous magnet products to have no safety information, and implied safety considering the draft proposed rule and absence of safety information.

IV. Conclusion

Staff recommends addressing magnet ingestion-related injuries involving consumer products by mandating performance requirements for consumer products that contain one or more magnets that are loose or separable, and designed, marketed, or intended to be used by consumers for entertainment, jewelry (including children's jewelry), mental stimulation, stress relief, or a combination of these purposes. Staff selected the subject magnet products to be included in the scope of the draft proposed rule based on staff's analysis of the following factors discussed in this memorandum: hazard patterns, child development, functional utility of hazardous magnets in consumer products, consumer reviews for products with loose or separable hazardous magnets, prohibitions in standards and other countries pertaining to hazardous magnets, contributions from various stakeholders in the ASTM F15.77 subcommittee on magnets, and the available literature.

Under the draft proposed rule, the subject magnet products would comply with the standard if either of the following is met: (1) each magnet must be too large to fit entirely within the small parts cylinder described in 16 CFR 1501.4; or (2) each magnet must have a flux index of less than $50 \text{ kG}^2 \text{ mm}^2$, as measured by the procedures for determining the magnetic attractive force described in ASTM F963. Through these performance requirements staff seeks to effectively reduce the likelihood of children and teens ingesting hazardous magnets, and consequently prevent deaths and serious injuries associated with the internal interaction hazard.

Staff assessed existing standards that address hazardous magnets and found that they are inadequate to effectively limit or prevent the internal interaction hazard associated with the subject magnet products. Furthermore, staff concludes that requirements for safety messaging, packaging, and aversive agents are unlikely to address effectively this serious and prevalent hazard, primarily due to the hidden nature of the hazard and the difficult-to-control chain of events that lead to injury.

Additionally, staff recommends soliciting comments on the following topics, which are detailed above: (1) whether the product scope is adequate; and (2) whether requirements for safety messaging and packaging are necessary.

V. References

- Brown, T., & Beran, M. (2008). Developmental stages of children. In R. Lueder & V. J. B. Rice (Eds.), *Ergonomics for Children: Designing Products and Places for Toddlers to Teens* (pp. 13–30). New York: Taylor & Francis.
- Dingus, T. A., Hathaway, J., & Hunn, B. P. (1991). A most critical warning variable: Two demonstrations of the powerful effects of cost on warning compliance. *Proceedings of the Human Factors Society 35th Annual Meeting*.
- Green, S. S. (2015). Ingested and aspirated foreign bodies. *Pediatrics in Review*, 36(10), 430–437. doi: 10.1542/pir.36-10-430.
- Inaba, K., Parsons, S.O. & Smillie, R. (2004). *Guidelines for developing instructions*. Boca Raton, FL: CRC Press.
- Knoll, L. J., Leung, J. T., Foulkes, L., & Blakemore, S. J. (2017). Age-related differences in social influence on risk perception depend on the direction of influence. *Journal of adolescence*, 60, 53–63. <https://doi.org/10.1016/j.adolescence.2017.07.002>
- Robinson, P. A. (2009). *Writing and designing manuals and warnings* (4th ed.). Boca Raton, FL: CRC Press.
- Sanders, M.S. & McCormick, E. J. (1993). *Human factors in engineering and design*. McGraw-Hill, Inc., New York, NY.
- Schrivver, K. A. (1997). *Dynamics in document design*. New York City, NY: Wiley.
- Sedney, C. A., & Smith, T. P. (2012). *Human factors assessment of strong magnet sets*. CPSC memorandum to Jonathan D. Midgett, Project Manager, U.S. Consumer Product Safety Commission, Bethesda, MD.
- Tomé, G., Matos, M., Simões, C., Diniz, J. A., & Camacho, I. (2012). How can peer group influence the behavior of adolescents: explanatory model. *Global journal of health science*, 4(2), 26–35. <https://doi.org/10.5539/gjhs.v4n2p26>
- Vredenburg, A. G., & Zackowitz, I. B. (2006). Expectations. In M. S. Wogalter (Ed.), *Handbook of Warnings* (pp. 345–354). Mahwah, NJ: Lawrence Erlbaum Associates.
- Wogalter, M.S., DeJoy, D., & Laughery, K. R. (Eds.). (1999). *Warnings and risk communication*. Philadelphia, PA: Taylor & Francis.

VI. Appendix

CPSC Staff Letter Responding to Ballot F15.77 (20-04), Item #1



U.S. CONSUMER PRODUCT SAFETY COMMISSION
5 Research Place, Rockville MD 20850

Stephen Harsanyi
Engineering Psychologist
Division of Human Factors

(301) 987-2209
sharsanyi@cpsc.gov

May 27, 2020

TRANSMITTED VIA EMAIL

Ms. Nancy Nord
Subcommittee Chairman for ASTM F15.77,
c/o ASTM International
100 Barr Harbor Drive, P.O. Box C700
West Conshohocken, PA 19428-2959

Dear Ms. Nord:

This letter responds to ASTM ballot F15.77 (20-04), item #1, *Specification for Marketing and Labeling Adult Magnet Sets Containing Small, Loose, Powerful Magnets with a Flux Index $\geq 50 \text{ kG}^2 \text{ mm}^2$ WK68963* ("draft standard").¹ Staff of the U.S. Consumer Product Safety Commission (CPSC) is voting negative on the ballot item.²

The draft standard seeks to minimize the hazard of children and teens ingesting magnets from magnet sets intended for adult use, by establishing requirements for warnings, instructions, marketing, and packaging ("proposed requirements"). Based on staff's technical expertise and its examination of magnet sets, incident reports, consumer reviews, and the available literature, staff concludes that relying only on the draft standard's proposed requirements is unlikely to effectively mitigate the hazard associated with the ingestion of small, powerful magnets from magnet sets. As discussed in staff's letter to the subcommittee on October 18, 2019, which explains staff's participation in the ASTM F15.77 effort, and staff's letter to the subcommittee on January 9, 2020, which explains staff's negative vote on the previous version of the draft standard proposed in ASTM ballot F15.77 (19-01), item #1, there are numerous factors that render the proposed requirements inadequate, including, but not limited to, the following:

1. *Consumer Common Recognition*: Studies show that consumers are unlikely to consult and heed warning information for products and features they perceive as simple, familiar, and non-

¹ The views expressed in this letter are those of CPSC staff and have not been reviewed or approved by, and may not necessarily reflect the views of, the Commission.

² 16 CFR part 1031, as amended in 2016, permits CPSC staff to vote and hold leadership positions on an optional basis, provided that such activities have the prior approval of CPSC's Office of the Executive Director. CPSC staff sought and received approval to vote in October 2019, on matters pertaining to ASTM subcommittee F15.77.

threatening, such as the subject magnet sets. Incident data and consumer reviews of magnet sets demonstrate that consumers commonly recognize magnet sets as suitable for children; warning information that suggests the contrary is unlikely to be perceived as credible. In addition, studies demonstrate that the more familiar consumers are with a product, the less likely they are to look for and read a warning; in contrast, consumers are more likely to discredit or ignore the warning. If caregivers have observed their child, or their child's peers, using the product, or a similar product, without incident, caregivers may conclude that their child can use the product safely, regardless of what the warnings state. Similarly, recommendations from other consumers and caregivers, including online reviews of magnet sets by others who have purchased these sets, can lead consumers to disregard the hazard.

2. *Required Repackaging:* Consumers are unlikely to repackage the sets in their entirety after each use, which is likely to be required to limit children's access to the sets and individual magnets. Magnet sets are designed and marketed for users to make complex sculptures, and for other purposes that discourage consumers from dismantling and repackaging the entire set. Magnet sets can have upwards of 1,000 tiny magnets, making the task of finding and collecting every individual magnet, after every use, difficult and time-consuming. Even small increases in time, effort, and other "costs," can have a substantial effect on compliance with a warning, and can quickly drive compliance rates to zero.
3. *Accessibility:* As evidenced in incident reports, magnets from magnet sets are often acquired by children without the packaging and instructions, such as from children sharing sets and children finding loose magnets in their environment. In such cases, any warning information limited to these sources, as well as packaging characteristics, are ineffective. Additionally, incident data show that the majority of victims have been 5 years or older, rendering the proposed child-resistant packaging requirements ineffective. For children under 5 years, users would have to repackage the magnet sets properly and in their entirety after every use for child-resistant packaging to be effective, which staff assesses as unlikely.
4. *Misunderstood Hazard:* It is typical for magnet ingestions by older children and teens to be accidental in nature, and consumers are unlikely to anticipate and appreciate the vulnerability of children and teens who do not have a history of mouthing inedible objects. Therefore, consumers are unlikely to keep the magnets away from these populations, regardless of warning information, which is likely to be perceived as not pertaining to these children.
5. *Characteristics of Older Children:* Older children are unlikely to comply with the warnings. It is evident in some incident reports that older children intentionally ingested magnets. Although older children presumably would be capable of understanding the danger posed by magnet ingestion, they are likely to give in to peer pressure, test limits, bend rules, and underestimate the risk and consequences. In fact, warnings about keeping magnet sets away from all children could have the unintended effect of making the product more appealing to these older children.
6. *Historical Inadequacy of Similar Efforts:* While some magnet sets are sold without warnings regarding the ingestion hazard, incidents and consumer reviews indicate that young children are continuing to access magnet sets even when there are prominent warnings, 14+ age labels, instructions, marketing, and packaging that attempt to communicate the appropriate user

population and warn about the ingestion hazard. Staff is aware of numerous incidents as early as 2010 that involved products with magnet ingestion hazard warnings. For example, an incident report from 2011 includes an image of magnet set packaging, which marketed the product to “grown-ups,” had a warning to keep the product away from “all children,” and included a clear magnet ingestion warning.³ Nonetheless, the product was involved in a magnet ingestion incident involving a 9-year-old child.

Additionally, in the appendix below, staff lists other concerns with the draft standard; however, resolution of these concerns, in staff’s technical opinion, would not adequately address the hazard.

Magnet ingestion is a significant concern of staff’s, primarily due to the hidden nature of the hazard, the vulnerable populations at risk, and the difficult-to-control chain of events that lead to injury and death. In staff’s briefing package, *Final Rule on Safety Standard for Magnet Sets*, dated September 3, 2014, a multidisciplinary team of CPSC staff concluded that warnings, even strengthened warnings, as well as other methods of addressing consumer behavior (e.g., bitterants, child-resistant packaging, and sales restrictions), would not adequately reduce the hidden hazard and risk of injury associated with magnet sets.⁴

Although staff appreciates the efforts of the ASTM F15.77 subcommittee, staff does not believe that this hazard can be addressed adequately by methods that rely only on overriding the common perception by consumers of the product as a suitable plaything for children, and on encouraging consumers to consistently and unrealistically alter their behavior in some way to avoid the hazard. Thus, staff cannot support the current ballot item. Staff looks forward to working with ASTM to develop requirements that effectively alleviate the hazard associated with the subject magnet sets.

Sincerely,

**STEPHEN
HARSANYI**

Stephen Harsanyi
Engineering Psychologist,
Division of Human Factors

Digitally signed by STEPHEN HARSANYI
DN: c.US, o=U.S. Government, ou=Consumer
Product Safety Commission, cn=STEPHEN
HARSANYI,
0.9.2342.19200300.3.0.1.1.410010004071803
Date: 2020.05.27 10:29:30 -0400

CC: Molly Lynyak, Manager, Technical Committee Operations, ASTM International
Susan Bathalon, CPSC Children’s Program Area Risk Manager
Patricia L. Edwards, CPSC Voluntary Standards Coordinator
Ben Mordecai, CPSC Toy Program Lead Testing Engineer

³ CPSC staff shared this incident, I1160250A, with ASTM F15.77 on March 31, 2020; however, the image is from the IDI, which was not shared with the subcommittee.

⁴ https://cpsc.gov/s3fs-public/pdfs/foia_SafetyStandardforMagnetSets-FinalRule.pdf

Appendix
Additional Concerns with the Proposed ASTM F15.77 Draft Standard

In addition to CPSC staff's above comments, staff notes the following concerns:

- "Adults" should not be defined in the draft standard as including children 14 years of age or older. The legal age of adulthood is not below 18 in any U.S. state. Furthermore, there have been incidents of magnet ingestion involving children 14 years of age and older.
- The draft instructions and packaging requirements for counting and storing magnets (sections 4.3 and 9.2.1, respectively), which are intended to assure that all magnets have been collected, can place unreasonable expectations and burdens upon consumers. For example, a manufacturer could meet these requirements by instructing consumers to produce a certain shape, such as a cube. However, consumers may lack the time, desire, or ability to construct a shape like this after every use.
- Section 8.5 should indicate clearly that the permanent storage container must have a minimum type size of 5.1 mm (0.2 inches) for the signal word and 2.0 mm (0.08 inches) for the warning text if the permanent storage container is the outer packaging for the product. As written, a permanent storage container used as the outer packaging may have a type size of 3.8 mm (0.15 inches) for the signal word and 1.5 mm (0.06 inches) for the warning text if the container is 50.8 mm (2 inches) or less. The ASTM F15.77 subcommittee agreed to this, after staff voiced concern that the warning should be larger for this product, explaining that the product is non-threatening in appearance and has a hidden hazard.
- The draft requirements in section 8.7 vary in numerous ways from the warning label exemplified in figure 3 of the draft standard. The language in figure 3 was developed by the Marking and Labeling task group and agreed upon by the subcommittee.
- There should be a requirement that information provided with the product, including in warning labels and marketing, shall neither contradict nor confuse the meaning of the required information or otherwise be misleading to the consumer.
- The draft standard allows the product to be marketed as a "toy," which can reduce the perceived hazardousness of the product, which is non-threatening in appearance, and suggest that the product is a suitable plaything for children.
- The illustration exemplified in figure 4 of the draft standard has not been tested, so it is unknown if it effectively will communicate the hazard to those that see it. The illustration is similar to a pictogram modified by staff, which, pre-modification, was created and tested for the CPSC by Kalsher & Associates, LLC (Contract HHSP233201860070A), and found to fail the comprehension criteria of ANSI Z535.3, *American National Standard Criteria for Safety Symbols* (2011; R2017).⁵ Although untested, the illustration does appear to address the concerns identified by Kalsher & Associates.

⁵ See <https://cpsc.gov/s3fs-public/CPSC%20Gather%20Consumer%20Feedback%20-%20Final%20Report%20with%20CPSC%20Staff%20Statement%20-%20REDACTED%20and%20CLEARED.pdf>; accessed on May 7, 2020.

- Draft section 9.2.3 specifies that the permanent storage container must continue to meet certain packaging options for child resistance after 360 open and close cycles. However, this 360 value is based on a limited, convenience sample of 281 customers of one manufacturer. Furthermore, the participants should have been asked about their past use rather than how many times they expected they would open and close a child-resistant storage container over an unspecified amount of time.

TAB D: Recommended Performance Requirements to Address Ingestion Injuries Associated with Hazardous Magnets



UNITED STATES
CONSUMER PRODUCT SAFETY COMMISSION
BETHESDA, MARYLAND 20814

Memorandum

Date: September 12, 2021

TO: Stephen Harsanyi, Hazardous Magnet Products Project Manager
Directorate for Engineering Sciences

THROUGH: Mark Kumagai, Assistant Executive Director
Office of Hazard Identification and Reduction

FROM: Caroleene Paul
Division of Mechanical and Combustion Engineering

SUBJECT: Recommended Performance Requirements to Address Ingestion Injuries
Associated with Hazardous Magnets

I. Introduction

Staff of the U.S. Consumer Product Safety Commission (CPSC) recommends rulemaking to address the internal interaction hazard associated with the ingestion of small, powerful magnets (“hazardous magnets”) by children and teens. When a person ingests two or more hazardous magnets (or a hazardous magnet and a ferromagnetic object) the magnets/objects may attract to each other in the digestive system, which can pinch or trap the intestinal walls or other digestive tissue between them, resulting in acute and long-term adverse health consequences or death. CPSC staff recommends addressing magnet ingestion-related injuries by mandating performance requirements for products with one or more magnets that are loose or separable, and designed, marketed, or intended to be used by consumers for entertainment, jewelry (including children’s jewelry), mental stimulation, stress relief, or a combination of these purposes (“subject magnet products”). These subject magnet products do not include “children’s toys” subject to the requirements in ASTM F963, *Standard Consumer Safety Specification for Toy Safety*, which is mandated by 16 CFR part 1250. The draft proposed rule would require that subject magnet products with individual, loose or separable magnets meet the following criteria:

- 1) Are too large to fit entirely within the CPSC’s small parts cylinder¹⁰⁰ (e.g., a ball-shaped magnet with a diameter of less than 31.7 mm, or 1.25 inches); or
- 2) Have a flux index less than 50 kG² mm², as measured by the procedures for determining the magnetic attractive force described in the toy standard.

¹⁰⁰ The small parts cylinder referenced in the rule is specified in 16 CFR part 1501—Method for Identifying Toys and Other Articles Intended for Use by Children Under 3 Years of Age Which Present Choking, Aspiration, or Ingestion Hazards Because of Small Parts.

In this memorandum, CPSC staff discusses:

- A description of the product;
- Adequacy of the existing voluntary standards to address the risk of injury associated with ingestion of hazardous magnets;
- Testing of magnet sets conducted by CPSC staff; and
- Staff’s recommended performance requirements.

II. Discussion

A. Products and Incidents

The magnet products covered by this recommended proposed rule include a variety of permanent magnets that are loose or separable, and designed, marketed, or intended to be used by consumers for entertainment, jewelry (including children’s jewelry), mental stimulation, stress relief, or a combination of these purposes. Examples of subject magnet products are shown in Figure 1 (see Tab C for detailed description of products).



Figure 1. Examples of a magnet set “executive desk toy,” a decompression pen magnet toy intended for adults, a magnetic jewelry set for children and adults, and “rock magnet” fidget toy (left to right, photos not to scale).

A permanent magnet is one that maintains its magnetic field after being removed from the magnetizing source. The most common are: Iron-Oxide (ferrite), Aluminum-Nickel-Cobalt (AlNiCo), Samarium-Cobalt (SmCo), and Neodymium-Iron-Boron (NIB). NIB and SmCo magnets are often referred to as “rare earth” magnets because Neodymium and Samarium are two of the 17 so-called “rare earth” elements found on the periodic table. CPSC staff has examined numerous samples of magnet products, particularly magnet sets, in support of the previous 2014 rulemaking,¹⁰¹ staff’s 2020 informational briefing package regarding magnet sets,¹⁰² staff’s involvement in ASTM activities, and staff’s support of Compliance enforcement efforts. Magnet sets are typically comprised of numerous identical, spherical, or cube-shaped magnets, approximately 3 to 6 millimeters in size, with the majority made from NIB. These magnets exhibit strong magnetic properties, including some in the range of 300 to 400 kG² mm²,

¹⁰¹ Briefing Package: Final Rule on Safety Standard for Magnet Sets (2014): https://cpsc.gov/s3fs-public/pdfs/foia_SafetyStandardforMagnetSets-FinalRule.pdf. Under the rule, if a magnet set contained a magnet that fit within the CPSC’s small parts cylinder, each magnet in the magnet set had to have a flux index of 50 kG² mm² or less. An individual magnet that was marketed or intended for use as part of a magnet set also had to meet these requirements. The flux index was determined by the method described in ASTM F963–11, Standard Consumer Safety Specification for Toy Safety.

¹⁰² CPSC staff’s informational briefing package regarding magnet sets, “Staff Briefing Package In Response to Petition CP 17-1, Requesting Rulemaking Regarding Magnet Sets,” dated June 3, 2020: https://cpsc.gov/s3fs-public/Informational_Briefing_Package_Regarding_Magnet_Sets.pdf?FKVcZpHmPKWCZNb7JE16Ir0a31WV72PI.

and the magnetized NIB cores are coated with a variety of metals and other materials to make the magnets more attractive to consumers and to protect the brittle magnetic alloy materials from breaking, chipping, and corroding. Often referred to as “magnet balls” or “rare earth magnets,” magnet sets commonly are marketed as toys for entertainment, such as adult desk toys, fidget toys, and building sets.

Incidents associated with magnet sets containing small diameter balls under 3 mm also are of concern. CPSC staff examined reports for 17 incidents involving 2.5 mm diameter spherical magnets from one brand of magnet sets.¹⁰³ Sixteen of these incidents indicate the magnets were ingested, and one incident involved magnets inserted into the victim’s nose. At least six of these 17 incidents involving 2.5 mm diameter spherical magnets, including the nasal insertion incident, involved internal interaction of the magnets through body tissue, and required medical intervention. At least 10 of these ingestion incidents resulted in surgery, and five had clear evidence of internal interaction through tissue, such as in the gastrointestinal (GI) tract, resulting in surgeries including appendectomy and bowel resection. The nasal insertion incident, which is detailed in Tab A, demonstrates attraction and perforation of two, 2.5 mm diameter spherical magnets through the victim’s nasal septum, which is tissue thicker than the GI walls. Reports for three of the remaining incidents indicate that surgery was required, but it is unclear from the reports if the magnets had interacted internally through tissue.

CPSC staff is also concerned about other types of loose, permanent magnets that are in the scope of products addressed by this briefing package. In particular, staff has examined samples of loose-as-received, ferrite magnets shaped like rocks (“rock magnets”) as shown in Figure 1. These rock magnets, and potentially different products described as “rock magnets,” have been involved in multiple ingestion incidents, including incidents resulting in surgery to address rock magnets that had attracted to one another internally through body tissue. Staff measured rock magnet strengths in excess of 700 kG² mm².

B. Assessment of Domestic Standards

Staff identified several voluntary and international standards that address the magnet internal interaction hazard. This section describes the domestic standards and staff’s assessment of the adequacy of the standards in addressing ingestion hazards posed by magnets; the next section addresses international standards.

1. ASTM F963-17, *Standard Consumer Safety Specification for Toy Safety*

ASTM F963-17 applies to toys, which are objects designed, manufactured, or marketed as playthings for children under 14 years old. The standard specifies that toys shall not contain a loose as-received hazardous magnet or a loose as-received hazardous magnetic component. ASTM F963-17 defines a “hazardous magnet” as one that is a small object (defined as an object that fits entirely within a cylinder, 1.25-inch diameter, as shown in the standard) and has a flux index equal to or greater than 50, as measured by the Magnet Test Method described in Section 8.25 of the standard. A “hazardous magnetic component” is any part of a toy that is a small

¹⁰³ Many of these cases occurred after the NEISS and CPSRMS data extraction discussed in Tab B and are therefore not captured in those datasets. These incidents include reports received up to and including August 22, 2021.

object and contains an attached or imbedded hazardous magnet. The standard also specifies that toys shall not liberate a hazardous magnet after being subjected to use and abuse testing consisting of the following in sequential order: soaking under water, cycling attachment and detachment, drop tests, torque tests, tension tests, impact tests, and compression tests.

Section 8.25.1 through 8.25.3 describe the test methodology to measure the maximum absolute flux of the magnet and to calculate the flux index. The flux index of a magnet is calculated by multiplying the square of the magnet's maximum surface flux density (in KGauss) by its cross-sectional area (in mm²). ASTM F963 test methodology specify a gauss meter and probe that measures the surface flux density at 0.015 inches (0.38 mm) above the magnet's surface. The area is measured at the largest cross section of the magnet that is perpendicular to the axis of its magnetic poles.

ASTM F963-17 includes an exemption for "magnetic/electrical experimental sets" intended for children 8 years and older that contain a loose as-received hazardous magnets or loose as-received hazardous magnetic component. For these products, the hazardous magnet or magnetic component does not have to meet the performance requirements for size and strength; instead, they are required to have specified safety labeling pertaining to the internal interaction hazard. The standard defines "magnetic/electrical experimental sets" as toys containing one or more magnets intended for carrying out educational experiments that involve both magnetism and electricity.

In 2007, ASTM issued ASTM F963-07, *Standard Consumer Safety Specification for Toy Safety*, which included provisions to address the magnet ingestion hazard in children's toys. In 2008, the Consumer Product Safety Improvement Act (CPSIA) mandated that ASTM F963 would be considered a mandatory consumer product safety standard. In accordance with this mandate, 16 CFR part 1250 currently requires toys to comply with ASTM F963-17, which is the most recent version of the standard.

ASTM revised the standard multiple times between the original 2007 version and the current 2017 version. With respect to products containing magnets, these revisions: (1) added the cyclic soaking requirements, (2) clarified procedures for single magnets, (3) added the definition for "magnetic/electrical experimental set," and (4) changed the definition of "hazardous magnet" from "greater than 50" to "greater than or equal to 50." Previously, the exemption for "magnetic/electrical experimental sets" applied to "hobby, craft, and science kit-type" items. Per section A12.4, this change in exemption from "hobby, craft, and science kit-type items" to "magnetic/electrical experimental sets" was intended to narrow the scope of products that could use the labeling exemption to only those that combine magnetism and electricity, such as electrical motors and doorbells.

CPSC Staff's Evaluation

ASTM F963-17 addresses magnet ingestion hazards with a two-part requirement:

- 1) Each magnet must be too large to fit entirely within the small parts cylinder (described in 16 CFR 1501.4), or

- 2) Each magnet must have a flux index (a calculated value of magnetic density and size) of $50 \text{ kG}^2 \text{ mm}^2$ or less.

Principles of safety engineering recommend eliminating hazards from the design of a product when possible. When this is not possible, safety features should be designed into the product and consumers should be alerted to the hazards by warning labels and other materials. ASTM F963 avoids ingestion hazards by requiring that the size of magnets be too large for a child to swallow according to the test method for identifying parts which present a choking or ingestion hazard, codified in 16 CFR Part 1501. When that is not possible, ASTM F963 requires the magnetic attractive force of the magnet to be below a threshold that was developed by the ASTM working group to address injuries involving strong magnets that separated from toys. 16 CFR part 1250 currently requires toys to comply with ASTM F963-17.

As discussed in Tab C, of the incidents for which a product type could be identified, only a minority of the identified magnet products involved in ingestion incidents were magnet toys subject to ASTM F963, and even fewer had evidence of internal interaction through tissue. Of the six cases involving toys subject to ASTM F963 with known internal interaction through tissue, all were products not compliant with the mandatory standard, including recalled products.¹⁰⁴

Based on the safety engineering approach used in ASTM F963 to address magnet ingestion hazards, and the incident data since the ASTM magnet requirements for toys have been in effect (and became mandatory through regulation), CPSC staff concludes that the magnet requirements in ASTM F963 adequately address ingestion hazards associated with loose magnets in children's toys. However, ASTM F963, on its own, is inadequate because it does not apply to magnet products intended for amusement of consumers 14 years and older, and it excludes adult jewelry and children's non-toy jewelry. As the incident data in this briefing package indicate, these additional products that are not subject to ASTM F963 are involved in magnet ingestion incidents. In addition, the incident data indicate that magnet incidents involve children ingesting magnets from products that are not intended for children or that are intended for older children. Staff recommends the magnet size and strength performance standards established by ASTM F963 for toy magnet products be used to address the same identified hazards in the subject magnet products.

2. ASTM F3458-21, *Standard Specification for Marketing, Packaging, and Labeling Adult Magnet Sets Containing Small, Loose, Powerful Magnets (with a Flux index $\geq 50 \text{ kG}^2 \text{ mm}^2$)*

In 2019, ASTM Subcommittee F15.77 on Magnets opened work item WK68963 to develop marketing, packaging, labeling, and warning requirements for adult magnet sets (intended for persons 14 years of age or older) containing small, powerful magnets (hazardous magnets). Staff participated actively in the working group and reiterated throughout the standard development process that performance requirements are needed to prevent or effectively limit access to the hazard rather than only safety messaging and packaging requirements. While staff contributed to

¹⁰⁴ Children's toy magnet building set recall expanded: <https://www.cpsc.gov/Recalls/2007/magnetix-magnetic-building-set-recall-expanded-serious-injuries-continue-to-be-reported>.

the safety messaging and packaging requirements in ASTM F3458 – 21, staff voted against publication of the standard because the final draft lacked performance requirements to adequately address the internal interaction hazard associated with adult magnet sets. In March 2021, ASTM published ASTM F3458, *Standard Specification for Marketing, Packaging, and Labeling Adult Magnet Sets Containing Small, Loose, Powerful Magnets (with a Flux Index $\geq 50 \text{ kG}^2 \text{ mm}^2$)*. The standard defines “magnet sets” as “an aggregation of separable magnetic objects that are marketed or commonly used as a manipulative or construction item for puzzle working, sculpture building, mental stimulation, education, or stress relief.” It defines “small, powerful magnet” as an “individual magnet of a magnet set that is a small object” and has a flux index of $50 \text{ kG}^2 \text{ mm}^2$ or more. The criteria for identifying a small object and the flux index are the same as in ASTM F963-17. ASTM F3458 specifies requirements that seek to inform and encourage consumers to keep magnets away from children. While the standard includes test methods consistent with F963-17 to determine if a magnet is a hazardous magnet, the standard does not include performance requirements preventing hazardous magnets from being used in magnet sets.¹⁰⁵ In May 2021, the ASTM F15.77 subcommittee formed a task group to consider development of such performance requirements for adult magnet sets. The task group last met in July 2021 and discussed adopting the ASTM F963 performance requirements, which would require magnets in certain adult magnet sets to have a flux index of less than $50 \text{ kG}^2 \text{ mm}^2$ if the magnets are small objects (see Tab C).

CPSC Staff’s Evaluation

Staff reiterated throughout the standard development process that performance requirements are needed to prevent or effectively limit access to the magnet ingestion hazard (rather than only safety messaging and packaging requirements) and staff voted against publication of the standard because the final draft did not include performance requirements to prevent hazardous magnets in magnet sets. ASTM F3458 currently does not include performance requirements to prevent hazardous magnets in magnet sets intended for consumers 14 years and older, and instead relies on requirements to inform and encourage consumers to keep magnets away from children. Staff is aware of incidents involving children ingesting magnets from products intended for adult amusement, particularly magnet sets outside the scope of ASTM F963. As Tab C explains, safety messaging and packaging requirements, without performance requirements, are not likely to adequately address the hazard. In addition, the standard applies only to adult magnet sets, and does not address other products in the scope of the draft proposed rule, such as jewelry. Therefore, staff concludes ASTM F3458 does not adequately address the hazard associated with the ingestion of hazardous magnets by children and teens.

3. ASTM F2923-20, *Standard Consumer Safety Specification for Children’s Jewelry*

ASTM F2923-20 establishes requirements and test methods for certain mechanical hazards in children’s jewelry, including ingestion, inhalation, and attachment hazards associated with hazardous magnets in children’s jewelry. This voluntary standard applies to jewelry that is designed or intended primarily for use by children 12 years old or younger, and includes criteria

¹⁰⁵ Because ASTM F3458-21 includes only marketing, packaging, labeling, and warning requirements, and no performance or technical requirements, the standard is discussed in more detail in Tab C.

for identifying children's jewelry. Section 3.2.4 defines hazardous magnet and hazardous magnetic component by referencing ASTM F963.¹⁰⁶ Section 13.1.1 states that children's jewelry shall not have an as-received hazardous magnet or an as-received hazardous magnetic component, and that children's jewelry shall not liberate a hazardous magnet or hazardous magnetic component after use and abuse testing specified in ASTM F963. However, Section 13.1.3 allows an exception for children's jewelry intended for children 8 years of age or older, consisting of earrings, brooches, necklaces, or bracelets and specifies that such products may have as-received hazardous magnets or hazardous magnetic components but must include a warning statement on the ingestion hazards of small magnets.

CPSC Staff's Evaluation

ASTM F2923 prohibits certain children's jewelry from having as-received hazardous magnets or as-received hazardous magnetic components. It refers to ASTM F963 for the identification of magnets and magnetic components as hazardous. However, ASTM F2923 allows as-received hazardous magnets or hazardous magnetic components in children's jewelry intended for children 8 years of age or older consisting of earrings, brooches, necklaces or bracelets (as long as the product includes a warning statement on the ingestion hazards of small magnets). As Tab C explains, almost half of the magnet ingestion incidents involved children 8 years and older, and use of magnets as jewelry at the time of ingestion was a common hazard pattern, particularly for this age group. Furthermore, warnings, packaging, and marketing requirements, alone, without performance requirements, are not likely to adequately address the hazard. Additionally, this voluntary standard applies only to children's jewelry, and therefore excludes other products included within the scope of this draft proposed rule, which are also indicated in ingestion incidents. Staff concludes ASTM F2923 does not adequately address the hazard associated with the ingestion of hazardous magnets by children and teens.

4. ASTM F2999-19, *Standard Consumer Safety Specification for Adult Jewelry*

ASTM F2999-19 establishes requirements and test methods for certain mechanical hazards in adult jewelry, which is jewelry designed or intended primarily for users over 12 years old. Section 3.1.5 defines hazardous magnet as "a magnet with a flux index >50 as measured by the method described in Consumer Safety Specification F963 and which is swallowable or a small object." Section 13.1 specifies that "adult jewelry that contains hazardous magnets as received should include a warning statement" on the ingestion hazards of small magnets.

CPSC Staff's Evaluation

ASTM F2999 allows adult jewelry to contain hazardous magnets that can be swallowed by children and that have flux indexes greater than $50 \text{ kG}^2 \text{ mm}^2$. Staff does not find this appropriate, as staff recommends aligning with ASTM F963's identification of magnets as hazardous (that is, greater than or equal to $50 \text{ kG}^2 \text{ mm}^2$). This voluntary standard recommends rather than requires a specified warning statement for jewelry containing small object magnets with a flux index greater than $50 \text{ kG}^2 \text{ mm}^2$. As Tab C explains, victims in magnet ingestion incidents included

¹⁰⁶ However, the standard specifies that "hazardous magnetic component" does not include chains with a length greater than 6 inches.

children over 12 years old, and use of magnets as jewelry at the time of the incident was a common hazard pattern. Incident data also indicates that children access and ingest magnet products that are intended for older consumers. Furthermore, warnings, packaging, and marketing requirements, alone, without performance requirements, do not adequately address the hazard. Additionally, this standard applies only to adult jewelry, and therefore excludes other products included within the scope of this draft proposed rule, which are also involved in ingestion incidents. Therefore, staff concludes ASTM F2999 does not adequately address the hazard associated with the ingestion of hazardous magnets by children and teens.

C. Assessment of International Standards

1. EN 71-1:2014, *Safety of Toys – Part 1: Mechanical and Physical Properties*

This European standard applies to toys for children, with toys being any product or material designed or intended, whether or not exclusively, for use in play by children of less than 14 years. The requirements for toys containing magnets are essentially the same as those found in ASTM F963-17. Section 4.23.2(a) states that any loose as-received magnet(s) and magnetic component(s) shall have either a flux index less than $50 \text{ kG}^2 \text{ mm}^2$, or shall not fit entirely in a small parts cylinder that is identical to the small parts cylinder shown in ASTM F963 (the dimensions are in millimeters instead of inches). The magnet flux index is determined the same way as in ASTM F963-17. EN 71-1 has similar use and abuse testing to ASTM F963 to ensure that hazardous magnet(s) or hazardous magnetic component(s) do not liberate from the toy. EN 71-1 also contains a similar exemption for magnetic/electrical experimental sets containing hazardous magnets intended for children 8 years of age and older; these sets are allowed to have hazardous magnets if the product carries a warning on the ingestion hazards of small magnets.

2. ISO 8124-1:2018, *Safety of Toys – Part 1: Safety Aspects Related to Mechanical and Physical Properties*

This international standard applies to all toys, meaning any product or material designed or clearly intended for use in play by children under 14 years of age. Section 4.31.2(a) states that any loose as-received magnet(s) and magnetic component(s) shall have either a flux index less than $50 \text{ kG}^2 \text{ mm}^2$, or shall not fit entirely in a small parts cylinder that is identical to the small parts cylinder shown in ASTM F963 (the dimensions are in millimeters instead of inches). The magnet flux index is determined the same way as in ASTM F963-17. ISO 8124-1 has similar use and abuse testing to ASTM F963 to ensure that hazardous magnet(s) or hazardous magnetic component(s) do not liberate from the toy. ISO 8124-1 also contains a similar exemption for magnetic/electrical experimental sets containing hazardous magnets intended for children 8 years of age and older; these sets are allowed to have hazardous magnets if the product carries a warning on the ingestion hazards of small magnets.

CPSC Staff's Evaluation

EN 71-1:2014, ISO 8124-1:2018, and ASTM F963 intentionally revised their requirements for magnets to align with one another in terms of definition of hazardous magnet, method to measure and calculate flux index, use and abuse tests, and definition and exemption for “magnetic/electrical experimental sets.” Based on the safety engineering approach used in

ASTM F963 to address magnet ingestion hazards, and the incident data since the voluntary standard magnet requirements have been in effect (and became mandatory through regulation), CPSC staff concludes that the magnet requirements in ASTM F963 and standards that are aligned with it, adequately address ingestion hazards associated with loose magnets in children's toys. However, ASTM F963 and the standards aligned with it, on their own, are inadequate because they exclude magnet products intended for amusement of consumers 14 years and older, and they exclude children's non-toy jewelry and adult jewelry.

D. ASTM Test Method

As discussed above, all four of the ASTM standards that address the magnet internal interaction hazard have similar criteria for identifying a hazardous magnet, including the same size criteria and the same flux index provisions, with the exception of the standard for adult jewelry, which identifies a magnet as hazardous if it is *greater than* $50 \text{ kG}^2 \text{ mm}^2$ as opposed to $50 \text{ kG}^2 \text{ mm}^2$ *or greater*. Because the requirements are similar across the standards, this section focuses on the flux index requirements in F963-17. ASTM F963 does not specify how many samples of a set/product, which may contain thousands of magnets, should be tested, and whether statistical sampling should be used to determine compliance. However, Section 4.38.1 states "Toys shall not contain a loose as-received hazardous magnet or a loose as-received hazardous magnetic component"; therefore, none of the loose magnets in the set/product may have a flux index of $50 \text{ kG}^2 \text{ mm}^2$ or greater. Consequently, staff considers a subject magnet product to fail if any loose or separable magnet from the product fits entirely within the small parts cylinder described in ASTM F963 and has a flux index of $50 \text{ kG}^2 \text{ mm}^2$ or greater. However, staff recommends seeking comments on how firms would test products to align with this requirement. Staff also recommends seeking comments on whether the rule should specify that a "representative sample" or at least one "representative sample" of each shape and size loose or separable magnet in a subject magnet product be tested, and how firms may satisfy such a requirement.

1. Test Method to Calculate Flux Index of Small Spherical Magnets

The flux index requirement specified in the toy standard was based on a method developed by the ASTM F15.22 Toy Safety subcommittee and was originally published in ASTM F963-07, *Standard Consumer Safety Specification for Toy Safety*. The method used an empirical value, known as the magnetic flux index, for estimating the magnet attraction force of individual single-pole magnets. When ASTM introduced the flux index limit in the standard in 2007, it established a flux index value of $50 \text{ kG}^2 \text{ mm}^2$ as a "safe" magnet, based on measurements of a number of magnetic toys that the ASTM subcommittee reviewed. At the time, magnets from toys involved in incidents had flux index measurements over $70 \text{ kG}^2 \text{ mm}^2$; and therefore, a flux index of $50 \text{ kG}^2 \text{ mm}^2$ was chosen to provide a factor of safety.

A magnet's composition, mass, and shape determine its magnetic field. This field is aligned with its north and south magnetic poles (see Figure 2). Surface flux density is a measurement of the magnetic field intensity at a given perpendicular distance above an area (dimension "x" in Figure 2). The maximum flux density is measured perpendicular to the pole surface of a magnet.

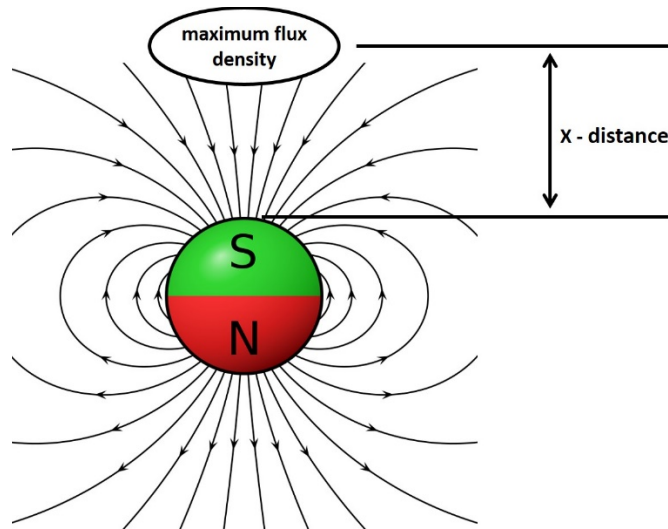

Figure 2. Magnetic field of spherical magnet.

The methodology in Section 8.25.1, *Magnet Test Methods: Flux Density Measurement*, describes how to measure the flux density of a magnet. The test is conducted using a direct current (dc) field gauss meter with a resolution of 5 gauss (G) capable of determining the field with an accuracy of 1.5 percent or better and an axial type probe with an active area diameter of 0.76 +/- 0.13 mm and distance between the active area and probe tip of 0.38 +/- 0.13 mm. Section 8.25.1.2 *Test Method* states: “move the probe [held perpendicularly to the magnet pole surface] across the surface to locate the maximum absolute flux density.”

CPSC staff determined that flux index measurement of large disc magnets is fairly straightforward and consistent values are obtained using the methods in ASTM F963. However, when measuring the flux index of tiny spherical magnets under 3 mm, staff encountered challenges finding the location of the poles due to difficulties in handling tiny spherical magnets. This may result in inaccurate measurements of the highest flux index values if the value is not measured above the magnet’s pole.

To improve accuracy and consistency in measuring the flux index for small diameter magnets, staff developed a test procedure to locate the magnet pole and to secure the magnet on a base rather than holding the magnet. This test procedure, which is consistent with ASTM F963, resulted in improved accuracy and consistency for measuring the maximum flux density and calculating the maximum flux index. The method consists of the following steps (detailed procedure in Appendix):

- 1) Use a flat magnetic or ferromagnetic utensil to attract spherical magnets into alignment with pole orientation towards the utensil.
- 2) Transfer the spherical magnets from the utensil to a flat surface covered in at least 2 mm depth of putty that is dense/thick enough to maintain the configuration of the spherical magnets in the proper pole orientation (established by magnetic attraction with the utensil).

- 3) With the spherical magnets aligned in the flat surface putty with pole orientation facing away from the test surface, use the gauss meter probe to determine the maximum flux value of each individual magnet.

2. Results of Tests Conducted by CPSC Staff on 2.5 and 3 mm Spherical Magnets

In March 2021, using the abovementioned technique, staff conducted inter-rater reliability testing (*i.e.*, the extent to which two or more observations agree) in which three staff tested the same 21 exemplar 2.5 mm diameter spherical magnets; three magnets were tested from each of seven sets/samples of the same magnet set brand (see Table 1). ASTM F963-17 does not specify how many magnets of a magnet set should be tested to determine compliance with the performance requirement maximum (*i.e.*, must be less than 50 kG² mm²). Staff chose three magnets from each set to analyze intra-set variability in magnetic flux index.

Table 3. Inter-rater Reliability Test Measurements of Spherical Magnets (March 2021)

Test Set	Magnet 1 (kG ² mm ²)			Magnet 2 (kG ² mm ²)			Magnet 3 (kG ² mm ²)		
	Tester 1	Tester 2	Tester 3	Tester 1	Tester 2	Tester 3	Tester 1	Tester 2	Tester 3
1	53.788	56.294	42.730	48.950	50.797	47.197	50.797	53.246	50.462
2	59.477	60.876	53.926	52.055	54.175	40.755	53.372	56.197	74.308
3	29.021	29.627	28.191	29.205	30.752	27.507	39.152	41.192	35.507
4	33.226	33.932	31.232	51.627	54.623	36.160	53.605	53.705	42.825
5	42.940	41.681	46.425	52.600	51.631	48.106	46.501	48.576	44.031
6	34.381	34.838	34.217	40.974	40.279	39.920	35.085	36.197	33.905
7	55.118	56.522	53.955	56.819	57.577	56.230	40.890	34.274	39.933

Test results from this limited study indicated the following:

- In general, magnets from the same set tended to be closer to one another in flux index than magnets between sets; and
- Flux index measurements of 21 exemplar 2.5 mm diameter spherical magnets from seven different magnet sets of the same brand ranged from 27.507 to 74.308. A single flux index measurement of 50 or greater would fail the draft proposed flux index threshold.

In March and April 2021, three staff tested spherical magnets from four separate sample/sets that were involved in internal interaction incidents (see Table 2). One set (Set “1” in Table 2) included a single 2.5 mm diameter magnet that had not been ingested but was from a set of ingested magnets that had interacted internally through a victim’s body tissue. The remaining three sets had magnets that were ingested and removed from the intestines of the victim who swallowed the magnets (*i.e.*, interacted internally through victims’ body tissue). Three magnets from each of these three sets were tested; two of the three sets were composed of 3 mm diameter magnets and one set was composed of 2.5 mm diameter magnets.

Table 4. Test Measurements of Spherical Magnets Sets Involved in Ingestion Incidents

Set	Magnet 1 (kG ² mm ²)			Magnet 2 (kG ² mm ²)			Magnet 3 (kG ² mm ²)		
	Tester 1	Tester 2	Tester 3	Tester 1	Tester 2	Tester 3	Tester 1	Tester 2	Tester 3
1	42.020	45.173	41.766	N/A	N/A	N/A	N/A	N/A	N/A
2	76.919	82.469	65.959	72.911	70.882	63.795	70.206	68.475	63.843
3	46.239	48.513	46.384	47.536	49.427	47.991	48.309	52.135	48.749
4	93.979	96.426	89.349	90.240	96.383	88.218	89.070	94.970	95.712

Test results from this limited test effort indicated the following:

- Flux index measurements from one 2.5 mm diameter spherical magnet (same brand as above) ranged from 41.766 to 45.173. This exact magnet was not ingested, and staff is unable to determine if the ingested magnets from this magnet set, which interacted internally through a victim’s body tissue, would have measured below 50, as well.
- Flux index measurements of three 2.5 mm diameter spherical magnets from one magnet set (same brand as above) ranged from 46.239 to 52.135. These exact magnets had been ingested and had interacted internally through a victim’s tissue.
- Flux index measurements of six 3 mm diameter spherical magnets from two different sets of unknown manufacturers ranged from 63.795 to 96.426. These exact magnets had been ingested and had interacted internally through a victim’s tissue.

In June 2021, CPSC staff tested magnets from two more exemplar magnet sets of the same brand (one model with colored magnets and one model with uncolored magnets), each of which consisted of spherical rare-earth magnets that were 2.5 mm in diameter (see Table 3). Staff measured the flux index of three magnets from each set and calculated the flux index values.

Table 5. Test Measurements of Two 2.5 mm Diameter Magnet Sets (June 2021)

Magnet	Sample Magnet Set 1					Sample Magnet Set 2				
	Max Flux (kG)	Max Flux ² (kG ²)	Diameter (mm)	Area (mm ²)	Flux Index	Max Flux (kG)	Max Flux ² (kG ²)	Diameter (mm)	Area (mm ²)	Flux Index
1	2.812	7.907	2.520	4.985	39.417	3.343	11.174	2.520	4.985	55.705
2	2.714	7.363	2.550	5.104	37.585	3.450	11.903	2.590	5.266	62.677
3	2.798	7.826	2.410	4.559	35.683	3.275	10.726	2.530	5.025	53.896

Flux index measurements of six 2.5 mm diameter spherical magnets from two different magnet sets of the same brand ranged from 35.683 to 62.677. A single flux index measurement of 50 or greater would fail the recommended flux index threshold in the draft proposed rule.

3. Discussion

The recommended draft proposed rule would require that subject magnet products having individual, loose or separable magnets be too large for a child to swallow (according to the test method for identifying parts which present a choking or ingestion hazard, codified in 16 CFR

Part 1501) or have a flux index less than $50 \text{ kG}^2 \text{ mm}^2$. Individual magnets in a magnet set are loose or separable; therefore, each magnet in a magnet set comprised of multiple spherical balls would have to have a flux index less than $50 \text{ kG}^2 \text{ mm}^2$.

Staff tested samples of 2.5 and 3 mm diameter spherical magnets using procedures in the Appendix. Regarding the exemplar 2.5 mm magnets, staff measured flux index values between 27.507 to $74.308 \text{ kG}^2 \text{ mm}^2$. Regarding incident samples with magnets involved in internal interaction injuries, staff measured flux index values from 46.239 to $52.135 \text{ kG}^2 \text{ mm}^2$ for the 2.5 mm magnets, and 63.795 to $96.426 \text{ kG}^2 \text{ mm}^2$ for the 3 mm diameter magnets. Consistent with ASTM F963, staff considers a magnet product to fail the proposed requirement of a flux index of less than $50 \text{ kG}^2 \text{ mm}^2$ if at least one magnet from the product exceeds the maximum flux index. Based on staff's testing of magnets in magnet sets that were involved in ingestion incidents, the recommended rule would address the ingestion hazard by prohibiting the majority of these magnet sets because staff measured at least one magnet from each set with a flux index greater than $50 \text{ kG}^2 \text{ mm}^2$.

III. Staff recommendation

CPSC staff recommends performance requirements for consumer products that contain one or more magnets that are loose or separable, and designed, marketed, or intended to be used by consumers for entertainment, jewelry (including children's jewelry), mental stimulation, stress relief, or a combination of these purposes. Under the draft proposed rule, any loose or separable magnets in these products must meet the following criteria:

- 1) Each magnet must be too large to fit entirely within the small parts cylinder described in 16 CFR 1501.4, (e.g., a ball-shaped magnet with a diameter greater than 1.25 inches or 31.7 mm); or
- 2) Each magnet must have a flux index of less than $50 \text{ kG}^2 \text{ mm}^2$, as measured by the procedures for determining the magnetic attractive force described in the ASTM F963 toy standard.

When a person ingests two or more hazardous magnets (or a hazardous magnet and a ferromagnetic object), the magnets/objects may attract to each other in the digestive system, which can pinch or trap the intestinal walls or other digestive tissue between them, resulting in acute and long-term adverse health consequences or death. Staff is aware of incidents involving magnet products that are outside the scope of ASTM F963 because of intended use or other exemptions; yet staff's testing indicates the magnet products would fail the flux index requirements in ASTM F963.

The recommended draft proposed rule addresses ingestion hazards by requiring that the size of magnets be too large for a child to swallow according to the test method for identifying parts which present a choking or ingestion hazard, codified in 16 CFR Part 1501. When that is not possible, the recommended draft proposed rule requires the magnetic attractive force of the magnet to be below a threshold that was developed by the ASTM F963 working group to address injuries involving strong magnets that separated from toys. In addition to the basis ASTM originally used to identify this limit of under $50 \text{ kG}^2 \text{ mm}^2$ as a safe threshold, staff also finds this limit is an effective one based on incident data for children's toys. As discussed, children's toys

represented a very low number of the NEISS- and CPSRMS-reported magnet ingestions (where the product could be identified) and, when magnet ingestions did occur with children's toys, they rarely resulted in the internal interaction hazard, and those that did result in internal interaction, did not comply with the toy standard. This indicates that the threshold of under $50 \text{ kG}^2 \text{ mm}^2$ is effective at reducing the risk of injury from magnet ingestions. Also, as indicated above, the most common subject magnet products staff identified are 3 to 6 mm and have flux indexes of 300 to $400 \text{ kG}^2 \text{ mm}^2$. A flux index limit of less than $50 \text{ kG}^2 \text{ mm}^2$ would address these products and would also address the subject magnet products with flux indexes closer to $50 \text{ kG}^2 \text{ mm}^2$ (e.g., the smaller magnets with test results above). By establishing a limit of under $50 \text{ kG}^2 \text{ mm}^2$, in order to account for manufacturing variance, manufacturers complying with the rule are likely to fabricate magnets below this limit. For these reasons, staff recommends proposing a flux index limit of under $50 \text{ kG}^2 \text{ mm}^2$ as part of the draft proposed rule. However, as staff's testing of a small number of ingested incident magnets that resulted in internal interaction injuries indicates (see Table 2, row 3), magnets from subject magnet products have yielded varied flux index readings, with some being close to, but below $50 \text{ kG}^2 \text{ mm}^2$. It is unknown if these magnets under $50 \text{ kG}^2 \text{ mm}^2$ would have interacted internally absent involvement of the magnet that measured over $50 \text{ kG}^2 \text{ mm}^2$. For this reason, staff recommends seeking comments on whether a lower flux index limit may be warranted, including test and safety information supporting any such comments.

Staff also recommends using the flux index methodology in ASTM F963 as part of the draft proposed rule to determine the flux index of subject magnet products. Staff concludes this methodology is effective for accurately assessing the strength of subject magnet products because it is a long-standing and effective method that was developed by consensus of experts and others in the field and used widely by other standards and countries. Staff considers this methodology an effective way to measure the strength of magnets, which is relevant to the safety hazard. However, as the small number of tested magnets from subject magnet products above indicates, there can be variability in flux index results for smaller magnets when using that methodology. In addition, there are potential alternatives to this method, such as considering attraction and repulsion forces. For that reason, staff recommends seeking comments on variability in flux index results, determining the flux index of smaller magnets, and potential refinements to the methodology. To improve accuracy and consistency in measuring the flux index for small diameter magnets, staff developed a test procedure consistent with ASTM F963 to locate the magnet pole and to secure the magnet on a base rather than holding the magnet. This test procedure is submitted in the Appendix. The additional detail in staff's method would be one option for potentially refining the test method in ASTM F963.

Staff recommends soliciting comments on the following topics:

- Application of the ASTM F963 test method for measuring flux density, particularly to test small diameter spherical magnets in the 2 to 3 mm diameter range.
- Variances in flux density measurement of small spherical magnets, for instance due to correct identification of pole surfaces, accurate measurement of maximum absolute flux density, accurate calculation of maximum cross section of the magnetic poles.
- Whether the rule should, instead, specify that a "representative sample" or at least one "representative sample" of each shape and size loose or separable magnet in a subject magnet product be tested, and how firms may satisfy such a requirement.

- Whether statistical sampling should be used with subject magnet products that include numerous, loose or separable magnets, such as magnet sets comprising hundreds of individual magnets.
- Whether to include testing considerations for magnets liberating from the subject magnet products, such as specified in ASTM F963.
- Any new data on whether magnets with flux indexes less than $50 \text{ kG}^2 \text{ mm}^2$ pose concern for the internal interaction hazard.

IV. Appendix

Example Test Method for Measuring Flux Index of Small Spherical Magnets

To measure the flux index for small spherical magnets that are 2 to 3 mm in diameter, staff developed the following test methodology with the objective of reducing variability in test results due to difficulties in handling small objects and in determining the location of the poles.

Typically, staff measures the surface flux density of a magnet by holding the magnet between the thumb and index finger, using a magnetic field viewer (film that shows magnetic field lines) to locate the magnet's poles, and measuring the maximum surface flux density perpendicular to that pole surface. Due to the small size and shape of spherical magnets in the 2 to 3 mm diameter range, staff refined the way the magnets are secured to improve the accuracy of the maximum flux density measurements.

- 1) Acceptance limits and requirements. Magnets that fit completely within the small parts cylinder (described in 16 CFR 1501.4) must have a flux index less than $50 \text{ kG}^2 \text{ mm}^2$.
- 2) Test Equipment.
 - a. Direct current field gauss meter with a resolution of 5 gauss (G) and an axial type probe, capable of determining the field with an accuracy of 1.5 percent or better.
 - b. Flat ferromagnetic bar nominally large enough to attract and hold test magnet sample(s).
 - c. Clay/putty of sufficient density to hold magnet sample.
 - d. Flat board or countertop that is not magnetic.
 - e. Calipers or similar device with resolution of 0.1 mm.
- 3) Test Method.
 - a. Measure the diameter of the magnet sample with the calipers.
 - b. Affix the test magnet to the ferromagnetic bar through its attraction to the bar. This establishes the pole orientation of the magnet. This can also work with ferrous calipers.

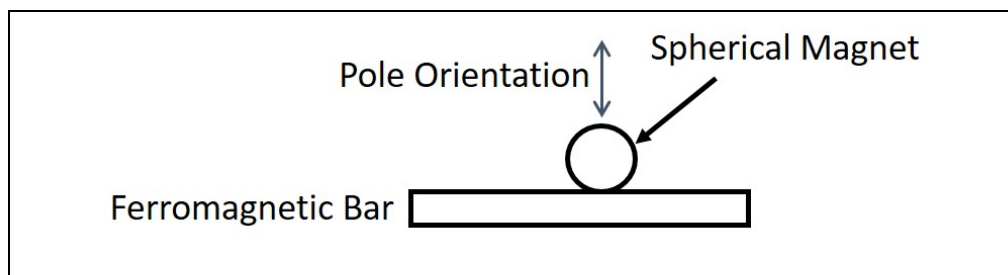

- c. Spread clay/putty on flat counter/surface to a depth of 2mm (or at least half the diameter of the sample magnet) and a surface area that will encompass the sample magnet.
- d. Holding the bar with the sample magnet parallel and facing towards the clay/putty table surface, lower the bar and press the magnet into the clay/putty. Maintain the orientation of the spherical magnet when transferring to clay/putty. **Do not exceed more than 50 percent in depth as this will limit the accessibility of the probe.**

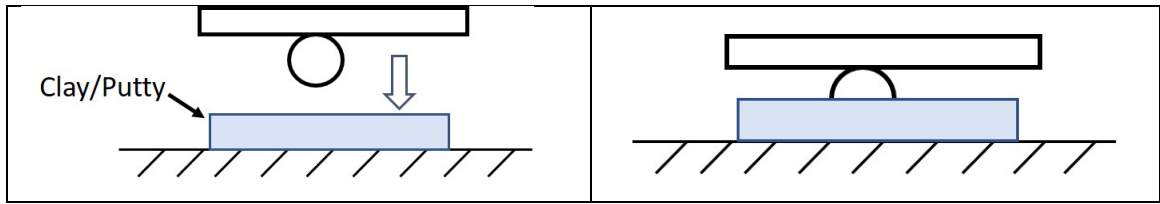

- e. Once magnet is stabilized in clay/putty, remove flat bar. Spherical magnet is now held in clay/putty with magnetic pole perpendicular to the table surface.

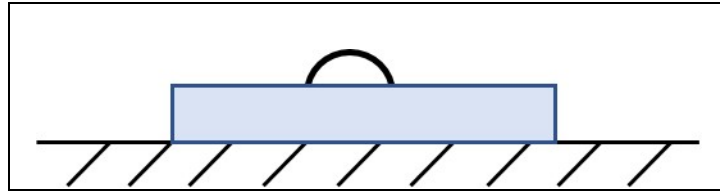

4) Test Procedure

- a. Position gauss meter probe tip in contact with the pole surface of the magnet.
- b. Keep gauss meter probe perpendicular to pole surface.
- c. Move the probe across the surface to locate the maximum absolute flux density.
- d. Record the maximum absolute flux density.
- e. Calculate the cross-sectional area of the spherical magnet.

$$A = \pi r^2$$

$r = \text{radius (mm)}$
 $= \frac{1}{2} \text{ diameter (mm)}$

- f. Calculate the flux index ($\text{kG}^2 \text{mm}^2$) by multiplying the area of the pole surface (mm^2) of the magnet by the square of the maximum flux density (kG^2).

5) Performance requirement.

- a. The flux index shall be less than $50 \text{ kG}^2 \text{mm}^2$.

**TAB E: Preliminary Regulatory Analysis of a Draft Proposed Rule that
Would Establish a Standard for Hazardous Magnet Products**



**UNITED STATES
CONSUMER PRODUCT SAFETY COMMISSION
BETHESDA, MARYLAND 20814**

Memorandum

Date: September 12, 2021

TO: Stephen Harsanyi, Hazardous Magnet Products Project Manager
Directorate for Engineering Sciences

THROUGH: Robert L. Franklin, Senior Staff Coordinator, Acting Associate Executive
Director, Directorate for Economic Analysis

FROM: Charles L. Smith, Economist, Directorate for Economic Analysis

SUBJECT: Preliminary Regulatory Analysis of a Draft Proposed Rule that Would Establish
a Standard for Hazardous Magnet Products

I. Introduction

Continuing concern with magnet ingestion-related injuries led the Consumer Product Safety Commission (Commission or CPSC) to direct in FY 2021 the development of a Notice of Proposed Rulemaking (NPR) addressing the hazard. In this briefing package, CPSC staff recommends that the Commission mandate performance requirements to address the internal interaction hazard associated with the ingestion of small, powerful magnets (“hazardous magnets”) by children and teens. Hazardous magnets are small enough to be swallowed by young children and strong enough to attract through body tissues, posing risks of death and serious harm.

The primary purpose of this preliminary regulatory analysis is to evaluate the potential benefits and costs of a draft rule to address hazardous magnets. In addition, this preliminary regulatory analysis addresses reasonable alternatives to the draft proposed rule, and their potential costs and benefits.¹⁰⁷

II. Discussion

A. Draft Proposed Rule

The draft proposed rule would establish mandatory performance requirements for products with one or more magnets, which are loose or separable, and designed, marketed, or intended, to be used by consumers for entertainment, jewelry (including children’s jewelry), mental stimulation, stress relief, or a combination of these purposes (“subject magnet products”). The subject magnet products do not include “children’s toys” subject to the requirements in

¹⁰⁷ A preliminary regulatory analysis must also address any standards submitted to the Commission, however, no such standards were submitted for this rulemaking.

ASTM F963, *Standard Consumer Safety Specification for Toy Safety*, which is already mandated by 16 CFR part 1250 to meet the same performance requirements as proposed here. “Children’s toys” are objects that are designed, manufactured, or marketed as playthings for children under 14 years old. Under the draft proposed rule, subject magnet products would comply with the standard if the following: (1) the individual magnets are not small enough to fit entirely within the CPSC’s small parts cylinder;¹⁰⁸ or (2) the individual magnets have a flux index of less than $50 \text{ kG}^2 \text{ mm}^2$, as measured by the procedures for determining the magnetic attractive force described in ASTM F963.¹⁰⁹ Because these requirements already apply to magnets used in products marketed as toys for children, the rule essentially extends the magnet size and strength requirements for children’s toys to the subject magnet products. The draft proposed rule would not apply to magnet products intended for education and research and/or home and kitchen (such as shower curtains and magnetic closures) purposes, which do not also fit the criteria of the subject magnet products; for example, a magnet product intended only for education/research at a university, and not intended for amusement or jewelry, would be excluded from the scope of the draft proposed rule.

B. Preliminary Regulatory Analysis

Pursuant to section 9(c) of the Consumer Product Safety Act, publication of a proposed rule must include a preliminary regulatory analysis containing the following:

- (1) a preliminary description of the potential benefits and costs of the proposed rule, including any benefits or costs that cannot be quantified in monetary terms, and an identification of those likely to receive the benefits and bear the costs;
- (2) a discussion of the reasons why a standard submitted to the Commission was not published as the proposed rule;
- (3) a discussion of why efforts submitted to the Commission to modify or develop a relevant voluntary safety standard would not be likely to eliminate or adequately reduce the risk of injury addressed by the proposed rule, in a reasonable time; and
- (4) a description of any reasonable alternatives to the proposed rule, together with a summary description of their potential costs and benefits and why such alternatives should not be published as a proposed rule.

15 U.S.C. § 2058(c).

A discussion of the first three elements follows. The fourth element is captured in Tab F.

¹⁰⁸ The small parts cylinder referenced in the draft proposed rule is specified in 16 CFR part 1501—Method for Identifying Toys and Other Articles Intended for Use by Children Under 3 Years of Age Which Present Choking, Aspiration, or Ingestion Hazards Because of Small Parts.

¹⁰⁹ The flux index (magnetic force) of a magnet is calculated by multiplying the square of the magnet’s surface flux density (in KGauss) by its maximum cross-sectional area (in mm^2).

C. Background

The CPSC has collected information regarding growing numbers of injuries with, and hazards posed by, hazardous magnets in consumer products. Detailed in the Directorate for Engineering Sciences, Division of Human Factors (ESHF) memorandum (Harsanyi, 2021, TAB C), where the type of product was indicated in incident reports, the majority of magnet ingestion incidents involved magnets used for amusement or jewelry at the time of ingestion, including from products that do not fall under the toy standard. Many of these ingestions resulted in surgical removal of magnets and surgical repair of injuries,¹¹⁰ and others required non-surgical medical interventions, such as emergency endoscopies and colonoscopies. Reported magnet ingestions have involved young children, who put the magnets in their mouths, and adolescents and teens who experimented with the sensation of magnets (*e.g.*, attached magnets to their braces) or paired magnets to mimic tongue-or-lip-piercings. If ingested, some magnets, as a consequence of their properties, are powerful enough to interact internally with one another through body tissue, and resist natural bodily forces to separate the magnets. Detailed in the Directorate for Health Sciences (HS) memorandum, this interaction has led to serious injuries and deaths, typically by causing intestinal twisting (volvulus injuries), fistulae, and perforations (Stabley, 2021, TAB A). In total, staff is aware of seven deaths involving the ingestion of hazardous magnets between November 24, 2005 and January 5, 2021, five of which occurred in the U.S. and two abroad.¹¹¹ Regarding the deaths in the U.S., one death involved a children's toy magnet building set, one death involved unspecified magnets, one death involved a magnet set, and two deaths involved magnets from unknown products; however, the magnets in these two unknown products were similar, if not identical, to magnets typically found in magnet sets. One of these unknown products was described as a magnet fidget toy building set, which is a common description for magnet sets. As detailed in CPSC staff's 2020 Informational Briefing Package Regarding Magnet Sets,¹¹² CPSC staff finds that the internal interaction hazard is a hidden hazard, which is unlikely to be anticipated, appreciated, and avoided by children and caregivers, and which is unlikely to be addressed effectively without performance requirements limiting the size, strength, or both, of magnets in these types of products.

CPSC published a similar rule addressing ingestion injuries involving "magnet sets" on October 3, 2014 (16 CFR part 1240), which went into effect on April 1, 2015 (79 FR 59962). Magnet sets are a subset of the subject magnet products. They are generally marketed as adult¹¹³ desk toys for amusement and often used as toys and jewelry. The 2014 rule defined "magnet set" as "aggregations of separable magnetic objects that are marketed or commonly used as a manipulative or construction item for entertainment, such as puzzle working, sculpture building, mental stimulation, or stress relief." Magnet sets account for a substantial share of the subject

¹¹⁰ ESHF reports: "At least 124 CPSRMS incidents resulted in some form of surgery (including laparoscopy, laparotomy, appendectomy, cecostomy, enterotomy, colostomy, cecectomy, gastrotomy, jejunostomy, resection, and transplant)" (Harsanyi, 2021).

¹¹¹ Two of the seven deaths occurred abroad (one in Australia in 2011 and one in Poland in 2014). Each of these deaths involved magnets from unknown products; however, the magnets were similar, if not identical, to magnets typically found in magnet sets.

¹¹² CPSC staff's informational briefing package regarding magnet sets, "Staff Briefing Package In Response to Petition CP 17-1, Requesting Rulemaking Regarding Magnet Sets," dated June 3, 2020: [https://cpsc.gov/s3fs-public/Informational Briefing Package Regarding Magnet Sets.pdf?FKVcZpHmPKWCZNb7JEl6Ir0a31WV72PI](https://cpsc.gov/s3fs-public/Informational%20Briefing%20Package%20Regarding%20Magnet%20Sets.pdf?FKVcZpHmPKWCZNb7JEl6Ir0a31WV72PI).

magnet products addressed by the current draft NPR. The 2014 rule restricted the size and strength of magnets in magnet sets manufactured or imported on or after April 1, 2015. The U.S. Court of Appeals for the Tenth Circuit vacated the rule in November 2016.

In reviewing incident data relative to the vacated rule, CPSC staff found that magnet ingestion incidents dropped markedly during the years the rule was announced and in effect, and rose markedly in the years following the year the rule was vacated. Analysis by staff of the Division of Hazard Analysis, Directorate for Epidemiology (EPHA) found that the estimated number of magnet-related ingestions treated in hospital emergency departments, which averaged 2,300 annually during 2010–2013, fell to 1,300 annually during 2014–2016. In the years since the standard was vacated by the Court, 2017–2020, estimated annual average number of ED-treated magnet ingestion injuries has increased to 2,300 (Topping, 2021, TAB B). Although EPHA excluded ingestions of magnets determined to be out of the scope of the draft proposed rule¹¹⁴ from the analysis, these estimates likely include ingestions of some magnets that are not subject magnet products, since it is not possible to determine the exact product characteristics for every known magnet ingestion. These correlational findings are consistent with national poison control center data and with CPSC staff's extensive research findings regarding known hazard patterns associated, in particular, with the subject magnet products (Stabley, 2021, TAB A; Harsanyi, 2021, TAB C).

D. Description of the Product and Market

The subject magnet products are products with one or more magnets, which are loose or separable, and designed, marketed, or intended to be used by consumers for entertainment, jewelry (including children's jewelry), mental stimulation, stress relief, or a combination of these purposes. Examples of the subject magnet products include magnet sets, other types of magnet toys marketed to users 14 years and older, and jewelry with separable magnets that can be arranged by the consumer. Jewelry with non-removable magnets, such as necklaces with magnetic clasps or "magnetic therapy" jewelry with firmly-attached magnets, would not be considered subject magnet products.

The subject magnets typically are small, powerful magnetic balls, cubes, cylinders and other shapes that can be used to create jewelry, such as necklaces, bracelets, and simulated piercings, and aggregated in many different arrangements to make sculptures and a wide variety of geometric shapes.¹¹⁵ These types of magnets are typically used in desk toy magnet sets, jewelry sets, and various other building sets, and were introduced for such purposes in 2008, but the first year with significant sales to U.S. consumers was 2009, as desk toy magnet sets. Subject magnet products have magnets with various compositions, including ferrite/hematite, such as rock-shaped magnets typically intended for amusement, which have been involved in magnet ingestion incidents, including resulting in internal interaction injuries. However, the most common compositions for the subject magnets are alloys of neodymium, iron, boron (NIB), or

¹¹⁴ Excluded magnet products were "children's toys" subject to the requirements in ASTM F963, *Standard Consumer Safety Specification for Toy Safety*, which is mandated by 16 CFR part 1250, and magnet products intended only for education and research (such as science kits) and/or home and kitchen (such as shower curtains and magnetic closures) purposes.

¹¹⁵ The great majority of magnets sold were balls, rather than cubes or other shapes.

other rare earth metals. These compositions have been confirmed in analyses of product samples by CPSC staff from the Directorate for Laboratory Sciences. The magnetized NIB cores are coated with a variety of metals and other materials to make them more attractive to consumers and to protect the brittle magnetic alloy materials from breaking, chipping, and corroding. Nearly 100 percent of neodymium and other rare earth metals are mined in China, which also reportedly holds a nearly worldwide monopoly on the production of NIB magnets (Dent, 2012). Based on available information, most, if not all of the subject magnets, and perhaps most of the finished and packaged products that would be subject to the draft proposed standard, are produced by manufacturers located in China.

Of the various magnet products covered in the draft proposed rule, magnet sets have been particularly concerning to CPSC staff, given their popularity among children and teens for amusement and jewelry, their typical inclusion of numerous, loose hazardous magnets, and their well-documented involvement in internal interaction injuries. EC has investigated magnet sets in previous CPSC staff packages, including regarding the 2014 rule on magnet sets and the 2020 informational briefing package regarding magnet sets. At this time, it appears that nearly all of the current marketers (firms or individuals) of magnet sets sell through Internet sites, rather than through “brick-and-mortar” retailers such as book stores, gift shops, and other outlets (which commonly sold magnet sets during 2009 through mid-2012).¹¹⁶ Some of these Internet sites are operated by the importers, but the great majority of sellers (in terms of distinct firms or individuals, if not unit sales) appear to sell through their stores operated on the sites of other Internet retailer platforms.

An examination of the market for magnet sets was undertaken for the CPSC late in 2018 by Industrial Economics, Incorporated (IEc). IEc’s review of magnet sets offered for sale on two major Internet platforms late in 2018 found a total of 69 sellers (IEc, 2019, p. 5). IEc also identified 10 manufacturers and two retailers.¹¹⁷ EC provided IEc with a spreadsheet of our prior research, which identified at least 121 sellers of magnet sets on the two Internet retailing platforms. IEc reviewed these sellers with the intention of merging CPSC’s research with newer information. In this review, IEc found that the great majority of sellers recorded by CPSC on one of the sites were no longer selling relevant magnet set models. Further, more than half of the sellers on the other site no longer sold relevant magnet set models. IEc’s review confirms that the leading Internet marketplaces have high turnover rates for magnet set products offered on their sites (Israel, J. & Baxter, J. (IEc), 2019, p. 8).

In 2020, EC reviewed the status of previously identified sellers of magnet sets on the leading Internet retailing platforms and found further evidence of the high turnover rates: most of the sellers identified in late 2018 had either ceased selling magnet sets, or had abandoned their stores. We found that only 9 of 69 sellers were still selling magnet sets. The remaining sellers either no longer offer magnet sets or no longer operate on the platforms. However, we did

¹¹⁶ Internet searches on February 3, 2020, found that magnet sets were being offered for sale on Internet sites operated by retailers with brick-and-mortar stores. However, a subsequent review of such sites on March 4, 2020, did not find the magnet sets were being offered for sale.

¹¹⁷ IEc classified manufacturers as firms producing and selling their own magnet set products, and retailers as firms that typically sell magnets from multiple manufacturers (IEc, 2019, p. 4).

identify 29 new sellers that were not identified by IEc as being active in the market late in 2018. This gives further evidence of the high turnover rate among retail sellers of magnet sets.

Although the locations of the sellers on major internet retailing platforms have not always been clear, many appeared to have been located in China. EC's 2018 review of the market found that about 57 percent of magnet set sellers on one platform (foreign and domestic) had their orders fulfilled by domestically-located centers. Our 2020 review found 16 current sellers on one major Internet platform, most of which appeared to have been located in China; 4 current sellers (25%) had orders fulfilled by the platform. Our 2020 review of magnet sets of interest on another major Internet retailing platform found that of 18 sellers, 13 (87%) were located in the United States.¹¹⁸ This was an apparent shift from 2018, when we found that a substantial majority of sellers (75%) on the platform were located in China or Hong Kong. Six new sellers of magnet sets were found in a recent (June & July 2021) review of the platform by EC (4 domestic and 2 in China).

In addition to the use of Internet retailers based in the United States, U.S. consumers may also purchase a wide variety of magnet sets using online retailers based in China. Magnet sets purchased from foreign Internet retailers may be shipped to U.S. consumers directly from China or from warehouse facilities located domestically.

Magnet sets currently offered for sale are comprised of spheres or cubes in a range of dimensions and numbers of individual magnets. Magnet sets seen in our review of the market mainly were comprised of 216 magnetic spheres, with diameters of 5 mm.¹¹⁹ Retail prices average under \$20 per set. IEc's market review in late 2018 had similar findings.¹²⁰ Magnet sets are also available in larger sets of 512 magnets and 1,000 or more.

Magnet sets comprised of spheres or cubes with smaller dimensions (2.5 mm to 3 mm) are also marketed, typically at lower prices. Some of these magnet sets are advertised as having magnets with magnetic flux indices less than 50 kG² mm²; below the threshold for being considered hazardous magnets. Recent testing of samples of such smaller magnets by staff of the Directorate for Laboratory Sciences (and reported in the memorandum from the Directorate for Engineering Sciences, Division of Mechanical and Combustion Engineering) found that 2.5 mm magnets typically had flux indices of less than 50 kG² mm²; however, many of the magnet sets tested failed the ASTM 963 requirements (or proposed rule) because at least one of the magnets in the set measured 50 kG² mm² or over. Sets with 3 mm diameter magnets were found to have flux indices above 50 kG² mm (Paul, 2021, TAB D).

Jewelry, and other types of adult magnet products intended for amusement, which have one or more separable/loose magnets are within the scope of the draft proposed rule; however, EC has not identified information on unit sales of these products, and invites public comment

¹¹⁸ Several stores selling magnet sets on one major Internet retailing platform appeared to have been operated by the same individuals, based on locations and prices. In these cases, multiple stores were not counted as distinct sellers.

¹¹⁹ Our 2018 review of the market found high-powered magnet sets for sale ranging from 20 or fewer spheres up to 1,728 spheres.

¹²⁰ IEc found that magnet sets with 216 magnets accounted for approximately one-third of the models in their market research, with an average price of \$16.67 (IEc, 2019, p. 7). However, sets of 216 magnets that measured 5 mm in diameter averaged \$18.62.

with such information. CPSC staff is aware of magnets previously marketed online as jewelry making sets, and currently online as fake studs/piercings, although it is unclear how many of these products contain hazardous magnets. It is clear from the incident data that many magnet ingestion cases involve the use of magnet products described as jewelry, such as bracelets and necklaces, and magnets used as jewelry (including magnet set magnets), such as mouth, cheek, and tongue piercings, at the time of the incidents. While there lacks certainty in product identification in most of the ingestion incidents, this hazard pattern is considered by CPSC staff to be foreseeable, making CPSC staff concerned regarding hazardous magnets in jewelry. Similarly, CPSC staff is aware of incidents involving children and teens accessing hazardous magnets from entertainment products belonging to adults, such as products referred to as “desk toys” and “executive toys.” CPSC staff remains concerned regarding the access and use of hazardous magnets from entertainment products owned by and/or intended for adults.

E. Preliminary Regulatory Analysis – Potential Benefits and Costs Assessment

The preliminary regulatory analysis, which contains a preliminary description of the potential benefits and costs of the draft proposed rule, is conducted from a societal perspective, considering all of the significant costs and health outcomes (Gold et al., 1996; Haddix, Teutsch, Corso & Phaedra, 2003; Neumann et al, 2016). Benefits and costs may be calculated on a per-product in-use basis, an approach that has been found useful at the CPSC (Rodgers & Rubin, 1989; Tohamy, 2006; Smith, 2016; Rodgers & Garland, 2016).

The purpose of the draft proposed rule is to prevent serious internal injuries or deaths that can result when children and teens ingest two or more of the subject magnets (or at least one magnet and another ferromagnetic object). The draft proposed rule would establish a standard for products with one or more magnets, which are loose or separable, and designed, marketed, or intended to be used by consumers for entertainment, jewelry, mental stimulation, stress relief, or a combination of these purposes (“subject magnet products”), and that are not subject to the toy standard. Such products that do not meet specified requirements would be prohibited from being sold. Therefore, the expected benefits of the draft proposed rule would be the reduction in the risk of serious injury or death from magnet ingestion and resulting elimination of the societal costs associated with the injuries involving the subject magnet products that do not comply with the requirements. And, because the rule would require that subject magnets meet the proposed standards, the costs would consist of the lost utility to consumers because they would no longer be able to purchase and use non-complying magnets (referred to as lost consumer surplus), and the lost income of producers who would no longer be able to produce and sell the subject magnets (lost producer surplus). It is possible, however, that these costs to consumers and producers would be offset by the availability of highly similar products that do comply with the proposed rule.

Reduction in Risk of Serious Injury or Death and Societal Costs

We begin by discussing the characteristics and societal costs of the injuries that involved identified subject magnet product categories—namely, magnet sets, magnet toys, and jewelry. Preventing these injuries would represent benefits of the draft proposed rule. National estimates of injuries treated in emergency departments (ED) were derived from the CPSC’s National

Electronic Injury Surveillance System (NEISS), a stratified national probability sample of U.S. hospital EDs consisting of about 100 U.S. hospitals that have at least six beds and provide 24-hour emergency service (Schroeder & Ault, 2001).

In addition to injuries initially treated in hospital EDs, many product-related injuries are treated in other medical settings, such as, physicians' offices, clinics, and ambulatory surgery centers. Some injuries also result in direct hospital admission, bypassing the hospital ED entirely. The number of subject magnet product injuries treated outside of hospital EDs is estimated with the CPSC's Injury Cost Model (ICM), which uses empirical relationships between the characteristics of injuries (diagnosis and body part) and victims (age and sex) initially treated in hospital EDs and the characteristics of those initially treated in other settings. A detailed discussion of the ICM and these methods is given in Miller et al. (2000); Bhattachara, Lawrence, Miller, Zaloshnja & Jones (2012); and Lawrence (2013).

The ICM estimate of injuries treated outside of hospitals or hospital EDs (*e.g.*, in doctors' offices, clinics, etc.) is based on data from the Medical Expenditure Panel Survey (MEPS). The MEPS is a nationally representative survey of the civilian, non-institutionalized population that quantifies individuals' use of health services and corresponding medical expenditures. It combines data from a panel of participants interviewed quarterly over a two-year time period with data from the respondents' medical providers. The MEPS is administered by the Agency for Healthcare Research and Quality (AHRQ). The ICM uses the MEPS data, in combination with a classification tree analysis technique, to project the number and characteristics of injuries treated outside of hospitals.

To project the number of direct hospital admissions which bypass hospital EDs, the ICM uses data from the Nationwide Inpatient Sample of the Healthcare Cost and Utilization Project (HCUP-NIS), which was also analyzed using a classification tree analysis technique. HCUP is a family of healthcare databases and related software tools and products developed through a federal-state-industry partnership and sponsored by AHRQ. The HCUP-NIS provides information annually on approximately 3 to 4 million in-patient stays from about 1,000 hospitals.

The classification tree analysis technique (also called decision tree) is a statistical tool that divides and sorts data into smaller and smaller groups for estimating the ED share of injuries until no further gains in predictive power can be obtained. This technique allows for more precise estimates of injuries treated in doctor visits or injuries admitted directly to the hospital than other regression techniques. For example, where data permit, the age and sex of the victim can have an influence on the estimates of the number of injuries treated outside the ED. When we combine the national estimates of the NEISS with the non-ED estimates from the ICM using classification tree techniques, we obtain total estimated medically-treated injuries.

Based on the estimate of about 2,135 magnet injuries initially treated in hospital EDs annually during 2017 through 2020, the ICM projects another 856 magnet injuries treated annually outside of hospitals (*e.g.*, in doctors' offices, clinics, etc.) and about 264 direct hospital admits annually, bypassing the ED. Combined with the ED-treated injuries, there may have been an estimated total of about 3,255 medically-treated injuries annually involving the subject magnets from 2017 through 2020.

The ICM is fully integrated with NEISS and provides estimates of the societal costs of injuries reported through NEISS, as well as the societal costs of other medically treated injuries estimated by the ICM. The major aggregated societal cost components provided by the ICM include medical costs, work losses, and the intangible costs associated with lost quality of life or pain and suffering.¹²¹

Medical costs include three categories of expenditures: (1) medical and hospital costs associated with treating the injury victim during the initial recovery period and in the long run, including the costs associated with corrective surgery, the treatment of chronic injuries, and rehabilitation services; (2) ancillary costs, such as costs for prescriptions, medical equipment, and ambulance transport; and (3) costs of health insurance claims processing. Cost estimates for these expenditure categories were derived from a number of national and state databases, including the Medical Expenditure Panel Survey, the Nationwide Inpatient Sample of the Healthcare Cost and Utilization Project (HCUP-NIS), the Nationwide Emergency Department Sample (NEDS), the National Nursing Home Survey (NNHS), MarketScan® claims data, and a variety of other federal, state, and private databases.

Work loss estimates are intended to include: (1) the forgone earnings of the victim, including lost wage work and household work, (2) the forgone earnings of parents and visitors, including lost wage work and household work, (3) imputed long term work losses of the victim that would be associated with permanent impairment, and (4) employer productivity losses, such as the costs incurred when employers spend time juggling schedules or training replacement workers. Estimates are based on information from the Nationwide Inpatient Sample of the Healthcare Cost and Utilization Project (HCUP-NIS), the Nationwide Emergency Department Sample (NEDS), Detailed Claims Information (a workers' compensation database), the National Health Interview Survey, U.S. Bureau of Labor Statistics, and other sources.

The intangible, or non-economic, costs of injury reflect the physical and emotional trauma of injury as well as the mental anguish of victims and caregivers. Intangible costs are difficult to quantify because they do not represent products or resources traded in the marketplace. Nevertheless, they typically represent the largest component of injury cost and need to be accounted for in any benefit-cost analysis involving health outcomes (Rice et al., 1989; Haddix, Teutsch and Corso, 2003; Cohen and Miller, 2003; Neumann et al, 2016). The ICM develops a monetary estimate of these intangible costs from jury awards for pain and suffering. While these awards can vary widely on a case-by-case basis, studies have shown them to be systematically related to a number of factors, including economic losses, the type and severity of injury, and the age of the victim (Viscusi, 1988; Rodgers, 1993; Cohen and Miller, 2003). Estimates for the ICM were derived from regression analysis of jury awards in nonfatal product liability cases involving consumer products compiled by Jury Verdicts Research, Inc.

Table 1 below provides *annual* estimates of the injuries and the societal costs associated with ingestions of subject magnets identified as “magnet sets,” “magnet toy,” or “jewelry.” EPHA staff combined these identified categories under the group name “Amusement/Jewelry.”

¹²¹A detailed description of the cost components, the general methodology and data sources used to develop the CPSC’s Injury Cost Model, and Injury Cost Model Updates, can be found in Miller et al. (2000); Lawrence (2008, 2013, 2014, 2015a, 2015b, 2015c); Lawrence et al. (2018); and Bhattachara, et al. (2012).

“Jewelry” includes cases of uncertain product classification for which the magnets were described as jewelry. See the hazard data analysis by EPHA staff for details on these categories (Topping, 2021; Tab B).

As shown in Table 1, the 2017 through 2020 NEISS estimates suggest an estimated *annual* average of about 437 ED-treated injuries, comprised of 278 injuries that were treated and released and 159 injuries that required hospitalization. Additionally, based on estimates from the ICM, 164 injuries were treated outside of hospitals annually and another 77 injuries resulted in direct hospital admission.

Based on ICM estimates, these injuries resulted in annual societal costs of about \$47.6 million (in 2018 dollars) during the 2017 through 2020 time period. The average estimated societal cost per injury was about \$13,000 for injuries treated in physician’s offices, clinics, and other non-hospital settings; about \$22,000 for injuries that were treated and released from EDs; and about \$166,000 for injuries that required admission to the hospital for treatment. Medical costs and work losses (including work losses of caregivers) accounted for about 44 percent of these injury cost estimates, and the less tangible costs of injury associated with pain and suffering accounted for about 56 percent of the estimated injury costs.

Table 1.
Estimated average annual medically treated injuries and associated societal costs for magnet ingestions for which identifying product information was reported (i.e., magnets from magnet sets, magnet toys, or jewelry) 2017 – 2020.

Injury Disposition	Estimated Number	Estimated Societal Costs (\$ millions)*
Doctor / Clinic	164	\$ 2.2
Treated and Released from Hospital Emergency Department (ED)	278	\$ 6.2
Admitted to Hospital Through the ED (NEISS)	159†	\$ 26.4
Direct Hospital Admissions, bypassing the ED	77	\$12.8
Total Medically Attended Injuries	678	\$47.6

* In 2018 dollars.

† According to the Directorate for Epidemiology, the estimated number of hospital-admitted, emergency department-treated injuries is not a reliable estimate because of the small number of cases upon which the estimate was based.

Uncertainty Regarding the Injury Data. In addition to the magnet cases upon which Table 1 was based, for which identifying information was reported (*i.e.*, magnets from magnet sets, magnet toys, or jewelry), there were also 322 NEISS cases during 2017 through 2020 (representing about 1,873 ED-treated injuries annually), in which the magnet type was classified as “unidentified.” These cases included narratives that mentioned that at least one magnet was ingested, but presented insufficient information to classify the magnet product type. Based on analysis of the data, and the trends in magnet-related incidents relative to the vacated rule on magnet sets, staff finds it reasonable to conclude that the “unidentified” magnet products most likely involved magnets considered within scope of the draft proposed rule; that is, intended for amusement and/or jewelry (Harsanyi, 2021, Tab C). Based on ICM estimates for unidentified magnet products involved in ingestion injuries, average annual societal costs for 2017 – 2020 totaled \$151.8 million. Consequently, to the extent that the unidentified magnet products were products that would be covered by the draft proposed rule, the Table 1 results could substantially understate the societal costs associated with the magnet products subject to the draft proposed rule.

Estimated Benefits

As noted above, the benefits of the magnet rule would be the reduction in the risk of serious injury or death from magnet ingestion and the resulting value of the societal costs of the injuries that would be prevented. Because the rule would require that subject magnet products meet the requirements of the proposed rule, injuries that would have occurred in the absence of a rule would be prevented. Staff is aware of seven deaths involving the ingestion of hazardous magnets, five of which occurred in the U.S. One death in the U.S. involved a magnet set, and two deaths in the U.S. involved magnets similar, if not identical, to magnets typically found in magnet sets. One of these unknown products was described as a magnet fidget toy building set, which is a common description for magnet sets. Thus, we anticipate that the rule would effectively reduce the likelihood of future fatalities as well as injuries.

The annual expected benefits of the rule depend upon the exposure to risk associated with the subject magnet products, as well as the estimated societal costs described in Table 1. Although many of the subject magnet products retain much of their magnetism for many years, it is likely that many are discarded well before that time. The actual expected product life of the subject magnet products is uncertain; for this analysis we present a range of potential benefit estimates under an assumed product life of one-and-one-half, two, and three years. Table 2 presents benefit estimates under the alternative product life assumptions (line (b)). Line (a) shows average annual aggregate societal costs, from Table 1.

Table 2.
Present Value of Societal Costs per Subject Magnet Product in Use (or Gross Benefits of a Rule), for Various Expected Product Lives during the 2017 through 2020 time period

(a) Aggregate Annual Societal Costs (millions \$)	\$47.6	\$47.6	\$47.6
(b) Expected Useful Product Life (years)	1.5	2	3
(c) Magnet Products in Use, Average Annual	444,000	545,000	701,000
(d) Annual Societal Costs per Subject Magnet Product [(a) ÷ (c)]	\$107	\$87	\$68
(e) Present Value of Societal Costs, per Subject Magnet Product (3% Discount Rate)	\$160	\$171	\$190
(f) Present Value of Societal Costs, per Subject Magnet Product (7% Discount Rate)	\$154	\$162	\$178

Line (c) presents the average annual estimated number of subject magnet products in use during the 2017 through 2020 time period, based on producer-reported annual magnet set sales collected by the Office of Compliance and Field Operations up through mid-2012 and assumptions of annual sales of all subject magnet products through 2020 (including an assumption of 500,000 units per year for 2018 - 2020), an assumed expected product life of one-and-one-half, two, and three years (line b), and the application of the CPSC's Product Population Model, a computer algorithm that projects the number of products in use given estimates of annual product sales and product failure rates (Lahr and Gordon, 1980). Staff welcomes comments with information on annual sales and expected product life of magnet products subject to the draft rule.

Figure 1 shows changes in the estimated number of subject magnet products in use over time, from 2009 through 2020.

The annual estimated societal costs per subject magnet product in use (line d of Table 2) are presented as the quotient of the annual societal costs (line a), per product in use, and the estimated average number of products in use (line c).

Based on these estimates, and an assumed average product life ranging from 1.5 to 3 years, the present value of societal costs, per subject magnet product, range from about \$160 to about \$190 using a 3 percent discount rate (line e), or from about \$154 to \$178 using a 7 percent discount rate (line f).

Because the rule would prohibit the sale of the magnets identified as hazardous, the first order estimate of benefits would be equal to the present value of societal costs, presented in lines (e) and (f) and would range from about \$154 (with a 1.5-year product life and a 7 percent discount rate) to \$190 (with a 3-year product life and a 3 percent discount rate) per product. Some consumers of non-complying products might purchase products that serve similar

purposes. To the extent that these substitute products are associated with some risk of injury, even though reduced, the overall benefits of the rule would be reduced. Hence, the overall benefits of the rule could be reduced by some unknown amount and would be measured as *the net* reduction in injuries and the concomitant reduction in societal costs that would result.

Figure 1.

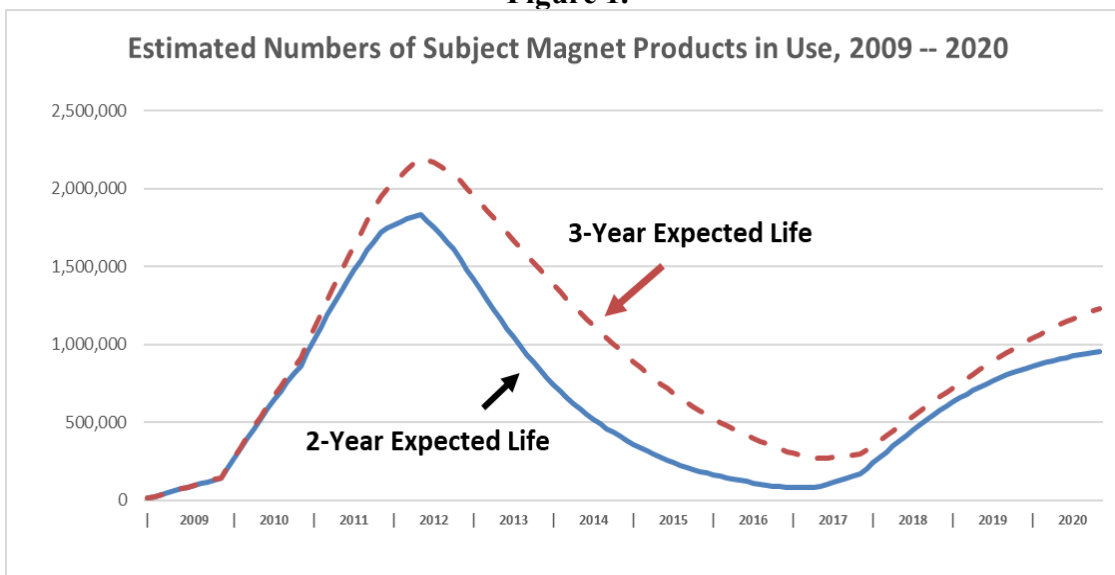

Estimated Costs of the Draft Proposed Rule

Both consumers and producers benefit from the production and sale of consumer products. The consuming public obtains the use value or utility associated with the consumption of products; producers obtain income and profits from the production and sale of products. Consequently, the costs of requiring that magnet products comply with the proposed rule would consist of: (1) the lost use value experienced by consumers who would no longer be able to purchase magnets that do not meet the standard at any price; and (2) the lost income and profits to firms that could not produce and sell non-complying products in the future.

Both consumer and producer surplus depend upon, among other things, product sales. However, unit sales of subject magnet products are unknown. Therefore, we will consider possible costs associated with several estimates of sales, ranging from about 250,000 to 1 million subject magnet products per year. For purposes of exposition, the immediate discussion below assumes annual sales of 500,000 per year.

Lost Utility to Consumers. First consider the lost utility to consumers. In the case of magnet sets, which likely comprise the vast majority of subject magnet products on the market and involved in magnet ingestion incidents, previous public comments by sellers and consumers cite usefulness of the magnets as a manipulative or construction item for entertainment, such as puzzle working, sculpture building, mental stimulation, or stress relief. Others have claimed that the magnets can have beneficial therapeutic value for children with ADHD. In addition to consumer uses promoted by sellers, and reported in comments by consumers, ESHF notes that use of magnets from magnet sets as jewelry is a common hazard pattern. The individual magnets

might also have additional uses, apart from those for which they are intended (e.g., using magnets from a magnet set on a refrigerator). Thus, we may conclude that consumers derive utility from magnet sets and other subject magnet products from a wide variety of uses, even those not promoted by sellers. However, there would presumably be little lost utility for these unintended product uses since products intended for those purposes (e.g., refrigerator magnets) would be unaffected by the draft proposed rule.

We cannot estimate in any precise way the use value that consumers receive from these products, but we can describe use value conceptually. In general, use value includes the amount of: (1) consumer expenditures for the product, plus (2) what is called “consumer surplus.” Assuming annual sales of about 500,000 subject magnet products annually, and assuming an average retail price of about \$20 (based on price data for magnet sets), consumer expenditures would amount to about \$10 million annually. These expenditures represent the minimum value that consumers would expect to get from these products. It is represented by the area of the rectangle OBDE in the standard supply and demand graph below (Figure 2), where B equals \$20, and E equals 500,000 units.

Figure 2.
Supply and demand graph illustrating the concepts of consumer and producer surplus

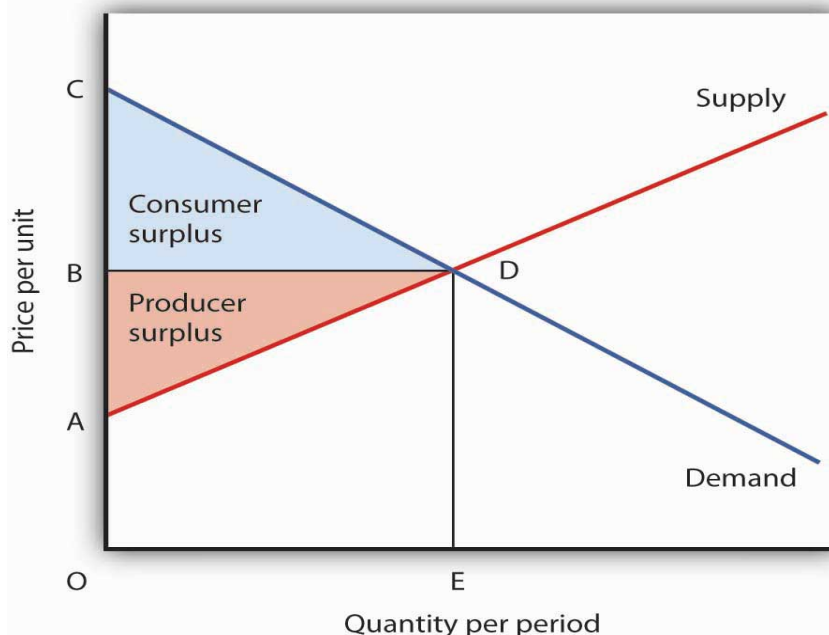

Consumer surplus is given by the area of the triangle BCD under the graph’s demand function, and represents the difference between the market-clearing price and the maximum amount consumers would have been willing to pay for the product. This consumer surplus will vary for individual consumers, but it represents a benefit to consumers over and above what they

had to pay (McCloskey, 1982).¹²² For example, although tickets to a concert or football game might sell for \$100 each, some consumers who buy them for \$100 would have been willing to pay \$150 per ticket. In other words, they paid \$100 and received benefits that they value at \$150. Hence, each of these consumers would receive a *consumer surplus* of \$50.¹²³

In general, the use value of the subject magnet products obtained by consumers is represented by the area of the trapezoid OCDE. However, the prospective *loss* in use value associated with the draft proposed rule, which would require that products comply with the rule, would amount to, at most, the area of the triangle representing the consumer surplus. This is because consumers would no longer be able to obtain utility from the prohibited product, but they would, nevertheless, still have the \$10 million (represented by the rectangle OBDE) that they would have spent on non-complying subject magnet products in the absence of a rule. Although consumers would no longer be able to purchase magnet products that do not comply with the draft proposed rule, which would have been their preferred choice, they can use this money to buy other products providing use-value. This ability to purchase alternative complying products could reduce the net loss in consumer surplus resulting from the draft rule.

We have no information regarding aggregate consumer surplus; and hence, the amount of utility that would be lost as a result of the draft proposed magnet rule. However, if, for example, consumers who purchased the non-complying subject magnet products at an average price of \$20 would have been willing to spend, on average, \$35 to \$45 per product (*i.e.*, an additional \$15 to \$25 per set), the lost utility might amount to about \$7.5 million (*i.e.*, [$\$35-\20] \times 500,000 units annually) to \$12.5 million (*i.e.*, [$\$45-\20] \times 500,000 units annually) on an annual basis.

Finally, we note that the loss in consumer surplus just described represents the maximum loss of consumer utility from a draft proposed rule. This is because consumers are likely to gain some amount of consumer surplus from products that are purchased as an alternative to those subject magnet products that would no longer be available because of the rule. If, for example, there were close substitutes (*e.g.*, products that are almost as satisfying and similarly priced) for the subject magnet products that do not meet the standard, the overall loss in consumer surplus (and, hence, the costs of the draft proposed rule) would probably tend to be small. On the other hand, if there are no close substitutes, the costs of the rule would tend to be higher.

Staff is aware of magnet sets advertised as having magnets with a magnetic flux index less than 50 kG² mm² (compliant with the draft proposed rule), which are marketed for the same purposes as the more common hazardous magnet sets. As noted above, CPSC staff has found through recent testing of 2.5 mm diameter magnets from magnet sets that many of the magnets measured less than 50 kG² mm², although many of the magnet sets failed the ASTM 963 requirements (or proposed rule) because at least one of the magnets in the set exceeded that flux index. Regarding magnet sets and other toys subject to the draft proposed rule, there are

¹²² The concept of consumer surplus is discussed in OMB's Circular A-4 (OMB, 2003) and has been applied in a number of staff analyses, including Tohamy (2006); Smith (2016); and Zamula, Rodgers & Bailey (2016).

¹²³ If the above graph represents the market for tickets, the demand curve describes the quantity of tickets demanded at each price (*i.e.*, the quantity of tickets consumers are willing and able to purchase at each price). In this example, the \$150 that the consumer would have been willing to pay for the ticket is represented on the demand curve at a point to the left of point D. The consumer surplus is given by the relevant point on the demand curve (*i.e.*, where price = \$150), minus the market clearing price of \$100.

alternative products with similar functions for amusement and stress relief, such as magnetic desk sculptures which use a magnetic base (not a “small part”) and ferromagnetic pieces, sets of large magnetic balls, and a wide variety of “fidget toys.”

Manufacturers of magnetic jewelry with loose or separable magnets have options for complying with the rule, including using magnets that are not hazardous, or close substitutes that are nonmagnetic. If jewelry manufacturers wish to offer separable pieces on necklaces or bracelets, they might offer nonmagnetic pieces that attach to a bracelet or necklace incorporating attached magnets. Additionally, magnetic stud earrings and faux piercing jewelry have clip-on alternatives and pierced jewelry as substitutes.

Regardless of the availability of product alternatives for the many uses consumers find for magnet sets and other subject magnet products, the draft proposed rule will result in some level of lost utility. Consumer purchases of subject magnet products that exceed the size or strength requirements in the draft proposed rule suggests that some consumers may prefer these products over compliant versions of the products (*e.g.*, they prefer higher strength or smaller magnets); for such consumers, compliant versions may provide less utility.

Lost Benefits to Producers. The lost benefits to firms that could result from the proposed rule are measured by a loss in what is called *producer surplus*. Producer surplus is a profit measure that is somewhat analogous to consumer surplus. Whereas consumer surplus is a measure of benefits received by individuals who consume products, net of the cost of purchasing the products, producer surplus is a measure of the benefits accruing to firms that produce and sell products, net of the costs of producing them. More formally, “producer surplus” is defined as the total revenue (TR) of firms selling the magnets, less the total variable costs (TVC) of production. Variable costs are costs that vary with the level of output and usually include expenditures for raw materials, wages, distribution of the product, and the like.

In Figure 2, total revenue is given by the area OBDE, which is simply the product of sales and price. The total variable costs of production are given by the area under the supply function, OADE. Consequently, producer surplus is given by the triangle ABD, which is the area under the market clearing price and above the supply function. Note that this represents the maximum loss to producers; if there were product alternatives that were similar to the subject magnets that suppliers could produce and sell, the lost producer surplus could be less.

Following our example above, if sales of the subject magnet products average roughly 500,000 units annually, with an average retail price of about \$20 per product total industry revenues have averaged about \$10 million annually (*i.e.*, 500,000 units × \$20 per product). Information provided by magnet set sellers to the Office of Compliance and Field Operations suggested that the average import cost of magnet sets to U.S. importers, a major variable cost, may amount to about \$10 per set, or an average of about \$5 million annually (*i.e.* 500,000 sets × \$10 import cost per set). Apart from the import costs of the magnets the variable costs of production are probably relatively small. Because magnet sets are often packaged and shipped from China and sometimes sent directly to the importers point of sale, U.S. labor costs may be low; and because the magnets sets are small, storage costs are probably low. If, for example, the variable costs of production account for about half of the difference between total revenues (\$10

million) and import costs (\$5 million), producer surplus would amount to about \$2.5 million (*i.e.*, (\$10 million – \$5 million) ÷ 2) annually. At most, the lost producer surplus would amount to about \$5 million annually, if there were no variable costs other than the costs of importing the magnets (*i.e.*, total revenue of \$10 million for 500,000 units annually less the import costs of about \$5 million). While this information is specifically related to magnet sets, a similar relationship could apply to other subject magnet products affected by the draft standard. We note that manufacturers and importers might be able to respond to the rule by measures such as marketing or incorporating magnets that comply with the rule or increased marketing of products that do not have loose or separable magnets. Such measures could partially offset losses in producer surplus resulting from firms’ inability to continue marketing noncomplying magnet products.

As noted above, actual sales levels of non-complying subject magnet products are unknown. Additionally, we have no hard estimates of either consumer surplus or producer surplus. Table 3 below provides rough estimates of the possible costs of the rule, for various hypothetical sales levels ranging from 250,000 to 1 million products annually. The cost estimates are based on a number of assumptions described above, and are made for illustrative purposes. Nevertheless, because the range of sales is wide, and is likely to include actual sales levels on an annual basis, it does not appear unreasonable to assume that the costs of the draft proposed rule could range from \$5 to \$8.75 million (if sales amount to about 250,000 products annually), to about \$20 to \$35 million (if sales amount to about 1 million products annually). As noted above, these costs could be partially offset by increased marketing of products that incorporate complying magnets, or products that do not include loose or separable magnets.

Table 3.
Possible Costs of the Draft Proposed Rule,
for Various Levels of Non-Complying Subject Magnet Product Sales

Magnet Product Sales (annually)	Consumer Surplus (millions \$)	Producer Surplus (millions \$)	Total Costs (millions \$)
250,000	\$3.75 to \$6.25	\$1.25 to \$2.5	\$5 to \$8.75
500,000	\$7.5 to \$12.5	\$2.5 to \$5	\$10 to \$17.5
750,000	\$11.25 to \$18.75	\$3.75 to \$7.5	\$15 to \$26.25
1,000,000	\$15 to \$25	\$5 to \$10	\$20 to \$35

In addition to lost producer surplus, manufacturers/importers of subject magnet products that comply with the rule would likely incur some additional costs to certify that their products meet the requirements as required by Section 14 of the CPSA. The certification must be based on a test of each product or a reasonable testing program. The costs of the testing might be minimal, especially for manufacturers that currently have product testing done for products subject to the requirements in ASTM F963, *Standard Consumer Safety Specification for Toy Safety*, which is mandated by 16 CFR part 1250. Importers may also rely upon testing completed by other parties, such as their foreign suppliers, if those tests provide sufficient information for

the manufacturers or importers to certify that the magnets in their products comply with the draft proposed rule. As noted above, for subject magnet products that could be considered to be children's products, such as children's jewelry, the certification must be based on testing by an accredited third-party conformity assessment body, at somewhat higher costs.

III. Summary of Preliminary Regulatory Analysis Results

(1) a preliminary description of the potential benefits and costs of the proposed rule,

Estimated aggregate annual societal costs from ingestion injuries involving subject magnet products for 2017 through 2020 totaled \$47.6 million. Assumptions about annual product sales and expected product life of one-and-one-half, two, and three years yields estimated numbers of products in use during those years ranging from 444,000 to 701,000. The estimated present value of societal costs per subject magnet product (at a 3% discount rate) ranges from \$160 per unit (at a 1.5-year expected life) to \$190 per unit (at a 3-year expected life). On the cost side, estimates of consumer and producer surplus were uncertain, but might range from about \$5-\$8.75 million to about \$20-\$35 million, based on unit sales ranging from 250,000 to 1 million.

For illustrative purposes, if we consider annual unit sales of non-complying subject magnet products of 500,000, expected aggregate benefits could total \$80 to \$95 million annually; costs (lost consumer and producer surplus) could range from \$10 million to \$17.5 million annually. Thus, although both the benefits and costs of the draft proposed rule are uncertain, based on a range of assumptions, our estimates suggest that the potential benefits of the draft proposed rule may easily exceed the potential costs. Furthermore, as noted above, the estimated benefits exclude cases involving unidentified magnet products; therefore, to the extent that the unidentified magnet products were products that would be covered by the draft proposed rule, the benefits may be substantially greater.

(2) a discussion of the reasons why a standard submitted to the Commission was not published as the proposed rule;

In the case of consumer products with loose or separable magnets that are intended for amusement or jewelry, no standard was submitted to the Commission for consideration as a potential mandatory safety standard.

(3) a discussion of why efforts submitted to the Commission to modify or develop a relevant voluntary safety standard would not be likely to eliminate or adequately reduce the risk of injury addressed by the proposed rule, in a reasonable time;

CPSC did not receive any submissions of efforts to develop or modify a standard. Nevertheless, staff considered existing standards that address the magnet ingestion hazard to determine whether they are likely to adequately reduce the risk of injury. Analyses by ESHF and ESMC, found in Tabs C and D of the NPR briefing package, detail staff's assessment of existing domestic standards pertaining to hazardous magnets in consumer products. These standards include one voluntary standard that has been adopted as a mandatory standard and three

additional voluntary standards. Below, staff briefly summarizes the standards and staff's assessment of the standards.

ASTM F963 – 17, *Standard Consumer Safety Specification for Toy Safety*, is a mandatory standard (16 CFR part 1250), which includes performance and safety messaging requirements for objects designed, manufactured, or marketed as a plaything for children under 14 years of age. This standard identifies magnets and magnetic components as hazardous if they fit entirely within the small parts cylinder specified in the standard and have a flux index of $50 \text{ kG}^2 \text{ mm}^2$ or higher.

ASTM F2923 – 20, *Standard Specification for Consumer Product Safety for Children's Jewelry*, is a voluntary standard, which includes performance and safety messaging requirements for jewelry designed or intended primarily for children 12 years of age or younger. This standard refers to ASTM F963 for the identification of magnets and magnetic components as hazardous. This standard requires that children's jewelry shall not have an as-received hazardous magnet or hazardous magnetic component, nor liberate a hazardous magnet or hazardous magnetic component, per testing specified in ASTM F963, with the exemption of children's jewelry intended for children 8 years of age or older consisting of earrings, brooches, necklaces, or bracelets. These products with hazardous magnets, as well as their instructions, if any, shall include specified warnings.

ASTM F2999 – 19, *Standard Consumer Safety Specification for Adult Jewelry*, is a voluntary standard, which includes safety messaging recommendations for jewelry designed or intended primarily for use by consumers over age 12. This standard identifies a magnet as hazardous if it has a flux index *greater than* 50 as measured by the method described in ASTM F963. This standard recommends that adult jewelry containing hazardous magnets as received *should* include a specified warning.

ASTM F3458 – 21, *Standard Specification for Marketing, Packaging, and Labeling Adult Magnet Sets Containing Small, Loose, Powerful Magnets (with a Flux Index $\geq 50 \text{ kG}^2 \text{ mm}^2$)*, is a voluntary standard, which includes marketing, packaging, labeling, and warning requirements for adult magnet sets with hazardous magnets, which the standard describes as intended for persons 14 years of age and older. The standard identifies hazardous magnets consistent with ASTM F963.

Based on the existing data, staff supports the performance requirements for hazardous magnets specified in ASTM F963, and referenced in the other standards, for the full scope of products included in the draft proposed rule. Staff determined that none of the voluntary standards considered adequately address the risks of serious injuries because of limits in their scope of covered products and/or reliance on packaging, labeling, and warning requirements.

(4) a description of any reasonable alternatives to the proposed rule, together with a summary description of their potential costs and benefits and why such alternatives should not be published as a proposed rule.

Staff considered various alternative options to reduce the risk of the internal interaction hazard, including safety messaging and special packaging, which are used in ASTM F3458 for adult magnet sets, aversive agents to deter ingestion, future ASTM activities, and performance requirements. ESHF evaluated the potential effectiveness of safety messaging, special packaging, and the use of aversive agents as means to reduce the risks of ingestions of hazardous magnets. Detailed in Tab C of the NPR briefing package, ESHF finds that these alternatives, without performance requirements for magnets themselves, are not likely to adequately reduce the risk of injury associated with magnet ingestions. These alternatives, as well as the potential costs and benefits associated with them, are discussed in detail in the Initial Regulatory Flexibility Analysis (Smith, 2021, Tab F).

IV. References

- Bhattachara, S., Lawrence, B., Miller, T.R, Zaloshnja, E., Jones, P.R. (2012). Ratios for Computing Medically Treated Injury Incidence and Its Standard Error from NEISS Data (Contract CPSC-D-05-0006, Task Order 8). Calverton, MD: Pacific Institute for Research and Evaluation, (Aug 2012).
- Cohen, Mark A. & Miller, Ted R. (2003). "Willingness to award" nonmonetary damages and implied value of life from jury awards. *International Journal of Law and Economics*, 23, 165-184.
- Gold, Marthe R., Siegel, Joanna E., Russell, Louise B., Weinstein, Milton C., 1996. *Cost-effectiveness in health and medicine*. New York: Oxford University Press.
- Haddix, A.C., Teutsch, S.M., Corso, P.S. (2003). *Prevention effectiveness: A guide to decision and economic evaluation* (2nd ed.). New York: Oxford University Press.
- Harsanyi, S. (2021, August). Staff Analysis Report: Human Factors Assessment of Hazardous Magnet Products. Directorate for Engineering Sciences, Division of Human Factors (ESHF), CPSC. Bethesda, MD. (TAB C in the NPR briefing package)
- Israel, J., Cahill, A., and Baxter, J. (2019). Report: Final high-powered magnet set market research report. Cambridge, MA: Industrial Economics, Incorporated (IEc).
- Lawrence, Bruce, 2008. Impact of alternative discount rates on injury cost model estimates (Contract CPSC-D-05-0006, Task Order 7). Calverton, MD: Pacific Institute for Research and Evaluation (November 2008).
- Lawrence, Bruce, 2013. Revised Incidence Estimates for Non-Fatal, Non-Hospitalized Consumer Product Injuries Treated Outside Emergency Departments (Contract CPSC-D-89-09-0003, Task Order 2). Calverton, MD: Pacific Institute for Research and Evaluation (April 2013).
- Lawrence, Bruce, 2014. Updated price indexes for the Injury Cost Model (Contract CPSC-D-0003, Task Order 3, Subtask 4). Calverton, MD: Pacific Institute for Research and Evaluation (August 2015).
- Lawrence, Bruce, 2015a. Update medical costs for ED-treated injuries (Contract CPSC-D-0003, Task Order 3, Subtask 1). Calverton, MD: Pacific Institute for Research and Evaluation (January 2015)
- Lawrence, Bruce, 2015b. Update medical costs hospital-admitted injuries (Contract CPSC-D-0003, Task Order 3, Subtask 2). Calverton, MD: Pacific Institute for Research and Evaluation (January 2015)

- Lawrence, Bruce, 2015c. Updated survival probabilities for the Injury Cost Model (Contract CPSC-D-0003, Task Order 3, Subtask 3). Calverton, MD: Pacific Institute for Research and Evaluation (August 2015).
- Lawrence, B.A., Miller, T.R., Waejrer, G.M., Spicer, R.S., Cohen, M.A., Zamula, W.W. (2018). The Consumer Product Safety Commission's Revised Injury Cost Model. Maryland: Pacific Institute for Research and Evaluation (PIRE). (February, 2018).
- Miller et al. (2000). The Consumer Product Safety Commission revised injury cost model. Calverton, MD: Public Services Research Institute.
- Neumann, P.J., Sanders, G.D., Russell, L.B., Siegel, J.E., Ganiats, T.G. (2016). Cost-effectiveness in health and medicine: Second Edition. New York: Oxford University Press.
- Paul, C. (2021). Staff Analysis Report: Recommended Performance Requirements to Address Ingestion Injuries Associated with Hazardous Magnets. Directorate for Engineering Sciences, Division of Mechanical and Combustion Engineering (ESMC), CPSC. Bethesda, MD. (TAB D in the NPR briefing package)
- Rice, Dorothy P., MacKenzie, Ellen J., and Associates (1989). Cost of injury in the United States: A report to Congress. San Francisco, CA: Institute for Health & Aging, University of California and Injury Prevention Center, The Johns Hopkins University.
- Rodgers, Gregory B. (1993). Estimating jury compensation for pain and suffering in product liability cases involving nonfatal personal injury. *Journal of Forensic Economics* 6(3), 251-262.
- Rodgers, Gregory B., Garland, Sarah E. (2016). An economic analysis of requirements to prevent handheld hair dryer immersion electrocutions in the USA. *Journal of Consumer Policy*, 39, 223-240.
- Rodgers, Gregory B., Rubin, Paul H. (1989). Cost-benefit analysis of all-terrain vehicles at the CPSC. *Risk Analysis*, 9(1), 63-69.
- Schroeder, Tom, and Ault, Kimberly (2001). The NEISS sample (design and implementation) 1997 to present. Bethesda, MD: U.S. Consumer product Safety Commission. Available at: <http://www.cpsc.gov/PageFiles/106617/2001d011-6b6.pdf>.
- Smith, C. (2016, September). Draft Proposed Rule Establishing a Safety Standard for Portable Generators: Preliminary Regulatory Analysis, U.S. Consumer Product Safety Commission, Bethesda, MD.
- Smith, C. (2021, July). Staff Analysis Report: Initial regulatory flexibility analysis of a mandatory rule that would establish a standard for hazardous magnet products. Directorate for Economic Analysis (EC), CPSC. Bethesda, MD. (TAB F in the NPR briefing package)

Stabley, J. (2021, July 20). Staff Analysis Report: Health outcomes following exposure to hazardous magnets and associated medical considerations. Directorate for Health Sciences, Division of Pharmacology and Physiology Assessment), CPSC. Bethesda, MD. (TAB A in the NPR briefing package)

Tohamy, S. (2006). Final regulatory analysis of staff's draft final standard to address open-flame ignitions of mattress sets. (January 10, 2006). Bethesda, MD: U.S. Consumer Product Safety Commission.

Topping, J. (2021, July23). Staff Analysis Report: NEISS injury estimates and analysis of reported incidents related to ingestion of magnets. Directorate for Epidemiology, Division of Hazard Analysis (EPHA), CPSC. Bethesda, MD. (TAB B in the NPR briefing package)

Viscusi, W. Kip (1988). The determinants of the disposition of product liability cases: Systematic compensation or capricious awards? *International Review of Law and Economics*, 8, 203-220.

**TAB F: Initial Regulatory Flexibility Analysis of a Mandatory Rule that
Would Establish a Standard for Hazardous Magnet Products**



UNITED STATES
CONSUMER PRODUCT SAFETY COMMISSION
BETHESDA, MARYLAND 20814

Memorandum

September 12, 2021

TO: Stephen Harsanyi, Hazardous Magnet Products Project Manager
Directorate for Engineering Sciences

THROUGH: Robert L. Franklin, Acting Associate Executive Director
Directorate for Economic Analysis

FROM: Charles L. Smith, Economist, Directorate for Economic Analysis

SUBJECT: Initial Regulatory Flexibility Analysis of a Mandatory Rule that Would
Establish a Standard for Hazardous Magnet Products

I. Introduction

Continuing concern with magnet ingestion-related injuries led the Consumer Product Safety Commission (Commission or CPSC) to designate the development of a Notice of Proposed Rulemaking (NPR) addressing the hazard a priority activity of the Commission in FY 2021. In this briefing package, CPSC staff recommends that the Commission mandate performance requirements to address the internal interaction hazard associated with the ingestion of small, powerful magnets (“hazardous magnets”) by children and teens. Hazardous magnets are small enough to be swallowed by young children and strong enough to attract through body tissues, posing risks of death and serious harm.

The Regulatory Flexibility Act (RFA; 5 U.S.C. §§ 601-612) requires that rules proposed by the Commission be reviewed for the potential economic impact on small entities, including small businesses. Section 603 of the RFA requires the Commission to prepare and make available for public comment an initial regulatory flexibility analysis (IRFA) describing the impact of the proposed rule on small entities and identifying impact-reducing alternatives, unless the agency has a factual basis for certifying that the proposed rule “will not have a significant economic impact on a substantial number of small entities.”¹²⁴ Although all manufacturers or importers of subject magnet products are small businesses, relatively few are believed to focus on sales of subject magnet products. However, because the number of small firms that could be significantly impacted by the draft proposed rule is uncertain, CPSC staff has prepared an initial regulatory flexibility analysis of the draft proposed rule.

¹²⁴ 5 USC § 605 (b) of The Regulatory Flexibility Act of 1980, as amended. Available at <https://www.sba.gov/advocacy/regulatory-flexibility-act>.

The IRFA must describe the impact of the proposed rule on small entities and contain the following information:

- 1) a description of the reasons why the action is being considered;
- 2) a succinct statement of the objectives of, and legal basis for, the proposed rule;
- 3) a description of and, where feasible, an estimate of the number of small entities to which the proposed rule will apply;
- 4) a description of the projected reporting, recordkeeping, and other compliance requirements of the proposed rule, including an estimate of the classes of small entities which will be subject to the requirement and the types of professional skills necessary for the preparation of the report or record; and
- 5) an identification, to the extent possible, of all relevant Federal rules which may duplicate, overlap, or conflict with the proposed rule.

In addition, the IRFA must contain a description of any significant alternatives to the proposed rule that would minimize any significant economic impact of the proposed rule on small entities.

II. Discussion

A. Description of the Draft Proposed Rule

The draft proposed rule would establish mandatory performance requirements for products with one or more magnets, which are loose or separable, and designed, marketed, or intended, to be used by consumers for entertainment, jewelry (including children's jewelry), mental stimulation, stress relief, or a combination of these purposes ("subject magnet products"). The subject magnet products do not include "children's toys" subject to the requirements in ASTM F963, *Standard Consumer Safety Specification for Toy Safety*, which is mandated by 16 CFR part 1250. "Children's toys" are objects that are designed, manufactured, or marketed as playthings for children under 14 years old. Under the draft proposed rule, subject magnet products would comply with the standard if one of the following is met: (1) the individual magnets are too large to fit entirely within the CPSC's small parts cylinder;¹²⁵ or (2) the individual magnets have a flux index of less than $50 \text{ kG}^2 \text{ mm}^2$, as measured by the procedures for determining the magnetic attractive force described in ASTM F963.¹²⁶ Because these requirements already apply to magnets used in products marketed as toys for children, the rule essentially extends the magnet size and strength requirements for toys to the subject magnet products. The draft proposed rule would not apply to magnet products intended for education and research and/or home and kitchen (such as shower curtains and magnetic closures) purposes, which do not also fit the criteria of the subject magnet products; for example, a magnet product intended only for education/research at a university, and not intended for amusement or jewelry, would be excluded from the scope of the draft proposed rule.

¹²⁵ The small parts cylinder referenced in the draft proposed rule is specified in 16 CFR part 1501—Method for Identifying Toys and Other Articles Intended for Use by Children Under 3 Years of Age Which Present Choking, Aspiration, or Ingestion Hazards Because of Small Parts.

¹²⁶ The flux index (magnetic force) of a magnet is calculated by multiplying the square of the magnet's surface flux density (in KGauss) by its maximum cross-sectional area (in mm^2).

B. Reasons the Commission is Considering a Mandatory Safety Standard

The CPSC has collected information regarding growing numbers of injuries with, and hazards posed by, hazardous magnets in consumer products. Detailed in the Directorate for Engineering Sciences, Division of Human Factors (ESHF) memorandum, where the type of product was indicated in incident reports, the majority of magnet ingestion incidents involved magnets used for amusement or jewelry at the time of ingestion, including from products that do not fall under the toy standard. Many of these ingestions resulted in surgical removal of magnets and surgical repair of injuries,¹²⁷ and others required non-surgical medical interventions, such as emergency endoscopies and colonoscopies. Reported magnet ingestions have involved young children, who put the magnets in their mouths, and adolescents and teens who experimented with the sensation of magnets (*e.g.*, attached magnets to their braces) or paired magnets to mimic tongue or lip piercings. If ingested, some magnets, as a consequence of their properties, are powerful enough to interact internally with one another through body tissue, and resist natural bodily forces to separate the magnets. Detailed in the Directorate for Health Sciences (HS) memorandum, this interaction has led to serious injuries and deaths, typically by causing intestinal twisting (volvulus injuries), fistulae, and perforations (Stabley, 2021, TAB A). In total, Staff is aware of seven deaths involving the ingestion of hazardous magnets between November 24, 2005 and January 5, 2021, five of which occurred in the U.S. and two abroad.¹²⁸ Regarding the deaths in the U.S., one death involved a children’s toy magnet building set, one death involved unspecified magnets, one death involved a magnet set, and two deaths involved magnets from unknown products; however, the magnets in these two unknown products were similar, if not identical, to magnets typically found in magnet sets. One of these unknown products was described as a magnet fidget toy building set, which is a common description for magnet sets. As detailed in CPSC staff’s 2020 Informational Briefing Package Regarding Magnet Sets,¹²⁹ CPSC staff finds that the internal interaction hazard is a hidden hazard, which is unlikely to be anticipated, appreciated, and avoided by children and caregivers, and which is unlikely to be addressed effectively without performance requirements limiting the size, strength, or both, of magnets in these types of products.

Staff of the Division of Hazard Analysis, Directorate for Epidemiology (EPA; Topping, 2021, TAB B) derived national estimates of injuries treated in emergency departments (ED) from the CPSC’s National Electronic Injury Surveillance System (NEISS). Table 1 below provides *annual* estimates of the injuries and the societal costs associated with ingestions of products categorized as amusement/jewelry, subjects of the draft proposed rule. As shown in Table 1, the 2017 through 2020 NEISS estimates suggest an estimated *annual* average of about 437 ED-treated injuries, comprised of 278 injuries that were treated and released and 159 injuries that required hospitalization. Additionally, based on estimates from the Commission’s Injury Cost

¹²⁷ ESHF reports: “At least 124 CPSRMS incidents resulted in some form of surgery (including laparoscopy, laparotomy, appendectomy, cecostomy, enterotomy, colostomy, cecectomy, gastrotomy, jejunostomy, resection, and transplant)” (Harsanyi, 2021, TAB C).

¹²⁸ Two of the seven deaths occurred abroad (one in Australia in 2011 and one in Poland in 2014). Each of these deaths involved magnets from unknown products; however, the magnets were similar, if not identical, to magnets typically found in magnet sets.

¹²⁹ CPSC staff’s informational briefing package regarding magnet sets, “Staff Briefing Package in Response to Petition CP 17-1, Requesting Rulemaking Regarding Magnet Sets,” dated June 3, 2020.

Model (ICM), 164 injuries were treated outside of hospitals annually and another 77 injuries resulted in direct hospital admission.

Based on ICM estimates, these injuries resulted in annual societal costs of about \$47.6 million (in 2018 dollars) during the 2017 through 2020 time period. Analysis of costs of injuries and estimated numbers of subject magnet products in use suggests that the present value of expected hazard costs over the expected product life are greater than \$150 per unit. These estimates exclude cases involving unidentified magnet products; therefore, to the extent that the unidentified magnet products were products that would be covered by the draft proposed rule, the societal costs may be substantially greater. Details about estimated societal costs associated with ingestions of subject magnet products may be found in the preliminary regulatory analysis (Smith, 2021, TAB E).

Table 1.
Estimated average annual medically treated injuries and associated societal costs for magnet ingestions for which identifying product information was reported (i.e., magnets from magnet sets, magnet toys, or jewelry) 2017 -- 2020.

Injury Disposition	Estimated Number	Estimated Societal Costs (\$ millions)*
Doctor / Clinic	164	\$ 2.2
Treated and Released from Hospital Emergency Department (ED)	278	\$ 6.2
Admitted to Hospital Through the ED (NEISS)	159†	\$ 26.4
Direct Hospital Admissions, bypassing the ED	77	\$12.8
Total Medically Attended Injuries	678	\$47.6

* In 2018 dollars.

† According to the Directorate for Epidemiology, the estimated number of hospital-admitted, ED-treated injuries is a not a reliable estimate because of the small number of cases upon which the estimate was based.

C. Objectives of and Legal Basis for the Draft Proposed Rule

The purpose of the draft proposed rule is to reduce the risks of death and serious injury from ingestion of hazardous magnets by preventing the sale of one or more loose or separable hazardous magnets in the subject magnet products. As noted above, if ingested, hazardous magnets, as a consequence of their properties, are powerful enough to interact internally with one another through body tissue, and resist natural bodily forces to separate the magnets. Detailed in the Directorate for Health Sciences (HS) memorandum, this interaction has led to deaths and serious injuries, typically by causing intestinal twisting (volvulus injuries), fistulae, and perforations (Stabley, 2021, TAB A).

The rule is being proposed under the authority of Sections 7 and 9 of the Consumer Product Safety Act (CPSA).

D. Small Businesses to which the Draft Proposed Rule Will Apply

The draft proposed rule would affect firms or individuals that manufacture, import and sell subject magnet products: products with one or more magnets, which are loose or separable, and designed, marketed, or intended to be used by consumers for entertainment, jewelry (including children's jewelry), mental stimulation, stress relief, or a combination of these purposes. Examples of the subject magnet products marketed by these businesses include magnet sets for users 14 years and older,¹³⁰ other types of magnet toys marketed to users 14 years and older, and jewelry with separable magnets that can be arranged by the consumer. Manufacturers and sellers of jewelry with non-removable magnets, such as necklaces with magnetic clasps or "magnetic therapy" jewelry with firmly-attached magnets, would not be subject to the draft proposed rule.

Because CPSC's previous rulemaking work regarding magnet ingestions has focused on magnet sets, CPSC staff has more detailed information about magnet sets than other subject magnet products. For this reason, this memorandum provides detailed information about magnet sets; however, staff also provides information about additional subject magnet products, to the extent information about these products is available.

All of the importers of magnet sets are small businesses under U.S. Small Business Administration (SBA) size standards, and we expect this is also true for manufacturers and importers of other subject magnet products, such as jewelry with loose/separable magnets. At this time, it appears that nearly all of the current marketers (firms or individuals) of magnet sets sell through Internet sites, rather than through "brick-and-mortar" retailers such as book stores, gift shops and other outlets (which commonly sold magnet sets during 2009 through mid-2012).¹³¹ Some of these Internet sites are operated by the importers, but the great majority of sellers (in terms of distinct firms or individuals, if not unit sales) appear to sell through their stores operated on the sites of other Internet platforms. These online retail outlets may also be commonly used by manufacturers and sellers of other subject magnet products, such as jewelry with loose or separable magnets.

An examination of the market for magnet sets was undertaken for the CPSC late in 2018 by Industrial Economics, Incorporated (IEc). IEc's review of magnet sets offered for sale on these Internet platforms late in 2018 found a total of 69 sellers (IEc, 2019, p. 5). IEc also identified 10 manufacturers and two retailers, which also are small businesses.¹³² EC provided IEc with a spreadsheet of our prior research which identified at least 121 sellers of magnet sets

¹³⁰ Magnet sets are a subset of the subject magnet products, which are aggregations of separable magnetic objects that are marketed or commonly used as a manipulative or construction item for entertainment, such as puzzle working, sculpture building, mental stimulation, or stress relief.

¹³¹ Internet searches on February 3, 2020, found that magnet sets were being offered for sale on Internet sites operated by retailers with brick-and-mortar stores. However, a subsequent review of such sites on March 4, 2020, did not find the magnet sets were being offered for sale.

¹³² IEc classified manufacturers as firms producing and selling their own magnet set products, and retailers as firms that typically sell magnets from multiple manufacturers (IEc, 2019, p. 4).

on two major Internet retailing platforms. IEC reviewed these sellers with the intention of merging CPSC's research with newer information. IEC "... discovered that the vast majority of sellers recorded by CPSC for one of the platforms were no longer selling relevant magnet set models. Further, more than half of the stores on the other leading platform no longer sold relevant magnet set models. [IEC's] review confirms that these marketplaces have high turnover rates for magnet set products offered on the sites (IEC, 2019, p. 8).

In 2020, EC reviewed the status of previously identified sellers of magnet sets on two major Internet platforms and found further evidence of the high turnover rates: most of the sellers identified in later 2018 had either ceased selling magnet sets, or had abandoned their stores. We found that only 9 of 69 sellers were still selling magnet sets. The remaining sellers either no longer offered magnet sets or no longer operated on the platforms. However, we did identify 29 new sellers on the platforms that were not identified by IEC as being active in the market late in 2018. This gives further evidence of the high turnover rate among retail sellers of magnet sets.

Although the locations of the sellers on major internet retailing platforms have not always been clear, many appeared to have been located in China. EC's 2018 review of the market found that about 57 percent of magnet set sellers on one platform (foreign and domestic) had their orders fulfilled by domestically-located centers. Our 2020 review found 16 current sellers on one major Internet platform, most of which appeared to have been located in China; 4 current sellers (25%) had orders fulfilled by the platform. Our 2020 review of magnet sets of interest on another major Internet retailing platform found that of 18 sellers, 13 (87%) were located in the United States.¹³³ This was an apparent shift from 2018, when we found that a substantial majority of sellers (75%) on the platform were located in China or Hong Kong. Six new sellers of magnet sets were found in a recent (June & July 2021) review of the platform by EC (4 domestic and 2 in China).

In addition to the use of Internet retailers based in the United States, U.S. consumers may also purchase a wide variety of magnet sets using online retailers based in China. Magnet sets purchased from foreign Internet retailers may be shipped to U.S. consumers directly from China or from warehouse facilities located domestically.

Magnet sets currently offered for sale are comprised of spheres or cubes in a range of dimensions and numbers of individual magnets. Magnet sets seen in our review of the market mainly were comprised of 216 magnetic spheres, with diameters of 5 mm.¹³⁴ Retail prices average under \$20 per set. IEC's market review in late 2018 had similar findings.¹³⁵ Magnet sets are also available in larger sets of 512 magnets and 1,000 or more.

¹³³ Several stores selling magnet sets on one major Internet retailing platform appeared to have been operated by the same individuals, based on locations and prices. In these cases, multiple stores were not counted as distinct sellers.

¹³⁴ Our 2018 review of the market found high-powered magnet sets for sale ranging from 20 or fewer spheres up to 1,728 spheres.

¹³⁵ IEC found that magnet sets with 216 magnets accounted for approximately one-third of the models in their market research, with an average price of \$16.67 (IEC, 2019, p. 7). However, sets of 216 magnets that measured 5 mm in diameter averaged

Magnet sets comprised of spheres or cubes with smaller dimensions (2.5 mm to 3 mm) are also marketed, typically at lower prices. Recent testing of samples of such smaller magnets by staff of the Directorate for Laboratory Sciences (and reported by ESMC) found that many 2.5 mm magnets had flux indices of less than 50 kG² mm², and others were greater; magnets with 3 mm diameters were found to have flux indices somewhat above 50 kG² mm (Paul, 2021, TAB D).

EC expects the dominant business model for importers of magnet sets will be direct sales to consumers using their own Internet websites or other Internet shopping sites; however, the draft proposed rule could also affect some third-party retailers of the products, whether selling them online or physically in “brick & mortar” stores, such as bookstores, gift shops, or stores that sell novelty items. Such retailers sell a wide variety of consumer products, and to the extent that retailers which would be classified as small businesses sell the products, these firms would not be likely to derive significant proportions of total revenues from sales of affected magnet sets, and the impacts on individual firms should be minimal.

Jewelry, and other types of adult¹³⁶ magnet products intended for amusement, which have one or more separable/loose magnets are within the scope of the draft proposed rule. Such products are also likely to be imported, and all firms importing these other subject magnet products are likely to be small businesses, according to SBA size standards (under 100 employees).

E. Projected Reporting, Recordkeeping, and Other Compliance Requirements of the Draft Proposed Rule

As stated above, the draft proposed rule would prohibit the manufacture, import and sales of products with one or more, loose or separable hazardous magnets, which are designed, marketed, or intended, to be used by consumers for entertainment, jewelry (including children’s jewelry), mental stimulation, stress relief, or a combination of these purposes. Under the draft proposed rule, subject magnet products would not comply with the standard if both of the following exist: (1) the individual magnets are small enough to fit entirely into the CPSC’s small parts cylinder; *and* (2) the individual magnets have a flux index of greater than or equal to 50 kG² mm², as measured by the procedures for determining the magnetic attractive force described in the toy standard.

Section 14(a)(1) of the CPSA requires manufacturers, importers, or private labelers of a consumer product (that is not a children’s product) subject to a consumer product safety rule to certify, based on a test of each product or a reasonable testing program, that the product complies with all rules, bans or standards applicable to the product. The draft proposed rule specifies the procedure to use to determine whether a subject magnet product complies with those requirements. For those products that manufacturers certify based on a test of each product or a reasonable testing program, manufacturers would issue a general certificate of conformity (GCC). Section 14(a)(2) of the CPSA requires manufacturers, importers, or private labelers of any product subject to a children’s product safety rule to submit sufficient samples of the

¹³⁶ Although CPSC generally considers “adults” to be age 18 years and older, in this memorandum, “adults” is used to refer to products intended for consumers ages 14 years and older, because these products are not subject to the existing regulation for children’s toys (ASTM F963 mandated by 16 CFR part 1250).

children's product, or samples that are identical in all material respects to the product to a CPSC-accepted third party conformity body for testing. Based on passing test results from the CPSC-accepted third party conformity body the manufacturer, importer, or private labeler issues a Children's Product Certificate (CPC) indicating the children's product is compliant with the children's product safety rule. For example, in the case of subject magnet products that could be considered to be children's products, such as children's jewelry, the CPC must be based on testing by a CPSC accepted third-party conformity assessment body.

Both GCCs and CPCs are required to meet certain requirements for certificates. Among the other requirements, each certificate must identify the manufacturer or private labeler issuing the certificate and any third-party conformity assessment body on whose testing the certificate depends, the date and place of manufacture, the date and place where the product was tested, each party's name, full mailing address, telephone number, and contact information for the individual responsible for maintaining records of test results. The certificates must be in English. The certificates must be furnished to each distributor or retailer of the product and to the CPSC, if requested.

F. Costs of the Draft Proposed Rule that Would be Incurred by Small Manufacturers

Small manufacturers /importers of subject magnet products would likely incur some additional costs to certify that their products meet the requirements of the draft proposed rule as required by Section 14 of the CPSA. The certification must be based on a test of each product or a reasonable testing program. The costs of the testing might be minimal, especially for small manufacturers that currently have product testing done for products subject to the requirements in ASTM F963, *Standard Consumer Safety Specification for Toy Safety*, which is mandated by 16 CFR part 1250. Importers may also rely upon testing completed by other parties, such as their foreign suppliers, if those tests provide sufficient information for the manufacturers or importers to certify that the magnets in their products comply with the draft proposed rule. As noted above, for subject magnet products that could be considered to be children's products, such as children's jewelry, the certification must be based on testing by an accredited third-party conformity assessment body, at somewhat higher costs.

CPSC staff welcomes comments from the public regarding the costs or other impacts of the certification requirements under Section 14 of the CPSA.

G. Impact on Small Businesses

As discussed in the preliminary regulatory analysis for the draft proposed rule (Smith, 2021; Tab E), the main impact on small businesses of the proposed rule would be the lost income and profits to firms that could not produce, import, and sell non-complying products in the future. The lost benefits to firms resulting from a proposed rule are measured by a loss in what is called *producer surplus*. Producer surplus is a measure of the total revenue of firms selling the magnets, less the total variable costs of production. As predominantly imported products, the variable costs for small businesses handling subject magnets are mainly the import costs. The producer surplus for magnet sets could average about \$5 to \$10 per unit, based on an average price of \$20. A similar relationship could apply to other subject magnet products affected by the draft standard, such as jewelry with separable magnets (Smith, 2021, Tab E).

A few small firms whose businesses focus on sales of magnet products that would not comply with the draft proposed rule, including some of the firms selling products on their own websites, would face relatively greater losses in producer surplus. These and other small businesses could respond to the rule by measures such as marketing or incorporating magnets that comply with the rule or increased marketing products that do not have loose or separable magnets. Such measures could partially offset losses in producer surplus resulting from firms' inability to continue marketing noncomplying magnet products.

H. Other Federal Rules

The staff is not aware of any Federal rules that may duplicate, overlap, or conflict with the draft proposed rule.

I. Alternatives to the Draft Proposed Rule

The RFA requires the agency to consider alternatives that would reduce the burden of the draft proposed rule. At a minimum, the agency must consider (1) the establishment of different compliance or reporting requirements for small entities or timetables that take into account the resources available to small entities, (2) clarification, consolidation, or simplification of compliance and reporting requirements for small entities, (3) the use of performance rather than design standards, and (4) an exemption for certain or all small entities from coverage of the rule, in whole or in part.

As discussed in the analysis above, all domestic firms that are expected to manufacture or import subject magnet products are small businesses. Therefore, alternative requirements for small manufacturers/importers would simply be alternatives to the draft proposed rule itself. Some such alternatives are discussed below. An exemption for small manufacturers/importers is not possible because all manufacturers/importers that would be subject to the rule are small.

CPSC staff has considered several alternatives that reduce the impact of a rule on small businesses. These alternatives are discussed below.

a) Adoption of Alternative Performance Requirements

As an alternative to the draft proposed rule, the Commission could consider promulgating an alternative set of requirements that are less stringent than the draft proposed rule. For example, some alternatives might include: setting a different flux index for the subject magnets; requiring different specifications for shapes and sizes of magnets within the scope of the standard; or setting forth some other criteria that have not yet been developed.

Such alternatives could reduce the burden on small entities because they would allow the firms to market a wider variety of products than allowed under the draft proposed rule. The same alternatives could benefit consumers because a wider variety of products would be available for their use. However, these options would also reduce the expected benefits of a rule, because hazardous magnets would still be available in certain products that staff has determined children may access and use consistent with known hazard patterns.

Neither the costs nor benefits of these alternative sets of requirements are quantifiable with available information. They would depend upon the specific requirements of the rule, consumer acceptance of the product, and the risk of injury associated with the re-designed magnets. It may be difficult to set requirements for the magnets that would make the magnets viable for the variety of their intended uses while at the same time substantially reducing the risk to children. CPSC staff would welcome public comments on whether alternative, less stringent, requirements could be developed that would adequately reduce the hazards associated with the ingestion of magnets but also allow for the variety of magnets available and their utility to consumers.

b) Different (Longer) Effective Date

CPSC staff recommends that the draft proposed rule take effect 180 days after a final rule is published in the Federal Register. A possible alternative to reduce the impact of the rule on smaller manufacturers/importers would be extending the period before the rule becomes effective. This could give firms additional time to develop complying products, or to shift marketing to nonmagnetic products. Staff seeks comments on the advantages and disadvantages to a different effective date.

c) Requiring Safer Packaging

The Commission could require subject magnet products with hazardous magnets to be sold with special storage containers, which help limit access to the magnets by younger children. For example, special packaging may incorporate child-resistant (CR) features, help consumers determine if all magnets have been collected, or both. The costs of this alternative would depend upon the packaging requirements, but the burden on small businesses would be substantially less costly than the draft proposed rule because it would allow small businesses to continue to sell the subject magnet products with loose/separable hazardous magnets. It seems unlikely that the costs of the safer packaging would amount to more than a dollar or so per magnet product, though these costs might be somewhat higher if child resistant packaging was required.

In Tab C, ESHF staff provides an assessment of these measures, and concludes that packaging requirements are unlikely to be adequate methods by which to address effectively the internal interaction hazard associated with these products. Among other factors detailed, CR features would not prevent access to hazardous magnets by the majority of ages historically involved in magnet ingestion incidents, and both CR features and features that afford visual verification of all magnets from the product, depend on an unrealistic expectation that the small magnets will be located and repackaged in their entirety, and correctly, after every use (Harsanyi, 2021, TAB C).

d) Requiring Warnings

The Commission could require strong safety messaging pertaining to the hazard and intended users, such as in warning labels and instructional literature. For example, there is a relatively new standard on adult magnet sets, ASTM F3458 – 21, *Standard Specification for Marketing, Packaging, and Labeling Adult Magnet Sets Containing Small, Loose, Powerful*

Magnets (with a Flux Index $\geq 50 \text{ kG}^2 \text{ mm}^2$), which includes safety messaging requirements pertaining to hazardous magnets in magnet sets intended for ages 14 and older. This alternative would reduce the burden on small firms because it would allow them to continue to sell the subject magnet products with loose/separable hazardous magnets and the costs of such warnings would most likely be small.

In Tab C, staff provides an assessment of safety messaging for the subject magnet products, and concludes that safety messaging is unlikely to effectively address the internal interaction hazard associated with these products (Harsanyi, 2021, TAB C). Among other factors detailed, strong and repeated warnings in labels, instructions, and public outreach efforts, which explain the internal interaction hazard and to keep the magnets away from children, have historically been unable to adequately reduce the likelihood of magnet ingestion. The effectiveness of warnings depends on convincing consumers to avoid the hazard, and there are numerous reasons consumers may disregard warnings for these products. They are particularly unlikely to anticipate and appreciate the risk of magnet ingestion by children and teens absent a history of mouthing inedible objects.

e) Requiring Aversive Agents

The Commission could require manufacturers to coat loose or separable hazardous magnets in the subject magnet products with aversive agents, such as foul odors or bitterants. The desired effect of these approaches is to make the magnets less appealing for children and teens to put in their mouths. This alternative would reduce the burden on small firms because it would allow them to continue to sell the subject magnet products with loose/separable hazardous magnets and the costs of such coatings would likely be small.

In Tab C, staff explains that aversive agents, such as foul odors or bitterants, may dissuade some children and teens from placing hazardous magnets into their mouths; however, ultimately, such features would not be effective universally, and CPSC has found that aversive agents do not adequately deter or prevent ingestions. Although the use of aversive agents might discourage some children from placing additional magnets in their mouths, incident reports indicate that serious injury is possible when one ingests as few as two magnets, or one magnet and a ferromagnetic object, and children might ingest multiple magnets before they detect the aversive agent.

f) Relying on ASTM Activities

Rather than proceeding with rulemaking, the Commission could assess ongoing ASTM activities pertaining to hazardous magnets in consumer products. Detailed in Tab C, there appears to be interest in the ASTM F15.77 subcommittee on magnets to devise performance requirements for adult magnet sets, including limitations in size and strength. Such requirements might address the internal interaction hazard for the most concerning type of subject magnet product (magnet sets); however, there are considerable risks for delaying staff's draft proposed rule, including the following: (1) it is unknown if and when the ASTM standard will incorporate adequate performance requirements, (2) the rate of compliance with the ASTM standard is unknown, and (3) the product scope is limited to magnet sets, and may be further limited for

performance requirements (such as specific shapes of magnets), and therefore may not adequately address the hazard (while magnet sets are a particular concern, the majority of incidents involve uncertain magnet products, including magnets described as jewelry).

III. Summary

The results of this initial regulatory flexibility analysis suggest that the draft proposed rule could have a significant adverse impact on a few small importers of magnet sets which are believed to receive nearly all of their revenues from sales of subject magnet products. Some possible alternatives to the draft proposed rule have been identified. All of these alternatives would reduce the expected impact of the rule on small businesses. However, these alternatives would not achieve the same level of benefits as the draft proposed standard. CPSC staff would welcome public comments on the number of small entities that would be impacted by the draft proposed rule, annual sales of the subject magnet products, the potential impacts of the draft proposed rule on small businesses, and potential alternatives that could reduce the burden on small businesses while still achieving the safety objectives of the draft proposed rule.

IV. References

- Harsanyi, S. (2021, July). Staff Analysis Report: Human Factors Assessment of Hazardous Magnet Products. Directorate for Engineering Sciences, Division of Human Factors (ESHF), CPSC. Bethesda, MD. (TAB C in the NPR briefing package)
- Israel, J., Cahill, A., and Baxter, J. (2019). Report: Final high-powered magnet set market research report. Cambridge, MA: Industrial Economics, Incorporated (IEc).
- Paul, C. (2021). Staff Analysis Report: Recommended Performance Requirements to Address Ingestion Injuries Associated with Hazardous Magnets. Directorate for Engineering Sciences, Division of Mechanical and Combustion Engineering (ESMC), CPSC. Bethesda, MD. (TAB D in the NPR briefing package)
- Smith, C. (2021, July). Staff Analysis Report: Preliminary regulatory analysis of a rule that would establish a standard for hazardous magnet products. Directorate for Economic Analysis (EC), CPSC. Bethesda, MD. (TAB E in the NPR briefing package)
- Stabley, J. (2021, July 20). Staff Analysis Report: Health outcomes following exposure to hazardous magnets and associated medical considerations. Directorate for Health Sciences, Division of Pharmacology and Physiology Assessment), CPSC. Bethesda, MD. (TAB A in the NPR briefing package)
- Topping, J. (2021, July23). Staff Analysis Report: NEISS injury estimates and analysis of reported incidents related to ingestion of magnets. Directorate for Epidemiology, Division of Hazard Analysis (EPHA), CPSC. Bethesda, MD. (TAB B in the NPR briefing package)
- U.S. Small Business Administration (SBA) (2016). *Table of Small Business Size Standards Matched to North American Industry Classification System Codes*. Retrieved from http://www.sba.gov/sites/default/files/files/Size_Standards_Table.pdf.

TAB G: Summary of Recalls Involving Small, Powerful Magnets January 1, 2010 through August 17, 2021



UNITED STATES
CONSUMER PRODUCT SAFETY COMMISSION
BETHESDA, MARYLAND 20814

Memorandum

Date: September 12, 2021

To: Stephen Harsanyi
Hazardous Magnet Products Project Manager
Directorate for Engineering Sciences

Through: Robert S. Kaye, Assistant Executive Director
Office of Compliance and Field Operations

From: Michelle Guice, Compliance Officer, Children's Product Team
Office of Compliance and Field Operations

Subject: Summary of Recalls Involving Small, Powerful Magnets – January 1, 2010 through August 17, 2021

This summary is being provided in support of the recommended notice of proposed rulemaking ("NPR") for small, powerful ("hazardous") magnets.

The table below (Table I) represents recalls that involved these magnets. The Office of Compliance conducted eighteen recalls between January 1, 2010 and August 17, 2021, and notes the recall dates, the firms involved, hazard(s), the approximate number of units affected, number of reported incidents/injuries¹³⁷ and the press release numbers. Two of the recalls involved products that violated the Standard Consumer Safety Specification for Toy Safety, ASTM F963, Section 4.38, Magnets, which is required by 16 CFR part 1250, and applies to children's toys. Those recalls were for Maxfield and Oberton LLC's Buckyballs® High Powered Magnets Sets recalled on May 27, 2010 and Sobeauty Inc.'s "Mag Cube" Magnetic Ball Sets recalled on June 27, 2019. Two additional recalls also involved children's toys subject to ASTM F963 that contained small magnets—Juratoys' fishing games, recalled on September 10, 2015, and Target's magnetic tic tac toe games, recalled on March 29, 2017. Children's toys are not subject to the recommended NPR since they are subject to ASTM F963, however, they are included in Table I because they involved small or hazardous magnets and the ingestion hazard that the recommended NPR aims to address. One other recall that involved hazardous magnets that are not subject to the NPR, was for Tristar Products' Magnetic Trivets that were sold with cookware sets, recalled on July 30, 2019.

No deaths were reported in any of the eighteen recalls.

¹³⁷ Various recalls in 2012 and 2013 state "CPSC has received 80 reports of incidents involving ingestion of other high-powered magnets, resulting in 79 reports seeking medical intervention."

TABLE I – Summary of Recalls Involving Hazardous Magnets.

Recall Date	Firm	Hazard	Number of Recalled Units	Number of Incidents Reported (Injuries Reported)	Press Release Number
May 27, 2010	Maxfield and Oberton LLC	Aspiration and Intestinal Perforations or Blockages	About 175,000 Buckyballs® High Powered Magnets Sets	Two Reports of Children Swallowing One or More Magnets/ No Injuries Reported	10-251 ¹³⁸
November 21, 2012	Jo-Ann Fabric and Craft Stores	Magnets Can Become Loose - Ingestion Hazard for Children	About 1,800 Foam Pumpkin Turkey Craft Kit	No Incidents/Injuries Reported	13-046 ¹³⁹
December 10, 2012	Reiss Innovations	Aspiration and Intestinal Perforations or Blockages	About 500 High-Powered Magnet Desk Toy; DynoCube	No Incidents/Injuries Reported	13-062 ¹⁴⁰
January 31, 2013	SCS Direct	Intestinal Obstructions, Perforations, Sepsis and Death	About 106,000 Magnet Balls® Manipulative Magnet Sets	No Incidents/Injuries Reported	13-112 ¹⁴¹
January 31, 2013	Kringles Toys and Gifts	Intestinal Obstructions, Perforations, Sepsis and Death. Internal.	About 4,200 Nanospheres Magnetic Desk Toys	Firm Received No Reports of Incidents or Injury	13-111 ¹⁴²

¹³⁸ <https://cpsc.gov/Recalls/2010/Buckyballs-High-Powered-Magnets-Sets-Recalled-by-Maxfield-and-Oberton-Due-to-Violation-of-Federal-Toy-Standard>

¹³⁹ <https://cpsc.gov/Recalls/2013/Jo-Ann-Fabric-and-Craft-Recalls-Foam-Pumpkin-Turkey-Craft-Kit-Due-to-Risk-of-Magnet-Ingestion-Hazard>

¹⁴⁰ <https://cpsc.gov/Recalls/2013/High-Powered-Magnet-Sets-Recalled-by-Reiss-Innovations-Due-to-Ingestion-Hazard-Sold-Exclusively-on-Amazoncom>

¹⁴¹ <https://cpsc.gov/Recalls/2013/High-Powered-Magnet-Balls>

¹⁴² <https://cpsc.gov/Recalls/2013/Kringles-Toys-and-Gifts-Recalls-High-Powered-Magnets>

April 12, 2013	Six Retailers: Barnes & Noble, Bed Bath & Beyond, Brookstone, Participating Hallmark Retailers, Marbles the Brain Store and, ThinkGeek	These Products Contain Defects in the Design, Warnings and Instructions, which Pose a Substantial Risk of Injury and Death to Children and Teenagers	About 3,000,000 sets of Buckyballs and Buckycubes	CPSC received 54 Reports of Children and Teens Ingesting This Product, with 53 of These Requiring Medical Interventions	13-168 ¹⁴³
April 15, 2013	Overstock.com	Intestinal Obstructions, Perforations, Sepsis and Death	539 Buckyballs high-Powered Magnet Sets	No Injuries Reported	13-731 ¹⁴⁴
April 15, 2013	Toys R Us	Intestinal Obstructions, Perforations, Sepsis and Death	About 60 Buckyballs High-Powered Magnet Sets	No Injuries Reported	13-732 ¹⁴⁵
June 7, 2013	Adobe	Intestinal Obstructions, Perforations, Sepsis and Death	About 500 High-Powered Magnets distributed with Adobe Connect™ "Effective Collaboration is Magnetic" Promotional Materials Package	No Incidents/Injuries Reported	13-736 ¹⁴⁶
March 6, 2014	Design Ideas	Intestinal Obstructions, Perforations, Sepsis and Death	About 21,700 Rubber Ducky Magnets, 3,200 Blowfish Magnets and 2,000 Splat Magnets	No Incidents/Injuries Reported	14-126 ¹⁴⁷

¹⁴³ <https://cpsc.gov/Recalls/2013/Six-Retailers-Announce-Recall-of-Buckyballs-and-Buckycubes-High-Powered-Magnet-Sets>

¹⁴⁴ <https://cpsc.gov/Recalls/2013/Overstock-Recalls-High-Powered-Magnet-Sets>

¹⁴⁵ <https://cpsc.gov/Recalls/2013/Toys-R-Us-Recalls-High-Powered-Magnet-Sets>

¹⁴⁶ <https://cpsc.gov/Recalls/2013/Adobe-Recalls-High-Powered-Magnets-Distributed-with-Promotional-Materials-Package>

¹⁴⁷ <https://cpsc.gov/Recalls/2014/Design-Ideas-Recalls-Magnets>

August 5, 2015	Disney Store	The Magnets Can Detach, Posing an Ingestion Hazard. These Magnets can Link Together if Swallowed & Result in Serious Internal Injuries	About 300 Gadget Pencil Cases	No Incidents/Injuries Reported	15-745 ¹⁴⁸
September 10, 2015	Juratoys U. S	The small Magnet Inside the Worm can Liberate. Swallowing Multiple Magnets Can Result in Serious Internal Injury.	About 14,000 (about 200 in Canada) Sardines Fishing Game & Starfish Fishing Game	417 Reports of the Plastic Worm at the end of the Fishing Pole Line Separating and Releasing Small Parts, Including Four Reports of Children Ingesting a Small Part/ No injury reported.	15-241 ¹⁴⁹ⁱ
May 17, 2016	Pacific Cycle	Magnetic Buckle on helmet's chin strap contains small plastic covers & magnets that can come loose; posing a risk of choking and magnet ingestion to young children.	About 129,000 Infant Bicycle Helmets with Magnetic No-Pinch Buckle Chin Strap	Pacific Cycle Received Three Reports of the Plastic Cover Coming Loose. No Injuries Reported.	16-162 ¹⁵⁰
August 4, 2016	Cinmar, LLC	Intestinal Obstructions, Perforations, Sepsis and Death effects.	About 4,500 Magnetic travel maps	No Incidents/Injuries Reported	16-766 ¹⁵¹
March 29, 2017	Target	Intestinal Obstructions, Perforations, Sepsis and Death	About 19,000 Magnetic tic tac toe games	Target Received One Report of the Magnets Falling Off the Game Piece /No Injuries	17-119 ¹⁵²ⁱⁱ

¹⁴⁸ <https://cpsc.gov/Recalls/2015/Disney-Store-Recalls-Pencil-Cases>

¹⁴⁹ <https://cpsc.gov/Recalls/2015/Juratoys-Recalls-Fishing-Games>

¹⁵⁰ <https://cpsc.gov/Recalls/2016/Pacific-Cycle-Recalls-Infant-Bicycle-Helmets>

¹⁵¹ <https://cpsc.gov/Recalls/2016/Cinmar-Recalls-World-Magnetic-Travel-Maps>

¹⁵² <https://cpsc.gov/Recalls/2017/Target-Recalls-Magnetic-Tic-Tac-Toe-Games>

July 30, 2019	Tristar Products	Intestinal Obstructions, Perforations, Sepsis and Death	About 350,000 Magnetic Trivets	One report of Magnets Detaching from a Trivet and Swallowed by a Child. The Child Suffered Intestinal Perforations and Blockage, Requiring Surgery	19-765 ¹⁵³
June 27, 2019	Sobeauty Inc.	Intestinal Obstructions, Perforations, Sepsis and Death	About 600 "Mag Cube" Magnetic Ball Sets	No Incidents/Injuries Reported	20-741 ¹⁵⁴
August 17, 2021	Zen Magnets LLC	Perforations, twisting and/or blockage of the intestines, infection, blood poisoning, and death.	About 10 million Zen Magnets and Neoballs Magnets, sold individually and in magnet sets	Two children ingested Zen Magnets and required surgery to remove the magnets and parts of their intestines and bowels. CPSC is aware of other reports of children and teenagers ingesting high-powered magnets and requiring surgery. A 19-month-girl died after ingesting similar high-powered magnets.	21-179 ¹⁵⁵

ⁱ This recall was for small parts where the embedded magnets could become loose and pose as choking hazards, not for violation of ASTM F963, Section 4.38, Magnets.

ⁱⁱ This recall was also for small parts and not for violating ASTM F963, Section 4.38, Magnets. The magnets could become loose and pose as potential choking hazards.

¹⁵³ <https://cpsc.gov/Recalls/2019/Tristar-Products-Recalls-Magnetic-Trivets-Due-to-Magnet-Ingestion-Hazard-Recall-Alert>

¹⁵⁴ <https://cpsc.gov/Recalls/2020/Sobeauty-Recalls-Mag-Cube-Magnetic-Ball-Sets-Due-to-Risk-of-Ingestion-by-Children-That-Could-Cause-Serious-and-Permanent-Intestinal-Injuries-or-Death-Recall-Alert>

¹⁵⁵ <https://cpsc.gov/Recalls/2021/Zen-Magnets-and-Neoballs-Magnets-Recalled-Due-to-Ingestion-Hazard>